

PR series User Manual - Full Version



BrainChild

UMFPR01E
5th Edition, 05/2018

TABLE OF CONTENTS

1. GENERAL DESCRIPTION	8
1.1 UNIQUE FEATURES OF RECORDER	8
1.2 COMPARISON OF PR SERIES RECORDERS	11
1.3 EXPANDABLE INPUT AND OUTPUT CARDS	12
1.4 COMMUNICATION.....	15
1.5 EXTERNAL STORAGE MEDIA.....	15
1.6 SMART MECHANISM	16
1.7 ORDERING CODES AND ACCESSORIES	17
1.7.1 PR10 Ordering code	17
1.7.2 PR20 Ordering code	19
1.7.3 PR30 Ordering code	22
1.7.4 PC201 Ordering code	24
1.7.5 Accessories:.....	25
1.8 SPECIFICATIONS.....	27
2. INSTALLATION AND WIRING.....	32
2.1 UNPACKING	32
2.2 INSTALLATION	32
2.3 PANEL MOUNTING STYLE	33
2.4 SETUP INPUT AND OUTPUT	41
2.5 WIRING OF THE CARDS	48
2.6 RS-232, RS-422, AND RS-485 WIRING	56
2.7 EXTERNAL MEMORY CARD:	57
3. BASIC FUNCTIONS OF RECORDERS	58
3.1 CONFIGURATION	58
3.2 STANDARD AND PLUS VERSION OF FIRMWARE	58
3.3 COMMUNICATION WITH THIRD PARTY INTERFACES.....	60
3.4 INFORMATION ACCESSIBILITY THROUGH WEB.....	60
3.5 HANDWRITING MESSAGES ON TREND SCREENS.....	61
3.6 CUSTOM EDITED DISPLAY SCREENS	65
3.7 ANALOG INPUT LOG SPEED FLEXIBILITY	66
3.8 HIGH SPEED INPUT	66
3.9 SYSTEM CLOCK SYNCHRONIZATION VIA INTERNET	66
3.10 INCREASED SECURITY IN PASSWORD CONFIGURATION	66
3.11 AUTO OUTPUT TO PRINTER	66
3.12 EXTERNAL CHANNELS	66

3.13	BATCH	66
3.14	FDA 21 CFR PART 11	66
4.	CONFIGURATION	67
4.1	CHANNEL	68
4.1.1	Analog Input	68
4.1.2	Digital Input	75
4.1.3	Math Channel	77
4.1.4	Analog Output	90
4.1.5	Digital Output	92
4.1.6	External	92
4.1.7	Jobs	93
4.2	DISPLAY	96
4.2.1	Display Modes	97
4.2.2	Status Bar	102
4.3	TIMER	103
4.4	CLOCK	106
4.5	COMMUNICATION	107
4.5.1	Connections	109
4.5.2	Commands	110
4.5.3	Modbus RTU Master, Example1	111
4.5.4	Modbus RTU Master, Example2	113
4.5.5	Modbus RTU Slave, Example	115
4.6	INSTRUMENT	117
4.7	SECURITY	118
4.7.1	Normal	118
4.7.2	CFR-21	119
4.8	DEMO	120
4.9	AUTO-OUTPUT	120
4.9.1	USB Printer	121
4.9.2	Network Printer (LPT1)	122
4.9.3	Print Historical data	124
4.9.4	Print Reports	126
4.9.5	Print Snapshot	127
4.10	SYSTEM INFO	128
4.11	BATCH CONTROL	131
4.12	CALIBRATE	138
4.13	PROCEDURE TO UPGRADE AND RESTORE FACTORY DEFAULT SETTINGS	156
5.	PC BASED SOFTWARE	158
5.1	FREE BASIC SOFTWARE	158

5.1.1	Requirements.....	158
5.1.2	Operating system.....	158
5.1.3	Software.....	158
5.1.4	Ethernet Configuration.....	162
5.1.5	Automatic export of data from historical viewer.....	167
5.2	DATA ACQUISITION STUDIO SOFTWARE	168
5.2.1	Requirements.....	168
5.2.2	Software.....	169
5.2.3	How to configure Communication Bank.....	169
5.2.4	How to configure Recorder	173
5.2.5	Touch Screen.....	173
5.2.6	Ethernet.....	173
5.2.7	Removable Media	177
5.2.8	Configuration.....	181
5.2.9	How to view Historical data.....	192
5.2.10	How to view Real time data in PC	199
5.2.11	Bank configuration	199
5.2.12	Ethernet.....	202
5.2.13	Serial (RS232/422/485)	205
5.2.14	View Real time data from Multiple Recorders.....	205
5.3	PANEL STUDIO VERSION	206
5.3.1	System Requirements.....	207
5.3.2	Software Installation.....	208
5.3.3	Project status	209
5.3.4	Create new project.....	210
5.3.5	Menu bar	211
5.3.6	File	212
5.3.7	Environment.....	213
5.3.8	Edit.....	215
5.3.9	Format.....	216
5.3.10	View	219
5.3.11	Objects.....	221
5.3.12	Project.....	222
5.3.13	Standard bar	222
5.3.14	Format bar	223
5.3.15	Project Explorer	224
5.3.16	Screen.....	225
5.3.17	Tool box	228
5.3.18	Enhanced Objects.....	286
5.3.19	Graphics.....	314

5.3.20	Symbol Factory	322
5.3.21	Project Tools	333
5.3.22	Build	333
5.3.23	Build & Offline Simulation	333
5.3.24	Stop	334
5.3.25	Build & Download.....	335
5.3.26	Download	335
5.3.27	Project status	337
6.	WEBSERVER.....	338
6.1	REQUIREMENTS.....	338
6.1.1	Hardware.....	338
6.1.2	Operating system.....	338
6.1.3	Browser Requirements	338
6.1.4	IP Address Requirements.....	339
6.2	HOW TO CONFIGURE WEB SERVER SETTINGS	339
6.2.1	How to Configure Static IP Address	340
6.2.2	How to Enable Web Server.....	341
6.3	HOW TO VIEW RECORDER DATA IN PC VIA WEBSERVER:	342

Safety

This recorder is compliant with the requirements of UL 61010C-1, CSA C22.2 No. 61010-1-12 and CE: EN61010-1 (IEC61010-1) over voltage category II, Pollution degree 2 (PR30 in process). The protection provided by the recorder may be impaired if it is used in a manner inconsistent with its intended purpose, or in an environment that exceeds the specifications of the recorder. Brainchild Electronic Co., Ltd. is not liable if the customer fails to comply with these requirements.

Safety Symbols

The following symbols may be seen in the user manual or on recorder labeling.



Caution



Protective Earth



DC Supply

Safety Notes and Precautions

1. Before any connection is made, the protective earth terminal should be connected first. To avoid making the recorder dangerous under fault conditions, any interruption of the protective Earth conductor inside or outside the recorder is prohibited. Even in the case of a portable unit, the protective earth terminal must remain connected if the recorder is connected to any hazardous voltage.
2. Keep signal and supply voltage wiring separated from one another. If this is impractical, use shielded cables for signal wiring. Double insulation should be used for signal wiring when the recorder is used with hazardous voltage.
3. Do not use the recorder where there is high vibration or a high magnetic field. This could cause damage or error of measurement.
4. All maintenance or repairs should be carried out with power disconnected to avoid personal injury or damage to the unit.
5. In areas with conductive pollution, adequate ventilation, filtering and sealing must be installed.
6. When cleaning the recorder, handle carefully and use soft dry cloth. Avoid the use of abrasives, or any sharp or hard objects which would damage the display.
7. Do not operate the recorder if any part has been removed or disassembled. Consult your nearest dealer at once.

Static Electricity

Appropriate precautions must be taken when handling the recorder. The circuit board components are susceptible to damage caused by electrostatic discharge. Take static electricity precautions while handling and inserting USB memory into the recorder.

**NOTE: IF THE USER REQUIRES TO QUICKLY OR BRIEFLY
KNOW DETAILS OF THE FUNCTIONS, PLEASE
REFER THE QUICK USER MANUAL**

1. General Description

1.1 Unique features of recorder

The PR series is a well-designed new generation paperless recorders with many outstanding features as follows:

Hardware

- Three sizes including 4.3", 5.6" and 12.1"
- PR10, with a 4.3" display, with 3 or 6 universal analog inputs and 24 Optional External Channels
- PR20, with a 5.6" display, with 6, 12, 18 or 24 universal analog inputs and 48 Optional External Channels
- PR30, with a 12.1" display, with 6, 12, 18, 24, 30, 36, 42 or 48 universal analog inputs and 96 Optional External Channels
- TFT Color LCD, Touch screen & high resolution
- 100 millisecond sample rate and data logging
- Process Control card (PC201) to control the process.
- High accuracy 24-bit A-D Analog Input
- 16-bit D-A Analog Output
- Digital input, maximum 100 Hz.
- Plug & play I/O cards (AI, AO, DI, DO) for easy expansion
- On-board SD card slot for Internal memory
- USB slot for external storage
- 171 mm short depth
- Ethernet as standard with optional RS-232 or RS422/RS485 communication
- Two USB Host ports for downloading the data or connect to Printer
- IP65 water-resistant



Firmware and PC Software

- Free Basic software for configuration, Historical viewer
- Extensive Software- Data Acquisition Software for configuration, Historical viewer and Real time viewer
- View Circular Trends in PR30
- Additional Panel Studio Software for editing and customizing displays
- Display values in Digital, Real time trends, Historical trends, Bar graphs etc.
- Real time and Historical alarms
- Event management, Jobs linked with events
- Reports (Daily, Weekly and Monthly)
- Timers, Counters, Totalizers, Math channels and optional FDA 21 CFR part 11
- Customized messages for alarms
- Alarms by email directly from paperless recorder
- Batch control, log data in batches
- 100 msec. data logging and historical data archival tools
- Display screen rotation
- Dynamic Data Exchange via PC software
- Search data with reference to time and period, then Export to spread sheets
- Data logging by value change or time base
- Start/Stop data logging functions which can be linked with real time clock or events

Historical Viewer in Free and Extensive Software:

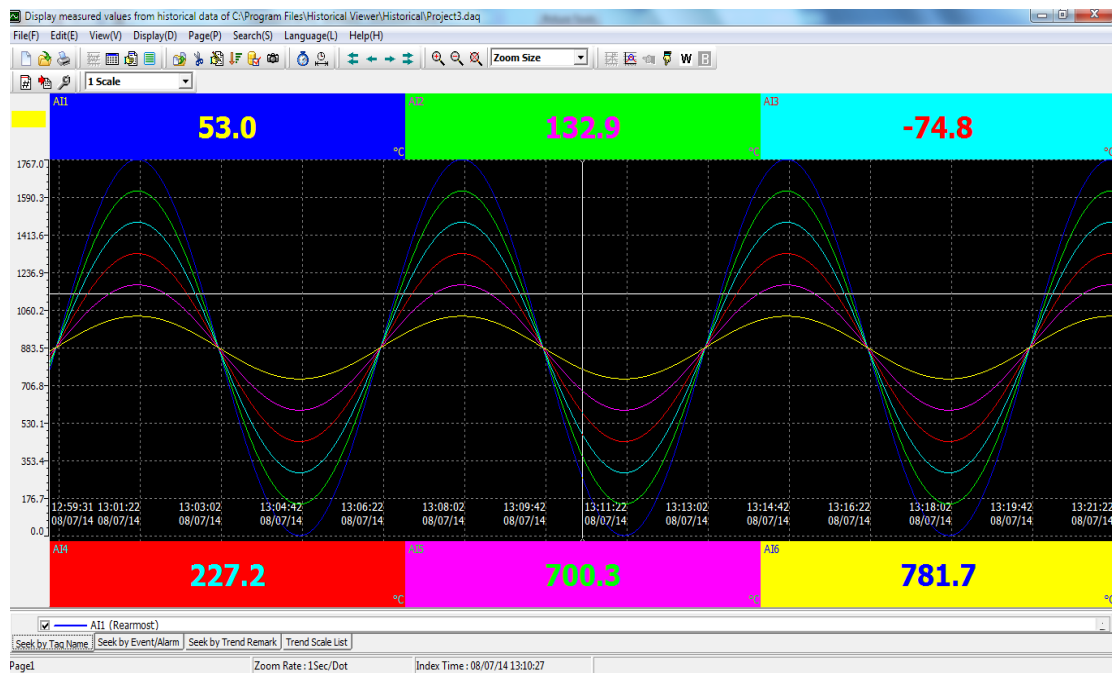

Configuration Editing in either Free or Extensive Software:

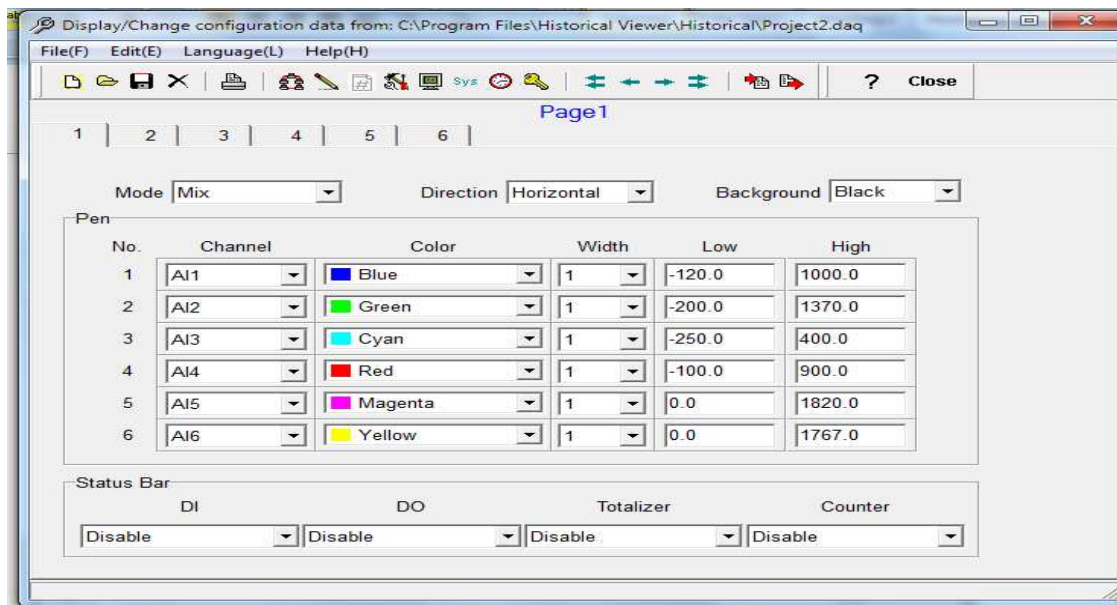

Extensive Software- Data Acquisition Studio with Real-time Viewer:

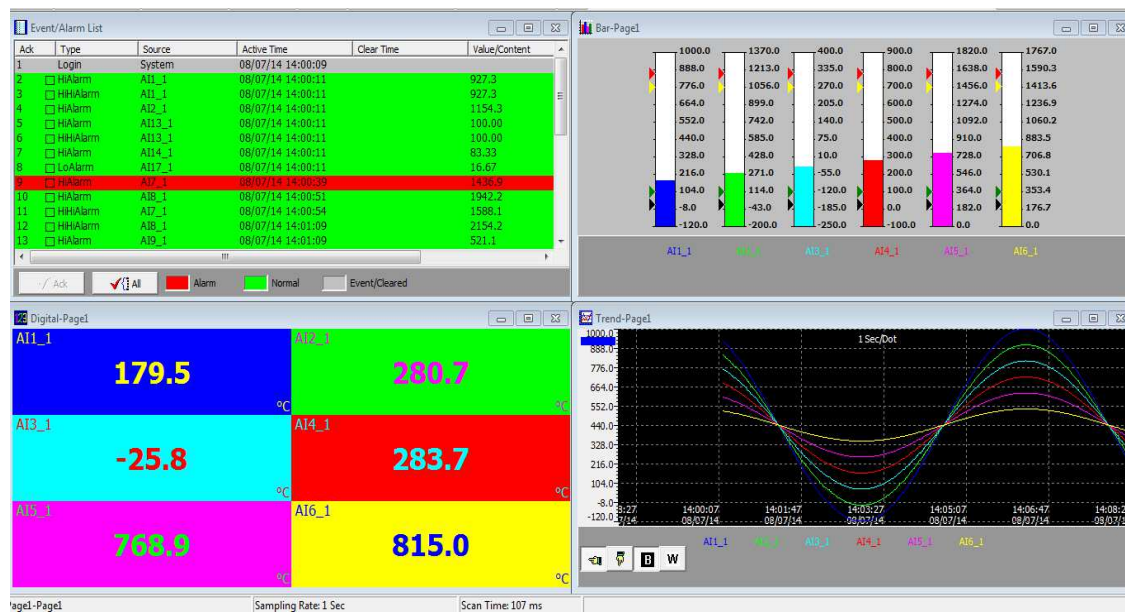

Panel Studio Software to Edit Custom Displays:

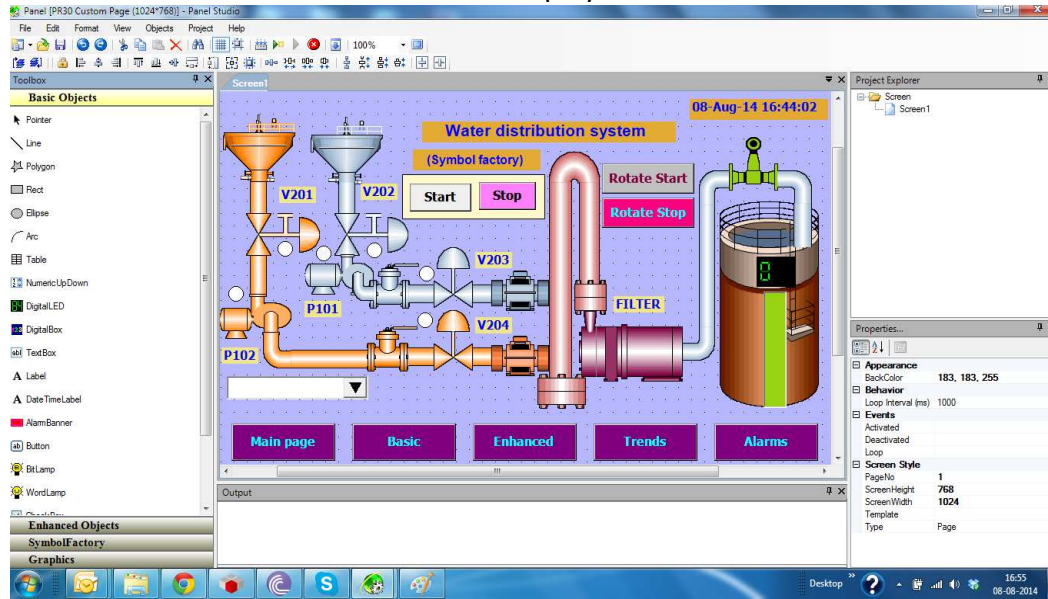

Circular Trends in PR30:

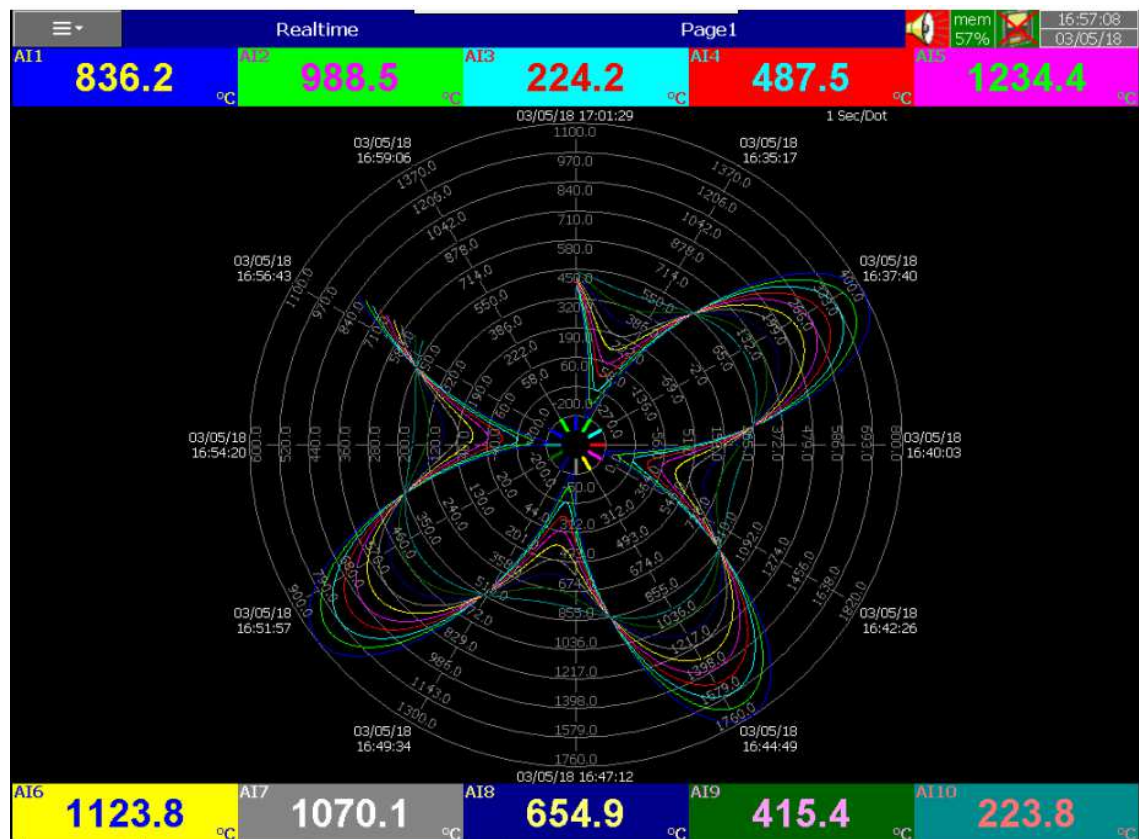

1.2 Comparison of PR series Recorders

Description	PR10	PR20	PR30
Display Size	4.3"	5.6"	12.1"
Analog Inputs (Maximum)	6	24	48
Math Channels (Maximum)	15	40	60
External Channels (Other devices)	24	48	96
Total Pages	8	20	21
Pens/Page (Maximum)	6	6	10
Batches (Maximum)	1	1	1

1.3 Expandable Input and Output cards

The recorder is equipped with rear expansion slots, which work flexibly with the following plug & play I/O cards.

Analog Input cards (part number AI206 & AI203): These two cards are used for 3 or 6-channel analog inputs. Each input is isolated from each other to avoid noise and to ensure stable measurement.

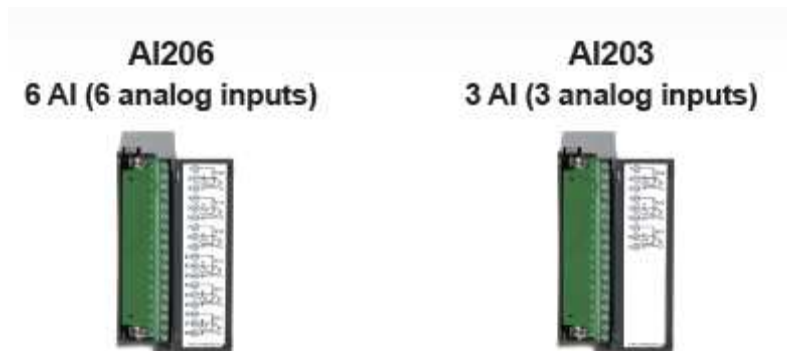

Relay Output card (RO206): Each card includes 6 alarm relays. Contacts are rated 5 Amp/240 VAC

RO206
6 relay outputs



Digital Input card (DI206): Each card includes 6 channels. Logic Low: -5V minimum, 0.8V maximum, Logic High: 3.5V minimum, 24V maximum

DI206
6 DI (6 digital inputs)



Combination Relay Output and Digital Input Card (RD233): Each Card includes 3 digital Inputs and 3 Relay Outputs. For Digital Inputs, Logic Low: -5V minimum, 0.8V maximum, Logic High: -3.5V minimum, 24V maximum. For Relay Outputs, the Contacts are rated 5 Amp/240 VAC

RD233
3 relays + 3DI



Analog Output cards (AO206): Each card includes 6 channels. They are used for 4-20mA, 0-20mA current output, 0-5V, 1-5V, 0-10VDC voltage output.

AO206
6 AO (6 analog outputs)



Process Control card (PC201): Each card includes 2 Analog channels and 5 Digital Channels (1-Digital input, 2-Digital outputs, 2-Digital Outputs for Alarms).

PC201
single loop process control



1.4 Communication

The standard communication interface is Ethernet with protocol IEEE 802.3 – 10/100 Base T. Other options are RS-232 / RS-422 / RS-485.

Details are explained in Chapter 2.6 - RS-232, RS-422, RS-485 wiring

1.5 External Storage media

There are two types of External storage for the recorder, SD card and USB. If the recorder is used with **6-channel inputs**, we've made an easy chart to show the maximum days based on available memory.

Log speed	SD card	16GB	32GB
1 second		15, 808 days	31,616 days
10 seconds		158,032 days	316,064 days
120 seconds		1,896,304 days	3,792,608 days

* The above is an approximation, each record of data uses 2 or 4 bytes of memory depending on the data type.

For ex: Selected data size = 2 bytes

If the Log Speed (the recording speed of measured data) is set to the fastest speed at 1 second per data, then for a six channels, a 16GB SD Card will last approximately 15,808 days [16GB / (2 bytes x 24 hours x 60 minutes x 60 seconds x 6 Channels)].

The following formula is to calculate how many days a USB disk can do saving before it is full.

$$\text{\# of days} = (\text{The capacity of SD card memory} \times \text{Log Speed}) / (2 \times \text{\# of hours per day} \times 60 \times 60 \times \text{Number of channels})$$

If the User is using USB to store data, to avoid losing recorded data while transferring to PC, it is necessary to insert USB memory back again into the recorder soon after loading recorded data onto PC. Otherwise, data may not be recorded while the USB is absent.

1.6 Smart Mechanism

The recorded data is stored in the manufacturer's special binary format. It is not possible to manipulate or modify the recorded data. This feature fully guarantees the security of the data.

Front View:



Rear View:

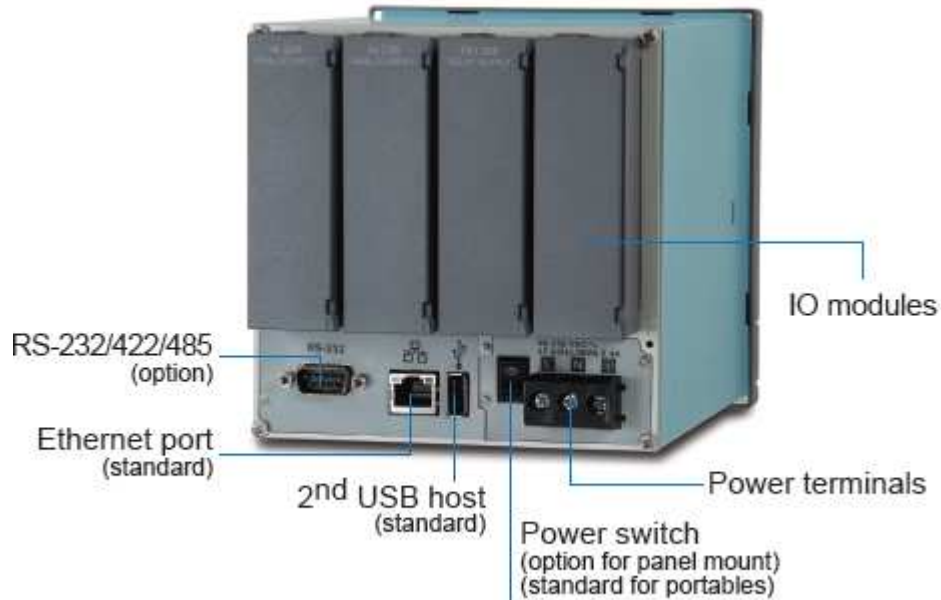

1.7 Ordering codes and accessories

1.7.1 PR10 Ordering code

PR1003 (3 Analog Inputs) –

--	--	--	--	--	--	--	--

1 2 3 4 5 6 7 8

1 Additional Inputs and Outputs*

- 0: none
- 6: 3 relays + 3 DI

PR1006 (6 Analog Inputs)

1 Additional Inputs and Outputs

- 0: none
- 1: 6 relays
- 3: 6DI
- 6: 3 relays + 3 DI
- 7: 6 relays + 6 DI

2 Power

- A: 90-250 VAC, 50/60 Hz
- D: 11-36 VDC

3 Communication

- 0: standard Ethernet interface
- 1: Ethernet + RS-232
- 2: Ethernet + RS-422/485

4 Firmware

- 0: Standard Version with Mathematic Functions
- 1: Plus Version 1 with external channels, batch & FDA 21 CFR part 11
- 2: Plus Version 2 with editable custom display and Panel Studio software
- 3: Plus Version 3- includes Plus Version 1+2 above

5 PC Software

- 1: Free Basic Software of Historical Viewer and Configuration
- 2: Extensive software Data Acquisition Studio
(Real Time Viewer + Historical Viewer + Configuration)

6 Mounting types, Power Cord & Switch

- 0: panel mount, no power cord, no power switch
- 1: panel mount, no power cord, power switch
- 2: portable, UL & CSA power cord, power switch
- 3: portable, VDE power cord, power switch
- 4: portable, SAA power cord, power switch
- 5: portable, BS power cord, power switch
- 6: portable, no power cord, power switch
- 7: Panel mount, UL & CSA power cord, power switch
- 8: Panel mount, VDE power cord, power switch
- 9: Panel mount, SAA power cord, power switch
- A: Panel mount, BS power cord, power switch

7 & 8 Special options

- 00: none
- S1: 16G SD card
- S2: 32G SD card
- 10: Process control card
- 11: Process control card + 16G SD card
- 10: Process control card + 32G SD card

*DI- Digital Input

1.7.2 PR20 Ordering code

PR2003 (3 Analog Inputs) –

1	2	3	4	5	6	7	8

1 Other Inputs and Outputs*

- 0: none
- 6: 3 relays + 3 DI
- C: 3 relays + 3 DI + 6 AO

PR2006 (6 Analog Inputs)

1 Other Inputs and Outputs*

- 0: none
- 1: 6 Relays
- 3: 6 DI
- 5: 6 AO
- 6: 3 relays + 3 DI
- 7: 6 relays + 6 DI
- A: 6 relays + 6 AO
- B: 6 DI + 6 AO
- C: 3 relays + 3 DI + 6 AO
- D: 6 relays + 6 DI + 6 AO

PR2012 (12 Analog Inputs)

1 Other Inputs and Outputs*

- 0: none
- 1: 6 Relays
- 2: 12 Relays
- 3: 6 DI
- 4: 12 DI
- 5: 6 AO
- 6: 3 relays + 3 DI
- 7: 6 relays + 6 DI
- 8: 9 relays + 3 DI
- 9: 3 relays + 9 DI
- A: 6 relays + 6 AO
- B: 6 DI + 6 AO
- C: 3 relays + 3 DI + 6 AO

PR2018 (18 Analog Inputs)

1 Other Inputs and Outputs*

- 0: none
- 1: 6 Relays
- 3: 6 DI
- 5: 6 AO
- 6: 3 relays + 3 DI

PR2024 (24 Analog Inputs)

1 Other Inputs and Outputs*

- 0: none

2 Power

- A: 90-250 VAC, 50/60 Hz
- D: 11-36 VDC

3 Communication

- 0: standard Ethernet interface
- 1: Ethernet + RS-232
- 2: Ethernet + RS-422/485

4 Firmware

- 0: Standard Version with Mathematic Functions
- 1: Plus Version 1 with external channels, batch & FDA 21 CFR Part 11
- 2: Plus Version 2 with editable custom display and Panel Studio software
- 3: Plus Version 3- includes Plus Version 1 and 2

5 PC Software

- 1: Free Basic Software of Historical Viewer and Configuration
- 2: Extensive software Data Acquisition Studio
(Real Time Viewer + Historical Viewer + Configuration)

6 Mounting types, Power Cord & Switch

- 0: panel mount, no power cord, no power switch
- 1: panel mount, no power cord, power switch
- 2: portable, UL & CSA power cord, power switch
- 3: portable, VDE power cord, power switch
- 4: portable, SAA power cord, power switch
- 5: portable, BS power cord, power switch
- 6: portable, no power cord, power switch
- 7: Panel mount, UL & CSA power cord, power switch
- 8: Panel mount, VDE power cord, power switch
- 9: Panel mount, SAA power cord, power switch
- A: Panel mount, BS power cord, power switch

7&8 Special options

00: none

S1: 16G SD card

S2: 32G SD card

10: Process control card

11: Process control card + 16G SD card

10: Process control card + 32G SD card

*DI- Digital Input

AO-Analog Retransmission Output

Note:

Process control card can not be chosen together with

5: 6AO,

A: 6 relays + 6AO

B: 6DI +6AO

C: 3 relays + 3DI + 6AO

D: 6 relays + 6DI + 6AO

nor with 24 analog inputs

1.7.3 PR30 Ordering code

PR3006 (6 Analog Inputs)	-	<table border="1"><tr><td></td><td></td><td></td><td></td><td></td><td></td><td></td><td></td><td></td><td></td></tr></table>										
PR3012 (12 Analog Inputs)		1										
PR3018 (18 Analog Inputs)		2										
PR3024 (24 Analog Inputs)		3										
PR3030 (30 Analog Inputs)		4										
PR3036 (36 Analog Inputs)		5										
PR3042 (42 Analog Inputs)		6										
PR3048 (48 Analog Inputs)		7										
		8										
		9										
		10										

1 Relay Outputs

- 0: none
- 1: 6 Relays
- 2: 12 Relays
- 3: 18 Relays
- 4: 24 Relays

2 Digital Inputs

- 0: none
- 1: 6 Channels
- 2: 12 Channels
- 3: 18 Channels

3 Analog Outputs

- 0: none
- 1: 6 Channels
- 2: 12 Channels

4 Power

- A: 90-250 VAC, 50/60 Hz
- D: 11-36 VDC

5 Communication

- 0: standard Ethernet interface
- 1: Ethernet + RS-232
- 2: Ethernet + RS-422/485

6 Firmware

- 0: Standard Version with Mathematic Functions
- 1: Plus Version 1 with external channels, batch & FDA21 CFR Part 11
- 2: Plus Version 2 with editable custom display and Panel Studio software
- 3: Plus Version 3- includes Plus Version 1 and 2

7 PC Software

- 1: Free Basic Software of Historical Viewer and Configuration
- 2: Extensive software Data Acquisition Studio
(Real Time Viewer + Historical Viewer + Configuration)

8 Mounting types, Power Cord & Switch

- 0: panel mount, no power cord, no power switch
- 1: panel mount, no power cord, power switch
- 2: portable, UL & CSA power cord, power switch
- 3: portable, VDE power cord, power switch
- 4: portable, SAA power cord, power switch
- 5: portable, BS power cord, power switch
- 6: portable, no power cord, power switch
- 7: Panel mount, UL & CSA power cord, power switch
- 8: Panel mount, VDE power cord, power switch
- 9: Panel mount, SAA power cord, power switch
- A: Panel mount, BS power cord, power switch

9&10 Special options

- 00: none
- S1: 16G SD card
- S2: 32G SD card
- 10: Process control card
- 11: Process control card + 16G SD card
- 10: Process control card + 32G SD card

Note:

PR30 can not use with process control card

1.7.4 PC201 Ordering code

PC201-

--	--	--	--

A B C D

A: Output 1

- 0: None
- 1: Relay 2A/240VAC
- 2: Pulse voltage to drive SSR, 5V/30mA
- 3: Isolated 4-20mA/0-20mA (OM95-3)
- 4: Isolated 1-5V/0-5V (OM95-4)
- 5: Isolated 0-10V (OM95-5)
- 6: Triac output 1A/240VAC, SSR
- C: Pulse voltage to drive SSR, 14V/40mA (OM94-7)

B: Output 2

- 0: None
- 1: Relay 2A/240VAC
- 2: Pulse voltage to drive SSR, 5V/30mA
- 3: Isolated 4-20mA/0-20mA (OM95-3)
- 4: Isolated 1-5V/0-5V (OM95-4)
- 5: Isolated 0-10V (OM95-5)
- 6: Triac output 1A/240VAC, SSR
- 7: Isolated 20VDC/25mA power supply (DC94-1)
- 8: Isolated 12VDC/40mA power supply (DC94-2)
- 9: Isolated 5VDC/80mA power supply (DC94-3)
- C: Pulse voltage to drive SSR, 14V/40mA (OM94-7)

C: Alarm 1

- 0: None
- 1: Form C relay 2A/240VAC

D: Alarm 2

- 0: None
- 1: Form A relay 2A/240VAC

1.7.5 Accessories:

Part no.	Descriptions
AI203	3-channel analog input card (TC, RTD, mA, V, mV)
AI206	6-channel analog input card (TC, RTD, mA, V, mV)
PC201	Process control card
RO206	6-channel relay output card
DI206	6-channel digital input card
RD233	3-channel Relay output and 3-channel digital input card
AO206	6-channel analog output card
IF232	RS-232 communication module for PR10 and PR20
IF485	RS-422/485 communication module for PR10 and PR20
IF232A	RS-232 communication module for PR30
IF485A	RS-422/485 communication module for PR30
PM201	90-250VAC 47-63Hz panel mount power supply board without power Switch for PR10 and PR20
PM202	90-250VAC 47-63Hz panel mount power supply board with power switch For PR10 and PR20
PM203	90-250VAC 47-63Hz portable power supply board with power switch for PR10 and PR20
PM211	11-36VDC panel mount power supply board without power switch for PR10 and PR20
PM212	11-36VDC panel mount power supply board with power switch for PR10 and PR20
PM213	11-36VDC portable power supply board with power switch for PR10 and PR20
PM301	90-250VAC 47-63Hz panel mount power supply board without power Switch for PR30
PM302	90-250VAC 47-63Hz panel mount power supply board with power switch For PR30
PM303	90-250VAC 47-63Hz portable power supply board with power switch for PR30
PM311	11-36VDC panel mount power supply board without power switch for PR30
PM312	11-36VDC panel mount power supply board with power switch for PR30
PM313	11-36VDC portable power supply board with power switch for PR30

Notes:

- ◆ The rear Slots of the recorder will only accept certain Input or output cards in any combination based on selected model.
- ◆ For example, PR10 has 4 empty slots. But only 3 slots can be used. In one slot, it needs 1 pc. Of either a 3 or 6 channel analog input card. The other slot can be used as per the combination showed in the ordering code.
- ◆ The basic PC software is supplied free with the recorder. There is an additional charge for the extensive Data Acquisition Software supplied with communication of RS-232/422/485 or Ethernet.
- ◆ The Ordering Code for various standard model Recorders with an AC supply and without any additional options are as follows:

PR1003- 0A001000

PR2003- 0A001000

PR3006- 000A001000

1.8 Specifications

Power:

90-250VAC, 47-63Hz, 52VA, 26W maximum

11-36VDC, 26VA, 26W maximum

PR30:

90-250VAC, 47-63Hz, 110VA, 62W maximum

11-36VDC, 62VA, 62W maximum

Display:

PR10: LCD, 480 x 272 pixel resolution, 65K color

PR20: LCD, 640 x 480 pixel resolution, 65K color

PR30: LCD, 1024 x 768 pixel resolution, 65K color

Memory:

256MB storage memory on board

Process Control Card (PC201):

Please refer **UMPRPID01** manual, Chapter 1.7, for the details

Analog Input Cards (AI20X):

Channels: AI203 ~ 3 channels, AI206 ~ 6 channels

Resolution: 24 bits

Sampling Rate: 10 times/ second

Maximum Rating: RTD input $\pm 20V$

T/C and Voltage input $\pm 65V$

mA input $\pm 10V$

Temperature Effect: $\pm 0.1\mu V \pm 15PPM$ of reading for all inputs except mA, $\pm 30PPM$ of reading for mA input

Sensor Lead Resistance Effect: T/C: 0.32PPM of reading/ohm, 3-wire RTD: 2.6°C/ohm of resistance difference of two leads (Based on °C measurement temperature for PT100)

2-wire RTD: 2.6°C/ohm of resistance sum of two leads (Based on °C measurement temperature for PT100)

Burn-out Current: 10 μA

Common Mode Rejection Ratio (CMRR): 120dB

Normal Mode Rejection Ratio (NMRR): 55dB

Isolation Breakdown Voltage between channels: 1500VAC min.

Sensor Break Detection:

Sensor opened for TC, RTD and mV inputs, below 1 mA for 4-20mA input, below 0.25V for 1-5V inputs, unavailable for other inputs

Sensor Break Responding Time: Within 1 seconds for TC, RTD and mV inputs, 0.1 second for 4-20 mA and 1-5V inputs

Characteristics:

Type	Range	Accuracy at 25 °C	Input Impedance
J	-120 ~ 1000 °C (-184 ~ 1832 °F)	±1 °C	3.12MΩ
K	-200 ~ 1370 °C (-328 ~ 2498 °F)	±1 °C	3.12MΩ
T	-250 ~ 400 °C (-418 ~ 752 °F)	±1 °C	3.12MΩ
E	-100 ~ 900 °C (-148 ~ 1652 °F)	±1 °C	3.12MΩ
B	0 ~ 1820 °C (32 ~ 3308 °F)	±2 °C (200 ~ 1820 °C)	3.12MΩ
R	0 ~ 1768 °C (32 ~ 3214 °F)	±2 °C	3.12MΩ
S	0 ~ 1768 °C (32 ~ 3214 °F)	±2 °C	3.12MΩ
N	-250 ~ 1300 °C (-418 ~ 2372 °F)	±1 °C	3.12MΩ
L	-200 ~ 900 °C (-328 ~ 1652 °F)	±1 °C	3.12MΩ
U	-200 ~ 600 °C (-328 ~ 1112 °F)	±1 °C	3.12MΩ
P	0 ~ 1395 °C (32~2543 °F)	±1 °C	3.12MΩ
W5 or C	0 ~ 2315 °C (32 ~ 4199 °F)	±1 °C	3.12MΩ
W3	0 ~ 2315 °C (32 ~ 4199 °F)	±1 °C	3.12MΩ
LR	-200 ~ 800 °C (-328 ~ 1472 °F)	±1 °C	3.12MΩ
A1	0 ~ 2500 °C (-32 ~ 4532 °F)	±1 °C	3.12MΩ
A2	0 ~ 1800 °C (-32 ~ 3272 °F)	±1 °C	3.12MΩ
A3	0 ~ 1800 °C (-32 ~ 3272 °F)	±1 °C	3.12MΩ
M	-200 ~ 100 °C (-328 ~ 212 °F)	±1 °C	3.12MΩ
PT50 (α = 0.00385)	-200 ~ 850 °C (-328 ~ 1562 °F)	±0.4 °C	2.0KΩ
PT100 (α = 0.00385)	-200 ~ 850 °C (-328 ~ 1562 °F)	±0.4 °C	2.0KΩ
PT200 (α = 0.00385)	-200 ~ 850 °C (-328 ~ 1562 °F)	±0.4 °C	2.0KΩ
PT500 (α = 0.00385)	-200 ~ 850 °C (-328 ~ 1562 °F)	±0.4 °C	2.0KΩ
PT1000 (α = 0.00385)	-200 ~ 350 °C (-328 ~ 662 °F)	±0.4 °C	2.0KΩ

PT50 ($\alpha = 0.00391$)	-200 ~ 850 °C (-328 ~ 1562 °F)	± 0.4 °C	2.0K Ω
PT100 ($\alpha = 0.00391$)	-200 ~ 850 °C (-328 ~ 1562 °F)	± 0.4 °C	2.0K Ω
JPT50 ($\alpha = 0.003916$)	-200 ~ 600 °C (-328 ~ 1112 °F)	± 0.4 °C	2.0K Ω
JPT100 ($\alpha = 0.003916$)	-200 ~ 600 °C (-328 ~ 1112 °F)	± 0.4 °C	2.0K Ω
JPT200 ($\alpha = 0.003916$)	-200 ~ 600 °C (-328 ~ 1112 °F)	± 0.4 °C	2.0K Ω
JPT500 ($\alpha = 0.003916$)	-200 ~ 600 °C (-328 ~ 1112 °F)	± 0.4 °C	2.0K Ω
JPT1000 ($\alpha = 0.003916$)	-200 ~ 350 °C (-328 ~ 662 °F)	± 0.4 °C	2.0K Ω
Cu50 ($\alpha = 0.00426$)	-50 ~ 200 °C (-58 ~ 392 °F)	± 0.4 °C	2.0K Ω
Cu100 ($\alpha = 0.00426$)	-50 ~ 200 °C (-58 ~ 392 °F)	± 0.4 °C	2.0K Ω
Cu50 ($\alpha = 0.00428$)	-180 ~ 200 °C (-292 ~ 392 °F)	± 0.4 °C	2.0K Ω
Cu100 ($\alpha = 0.00428$)	-180 ~ 200 °C (-292 ~ 392 °F)	± 0.4 °C	2.0K Ω
Ni100 ($\alpha = 0.00617$)	-60 ~ 180 °C (-76 ~ 356 °F)	± 0.4 °C	2.0K Ω
Ni200 ($\alpha = 0.00617$)	-60 ~ 180 °C (-76 ~ 356 °F)	± 0.4 °C	2.0K Ω
Ni500 ($\alpha = 0.00617$)	-60 ~ 180 °C (-76 ~ 356 °F)	± 0.4 °C	2.0K Ω
Ni1000 ($\alpha = 0.00617$)	-60 ~ 180 °C (-76 ~ 356 °F)	± 0.4 °C	2.0K Ω
Cu10 ($\alpha = 0.00427$)	-200 ~ 260 °C (-328 ~ 500 °F)	± 0.1 °C	2.0K Ω
$\pm 20\text{mA}$	-26 ~ 26mA	$\pm 0.05\%$	75 Ω
$\pm 60\text{mV}$	-122 ~ 122mV	$\pm 0.05\%$	3.12M Ω
$\pm 200\text{mV}$	-243 ~ 243mV	$\pm 0.05\%$	3.12M Ω
$\pm 1\text{V}$	-1.58 ~ 1.58mV	$\pm 0.05\%$	3.12M Ω
$\pm 2\text{V}$	-3.16 ~ 3.16mV	$\pm 0.05\%$	3.12M Ω
$\pm 6\text{V}$	-6.32 ~ 6.32V	$\pm 0.05\%$	3.12M Ω
$\pm 20\text{V}$	-25.3 ~ 25.3V	$\pm 0.05\%$	3.12M Ω
$\pm 50\text{V}$	-50.6 ~ 50.6V	$\pm 0.05\%$	3.12M Ω
0.4 ~ 2V	-3.16 ~ 3.16V	$\pm 0.05\%$	3.12M Ω
1 ~ 5V	-6.32 ~ 6.32V	$\pm 0.05\%$	3.12M Ω

Digital Input Card (DI206):

Channels: 6 per card

Logic Low: -5V minimum, 0.8V maximum

Logic High: 3.5V minimum, 24V maximum

External pull-down Resistance: 1K Ω maximum

External pull-up Resistance: 1.5M Ω minimum

Relay Output Card (RO206):

Channels: 6 per card
Contact Form: N.O. & N.C. (form C)
Relay Rating: 5A/240 VAC, life cycles 200,000 for resistive load

Analog Output Card (AO206):

Channels: 6 per card
Output signal: 4-20mA, 0-20mA, 0-5V, 1-5V, 0-10V
Resolution: 16 bits
Accuracy: $\pm 0.05\%$ of Span $\pm 0.0025\%$ / $^{\circ}$ C
Load Resistance: 0-500 ohms (current), 10K ohms minimum (voltage)
Output Regulation: 0.01% for full load change
Output Setting Time: 0.1 second (stable to 99.9%)
Isolation Breakdown Voltage: 1500VAC at 50/60Hz for 1 minute
Integral Linearity Error: $\pm 0.005\%$ of Span
Temperature Effect: $\pm 0.0025\%$ of Span / $^{\circ}$ C

Note: there are DIP switches on the AO card and default is SET to Voltage output, For ma Output, SET 1 to 5 (ON), and 6 to 8 (OFF). More details refer to Chapter 4.1.4

COMM Module (IF232 and IF485):

Interface: RS-232 (1 unit), RS-485 or RS-422 (up to 247 units)
Protocol: Modbus Protocol RTU mode
Address: 1-247
Baud Rate: 9.6 ~ 115.2 Kbits/sec.
Measured data Bits: 7 or 8 bits
Parity Bit: None, Even or Odd
Stop Bit: 1 or 2 bits

Real-time Clock:

Item	Description
Make	Seiko Instruments
Model	MS621-FL11E
Rating	3V/4 mAH
Typical life time	10 yrs
Buffer period	6 months
Type	Rechargeable
Accuracy	Maximum +/- 2 sec/day

Standard Ethernet Communication:

Protocol: Modbus TCP/IP, 10/100 Base T

Ports: AUI (Attachment Unit Interface) and RJ-45, Auto- detect capability

Real time clock accuracy vs. temperature inside of housing

Temperature inside housing	typical error per month
10 ~ 40 °C	18 seconds
0 °C or 50 °C	52 seconds
-10°C or 60 °C	107 seconds

Environmental & Physical:

Operating Temperature: 0 ~ 50 °C

Storage Temperature: -30 ~ 70 °C

Humidity: 20 to 90% RH (non-condensing), maximum relative humidity 90% is for ambient temperature up to 38°C decreasing linearly to 50% relative humidity at 50°C

Altitude: 2000 M maximum

Insulation Resistance: 20 M ohms min. (at 500 VDC)

Dielectric Strength: 2300VAC, 50/60 Hz for 1 minute between power terminal and earth

Vibration Resistance: 10-55 Hz, 10m/ s² for 2 hours

Shock Resistance: 30m/ s² (3g) for operation, 20g for transportation

Operation Position: no inclined restriction

Dimensions: Panel Mount style: 144(W) x 144(H) x 193mm (D) (for PR10/20)
288(W) x 288(H) x 194mm (D) (for PR30)

Standard Panel Cutout: 137 x 137mm (for PR10/20)
281 x 281mm (for PR30)

Approval Standards:

Safety: UL 61010C-1, CSA C22.2 No. 61010-1-12

CE: EN61010-1 (IEC61010-1) over voltage category II, Pollution degree 2

**Note: PR30 CE & UL in process

Protective Class: IP 65 front panel for indoor use,
IP 20 housing and terminals

EMC:

Emission: EN61326-1 (EN55022 class A, EN61000-3-2, EN61000-3-3)

Immunity: EN61326-1 (EN61000-4-2, EN61000-4-3, EN61000-4-4,
EN61000-4-5, EN61000-4-6, EN61000-4-8, EN61000-4-11)

2. Installation and wiring

2.1 Unpacking

If any damage is found while unpacking, the user should contact the local representative at once. It is suggested that the special packaging is retained for possible future requirements.

2.2 Installation



Remove stains from this equipment using a soft, dry cloth. Do not use harsh chemicals, volatile solvents such as thinner or strong detergents to clean the equipment in order to avoid deformation.

The recorder is designed for indoor use and not in any hazardous area. It should be kept away from shock, vibration, and electromagnetic fields such as variable frequency drives, motors and transformers.

It is intended to operate under the following environmental conditions:

Pollution Degree Level II	IEC1010-1(EN61010-1)
Temperature	0 ~ 50 °C
Humidity	20 ~ 90 % RH (non-condensing)
Power	90 ~ 250 VAC, 50/60 Hz or 11-36VDC
Altitude	2000M maximum

2.3 Panel mounting style

PR10:

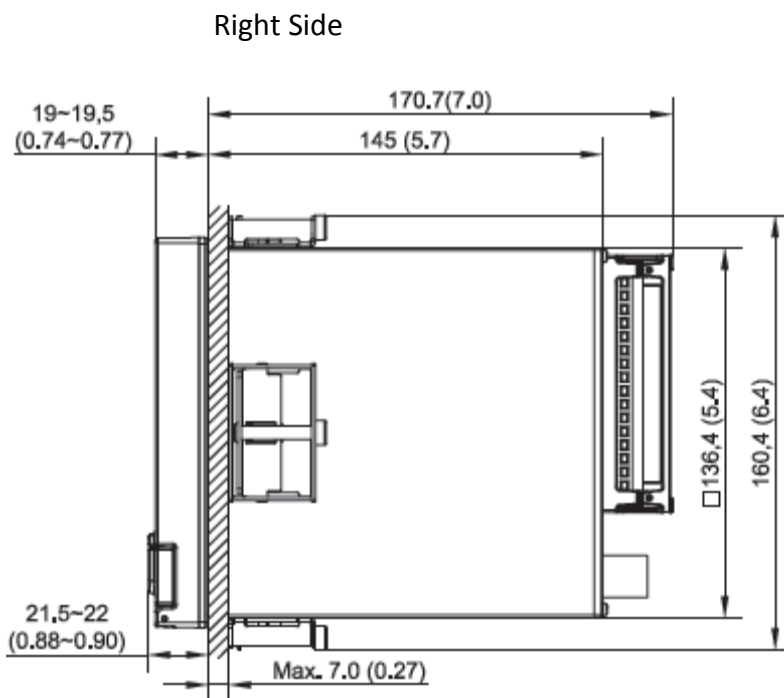
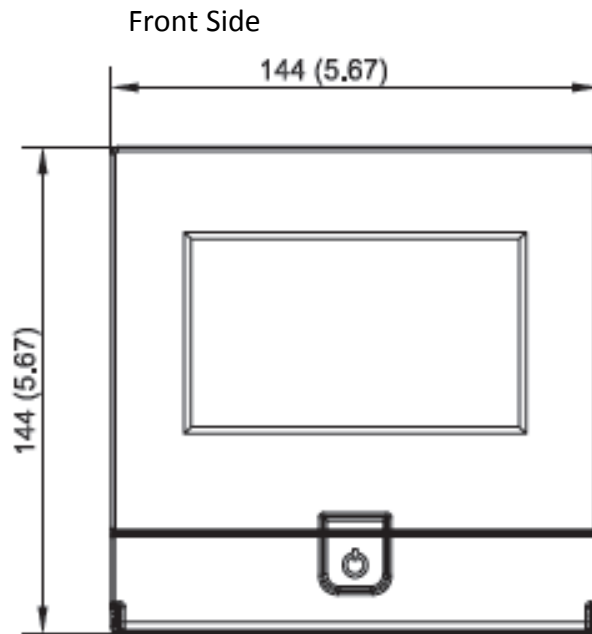

Panel Cut Out Dimensions

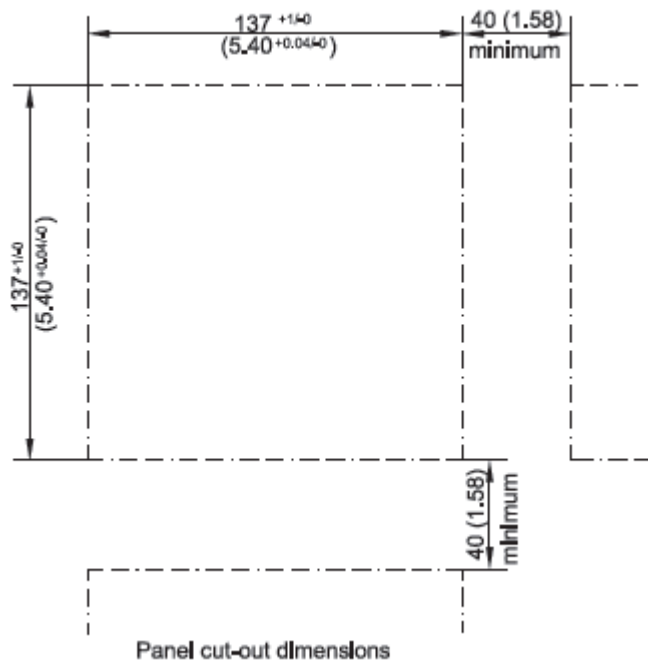

PR20:

Front Side

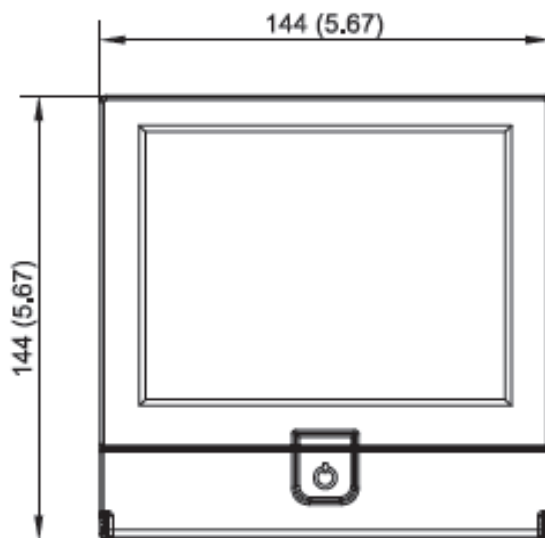

Right Side

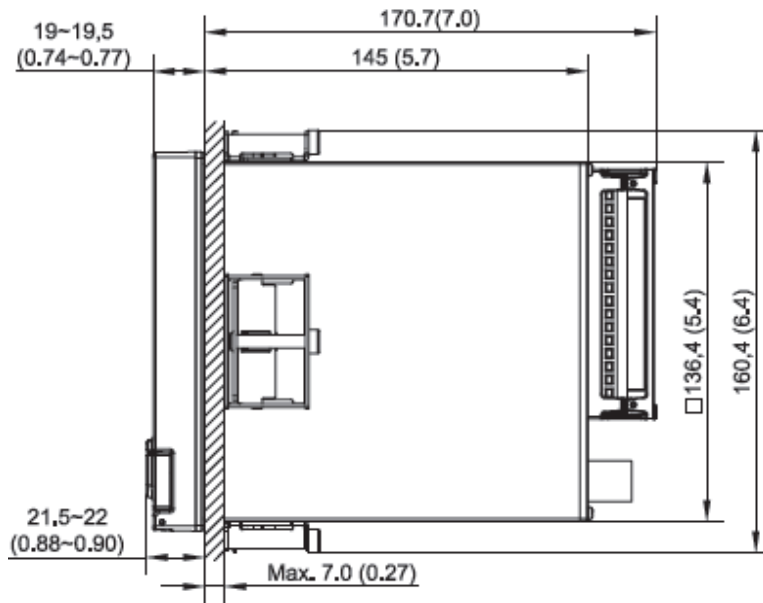

Panel Cut Out Dimensions

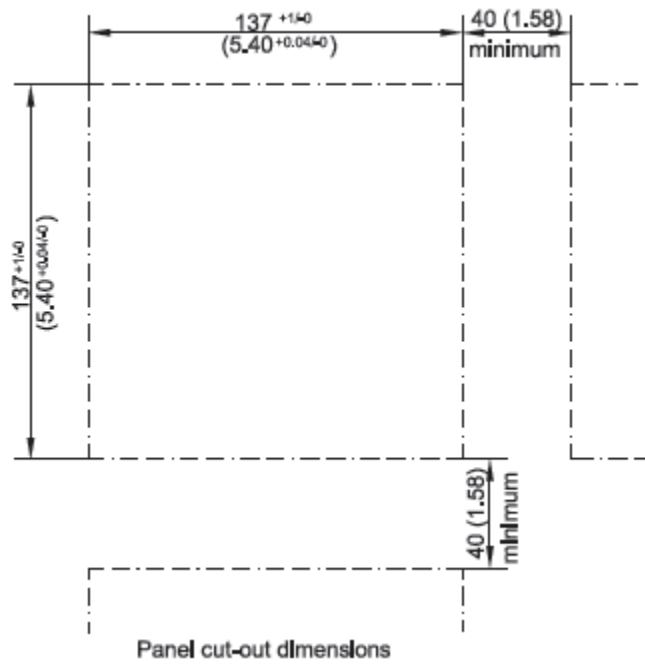

PR30:

Front Side

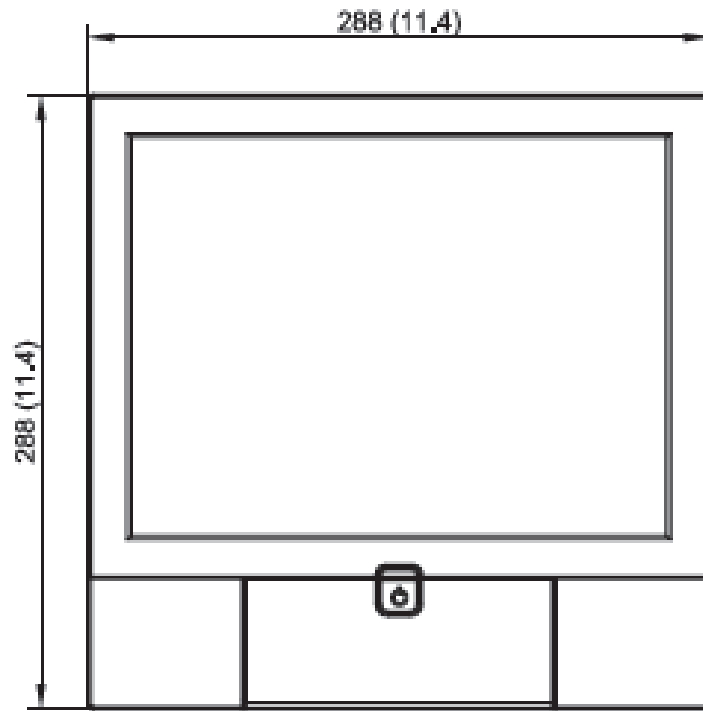

Right Side

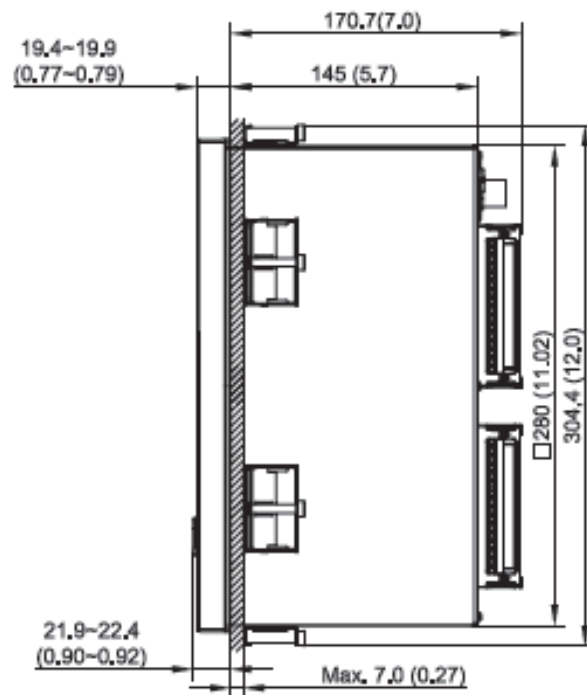

Panel Cut Out Dimensions

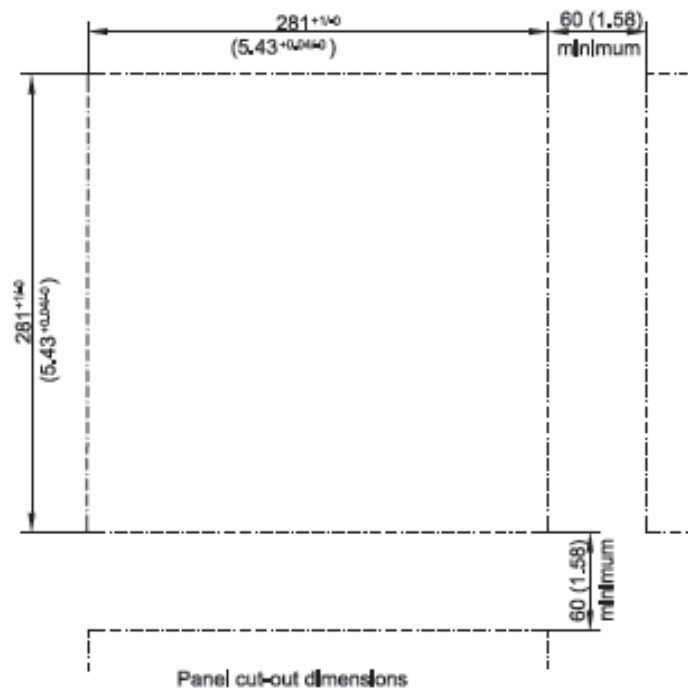

Note:

- ◆ Do not over tighten mounting clamp screws that could result in distortion of the case.
- ◆ There is no mounting angle restriction.
- ◆ The mounting torque used for 4 sides of the housing should be 2.0 KgF-cm and not more than 2.5 KgF-cm

Portable styles:

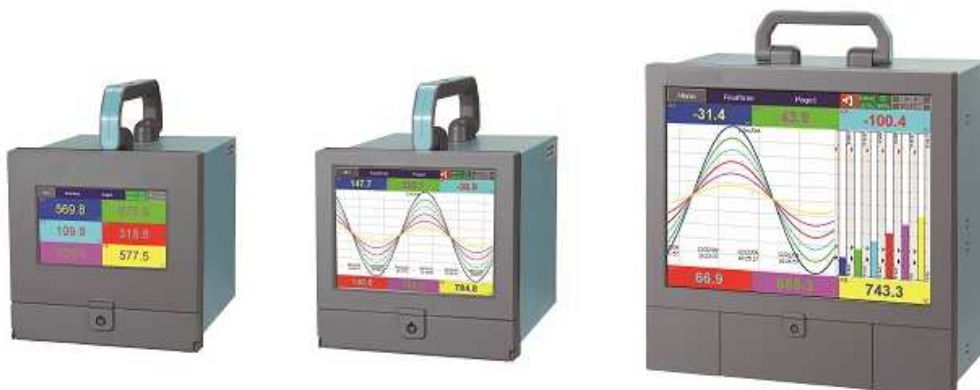

Bottom Side View of PR20 & PR10:

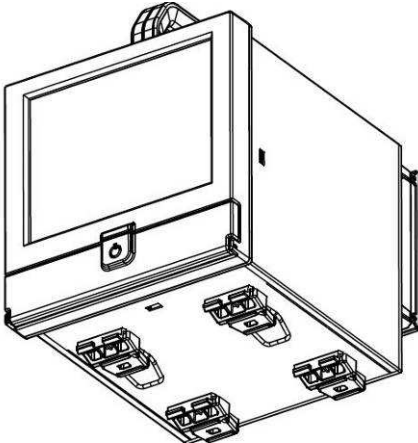

Front Side View of PR20 & PR10:

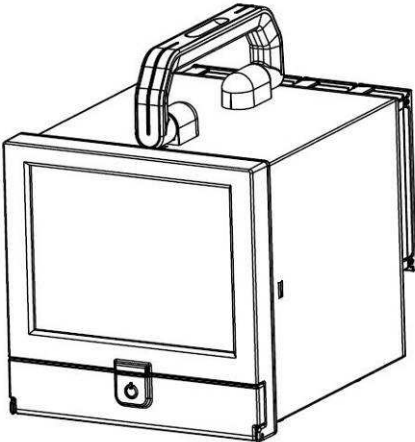

Bottom Side View of PR30

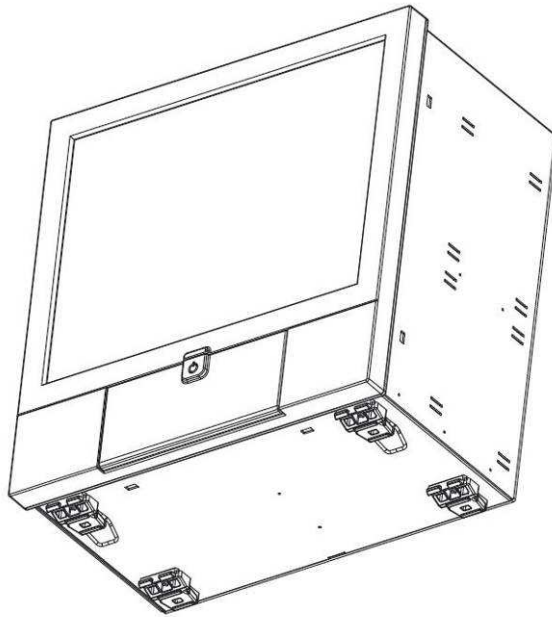

Front Side View of PR30:

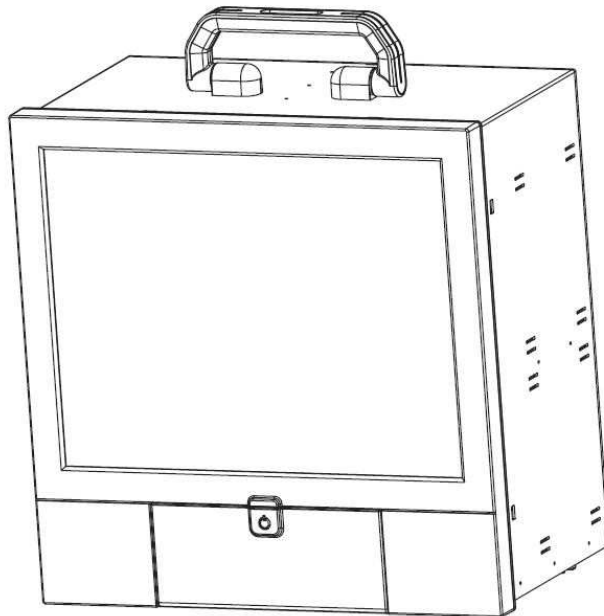

Bottom Stand Clips:

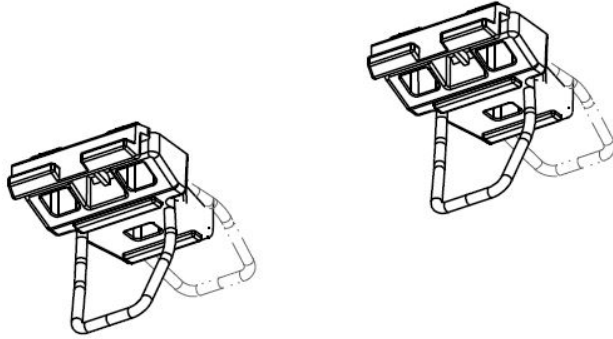

Top Holding Handle:

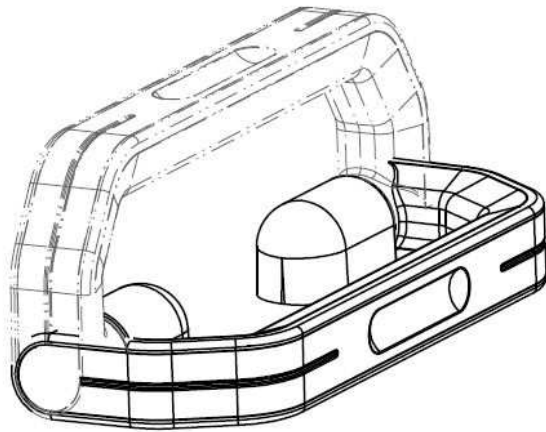

2.4 Setup input and output

Analog input cards (part numbers AI206 and AI203)

AI206 and AI203 are analog input cards in 3 and 6 channels respectively. Each card includes universal inputs of TC (J, K, T, E, B, R, S, N, L, U, P, W5, W3, LR, A1, A2, A3, and M), RTD, mV, mA, V. The accepted input types and sensor range for each type are listed in clause 1.8 of chapter 1. Plug the card into the rear slot then power on. The recorder will automatically detect the card and display the specific input type, then show its location in a specific slot when the user is in Configuration Mode.

To select a specific input, please press menu and then the Config button to get into the configuration window. In the configuration window, press up/down and enter key to select AI to get into AI setting window. In the AI setting window, move the selected focus to the item "Type" under the node "Sensor", then press the enter key to select the desired sensor type. Press OK when finished. All other items are similar to set up. The item "Events" can be added to do further control.

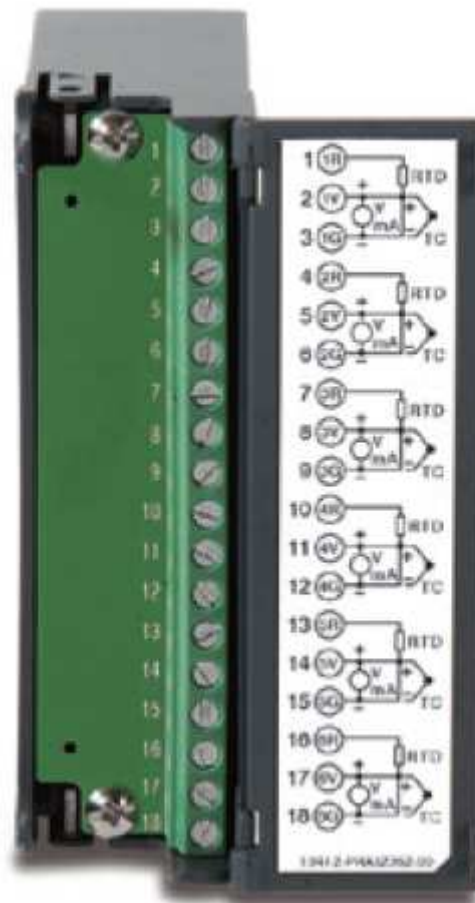

Figure 2 – 15 (AI206)

Relay Output card (RO206) / 6 relay alarm card

The relay output card includes 6 relays rated 5 Amp/240 VAC each. Plug the card into a rear slot and power on the recorder. The recorder will automatically detect the card and display the output type and its location in a specific slot in **System Info** mode while doing the configuration.

To set up the relay output card, please press **menu** and then the **Config** button to get into the configuration window. In the configuration window, press up/down and enter key to select DO and to get into the DO setting window. In the DO setting window, the setup steps are similar to AI. The item "Reverse" is to reverse the output status.



Digital Input card (DI206)

This card includes 6 channels of event inputs. As above, plug the card into rear slot and power on the recorder. The recorder will automatically detect it, and then display the input type and its location in a specific slot in **System Info** mode while doing the configuration.

To set up the digital input card, please press **menu** and then the **Config** button to get into the configuration window. In the configuration window, press up/down and enter key to select DI and get into the DI setting window. In the DI setting window, the setup steps are similar to AI. The item "Type" is for the user to decide if this channel will have a logic level or Pulse Counter input. If you select Pulse Counter, the item "Frequency" will appear for you to select input frequency (100Hz,). The item "Events" can be added to do further control.

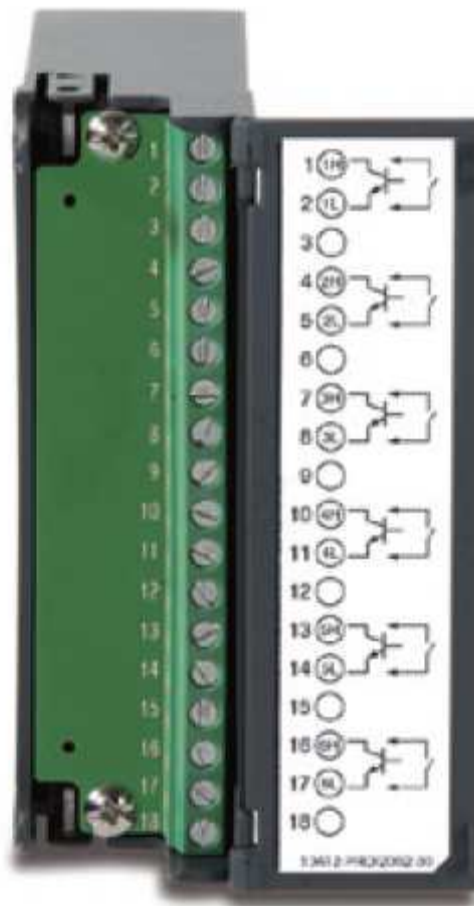

Combination Digital Input and Output card (RD233)

This card includes 3 relays rated 5 Amp/240VAC each and 3 Channels of Digital Inputs. As above, plug the card into rear slot and power on the recorder. The recorder will automatically detect it, and then display the input type and also a Relay. The first 3 combination are for relays (Terminal 1 to 9) and last 3 combination are for Digital inputs (Terminals 10 to 18). The setup is similar to relay output card and digital input card.

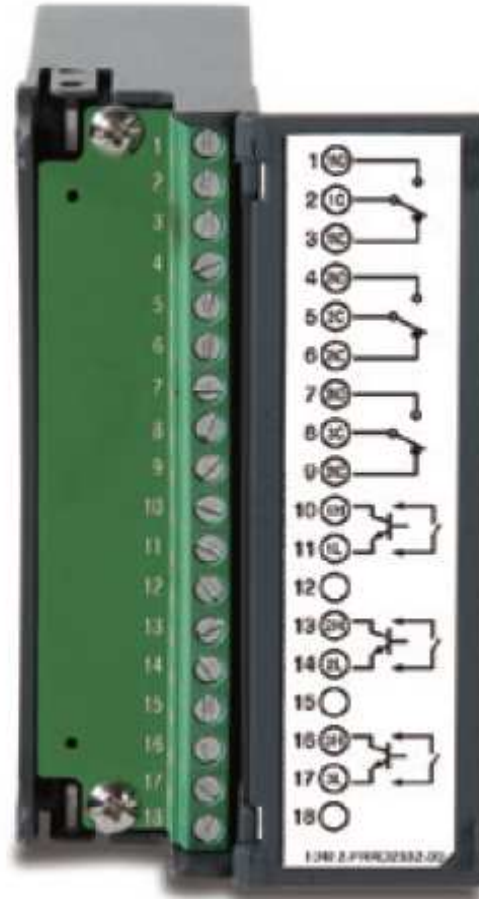

Analog output cards (AO206)

These cards are 6-channel current output cards. They are used to retransmit process values to other devices like meters, controllers, ect.

To set up the analog output card, please press the menu and then the Config button to get into the configuration window. In the configuration window, press the up/down and enter key to select AO. This will get you into the AO setting window. In the AO setting window, the setup steps are similar to AI. The item "Type" is to decide whether to output current or voltage. The item "Output" is to select the output range for current or voltage (0-10, 4-20mA, ect.). The item "Expression" is a math expression field where the user can input an expression to control the output value.

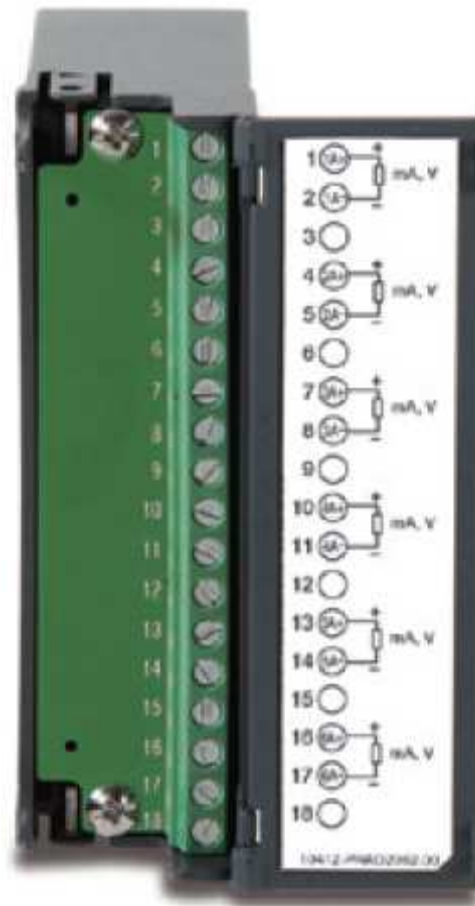

PID Control card (PC201)

Please refer manual UMPC201 for more information on the card.

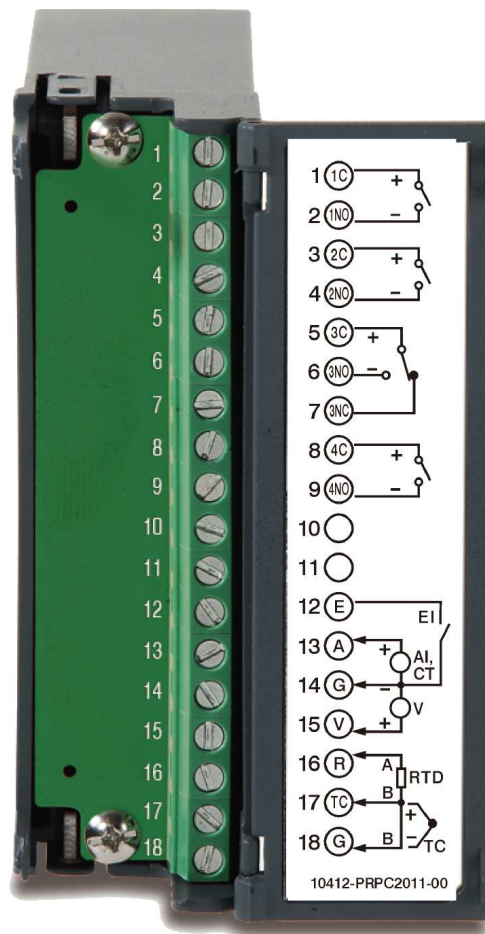

Note 1: The IO Cards should not be removed or Inserted to the PR when the Power is ON. This should be carried out in the Power OFF condition only.

Note 2: In the PR30, the Analog Input card should be inserted in slots 1 to 8 only. It should not be inserted in slots 9 to 16.

Note 3: The below pictures explain how to install a new AI card into a recorder slot:

Information regarding removing the IO Cards from PR.

For removing the IO Card, First remove the metal screws then plastic screws, after that press the lock on the top and bottom of the Card and pull to remove it. Failing to do so will damage the IO Card. Please follow the below pictures for more information.

The Maximum Torque for the metal screw is 3Kg-cm (2.6in-lb) and the Maximum Torque for the plastic screw is 0.8Kg-cm (.7in-lb).

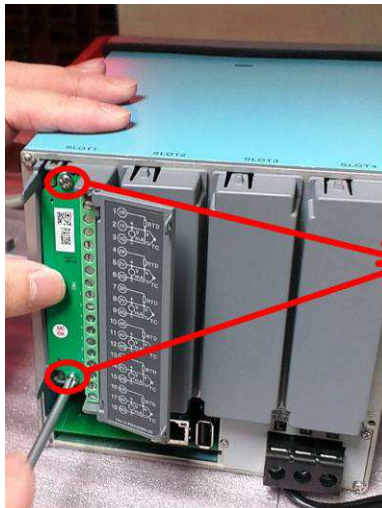

Metal
Screws

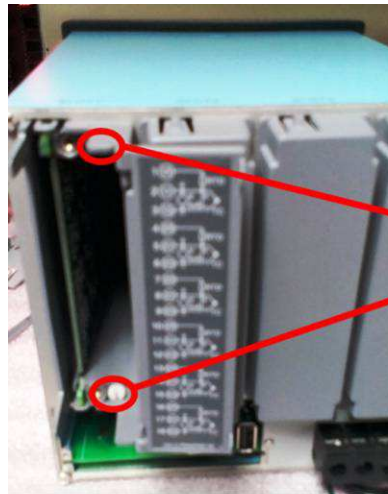

Plastic
screws



Note 4: For some industries who prefer/favour circular displays, PR30 can offer this unique feature and set the display speed for each page/circle in 30 minutes, 1, 2, 4, 8, 12 hours, 1, 2 days, or 1, 2, 4 weeks.

Note 5: Calibrate: Sometimes the field calibration is required for high accuracy. In this case, a qualified engineer can do the necessary calibration.

Note 6: For Thermocouple Inputs, a 1 hour warm up is necessary for initial set up.

Note 7: Circular Trends are only available for the PR30 mode.

2.5 Wiring of the cards



Wiring Precautions

1. Care must be taken to ensure that the maximum voltage rating specified on the label is not exceeded.
2. For the panel-mount version, it is recommended that near an external fuse or an external switch rated at 2A/250 VAC should be used.
3. Beware not to over tighten the terminals screws. The torque should not exceed 0.4 N-m (3.6 Lb-in or 4.0 Kg F-cm).
4. With the exception of the thermocouple wires, all wires should be stranded copper conductor with maximum gauge of 18 AWG.
5. Connect a grounding conductor with 1.6mm diameter minimum to provide protective grounding prior to turning on the equipment.

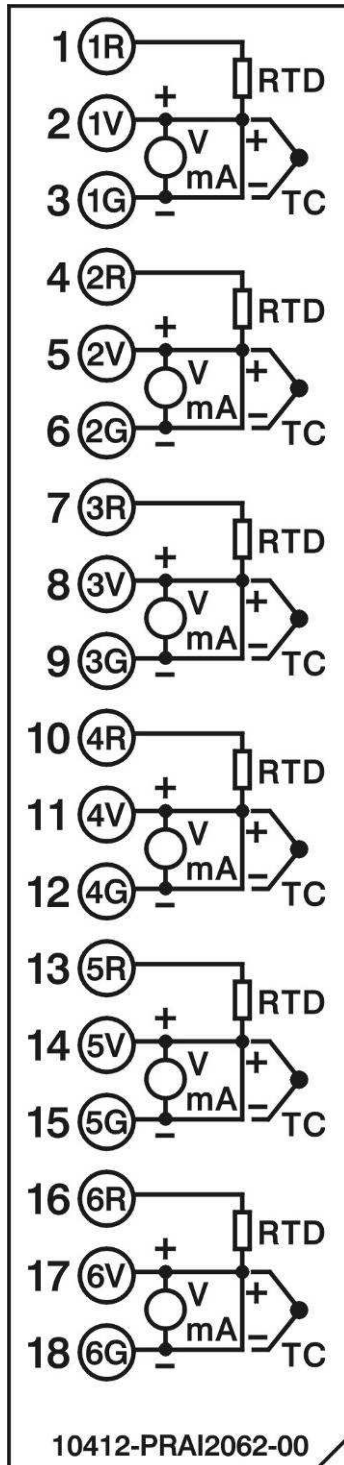

Analog Input Card AI206

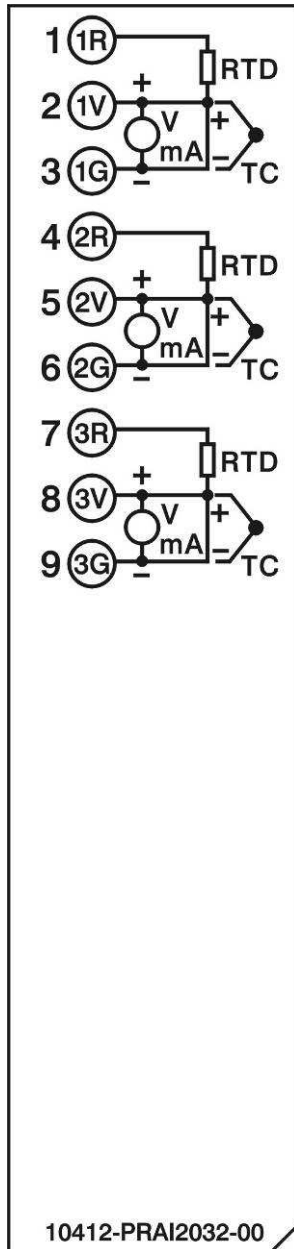

Analog Input Card AI203

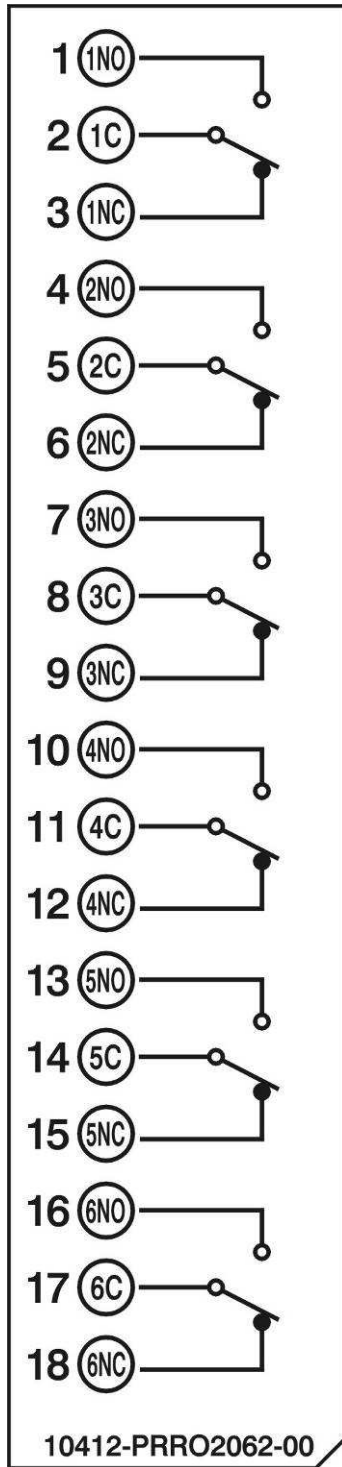

Relay output card (RO206)

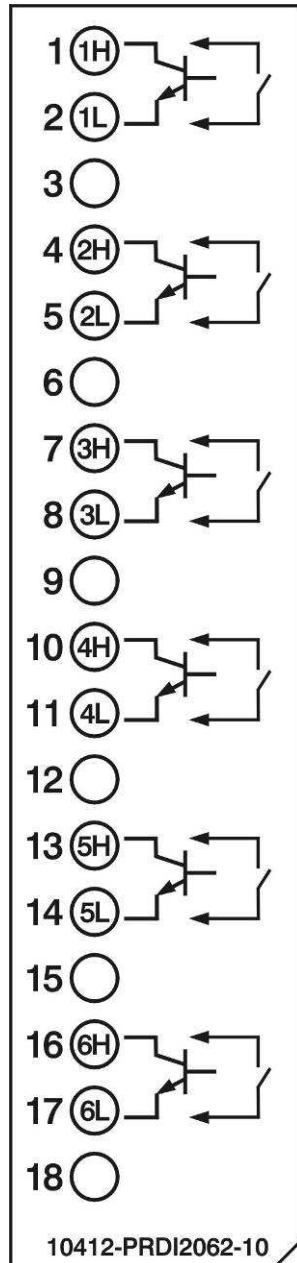

Digital input card (DI206)

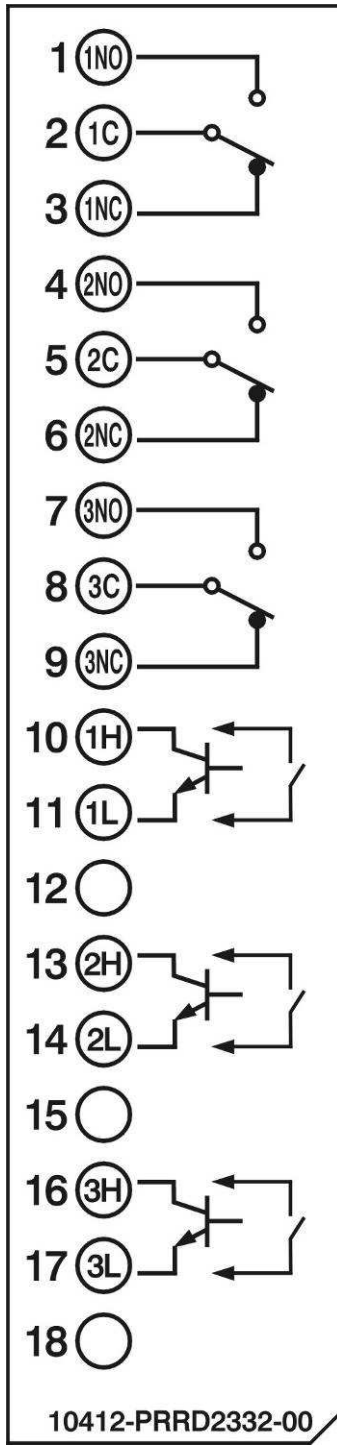

Relay output and digital input card (RD233)

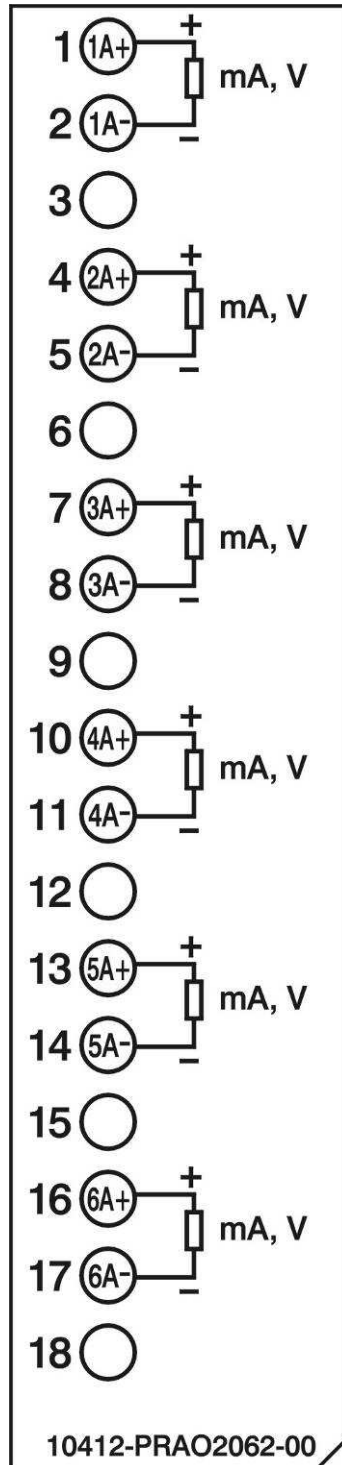

Analog output card (AO206)

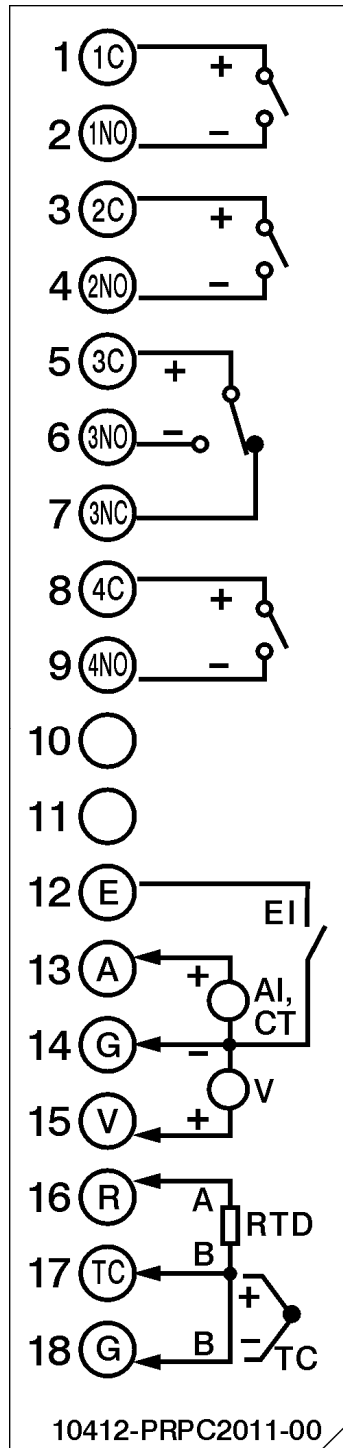

PID Control card (PC201)

2.6 RS-232, RS-422, and RS-485 wiring

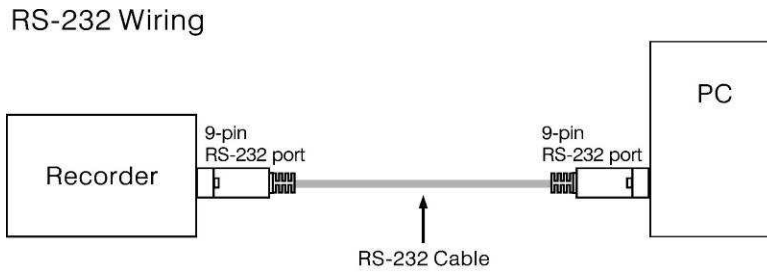

Configuration of The RS-232 Cable

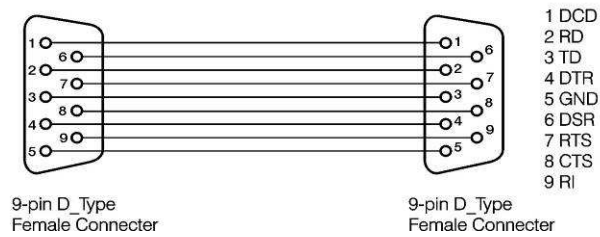
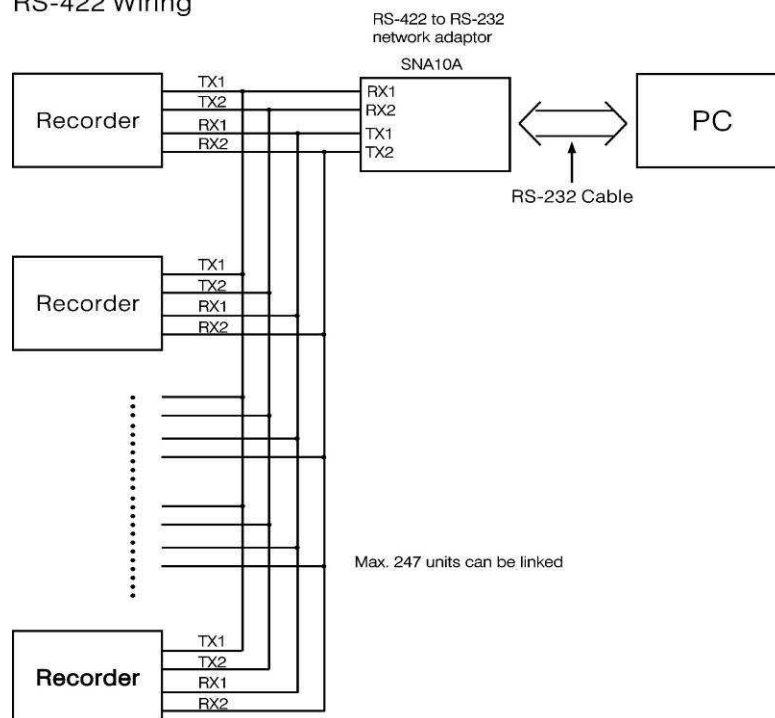
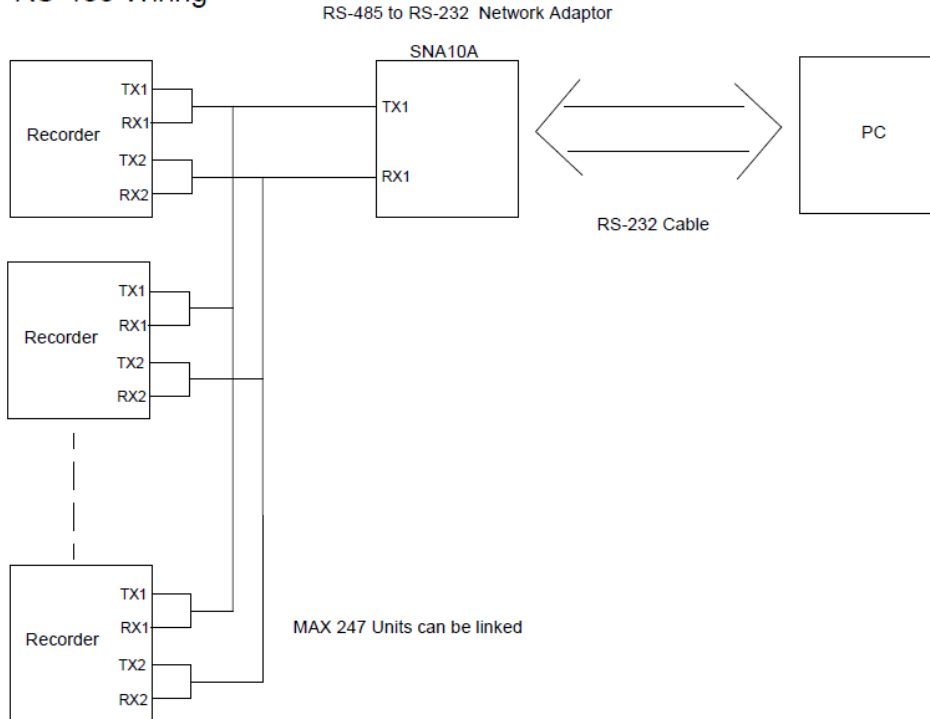

Figure 2 – 24

RS-422 Wiring



RS-485 Wiring



2.7 External Memory Card:

There are two types of external storage for the User. One is the SD card and the other is USB memory. There are two slots for inserting USB memory, one in the front and the other on the rear side of the recorder. If bigger capacity USB memory is required, the user may buy it locally. The SD card slot is in the front side. Please see the below figures for more information.

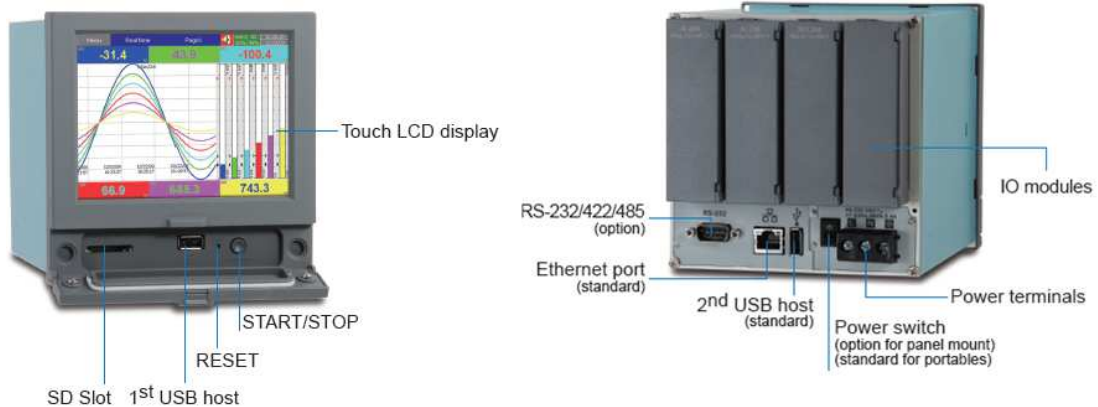

Note:

- ◆ To read measured data and events on USB memory and SD card Memory, it is necessary to install either the free basic software or the Extensive Data Acquisition software on PC first.

3. BASIC FUNCTIONS OF RECORDERS

In this chapter we will be briefly explaining the functions that are available in the recorder.

3.1 Configuration

The configuration in the recorder follows a tree type layout. This makes it easy for users to go through the different sub menus easily and to not miss any setting.

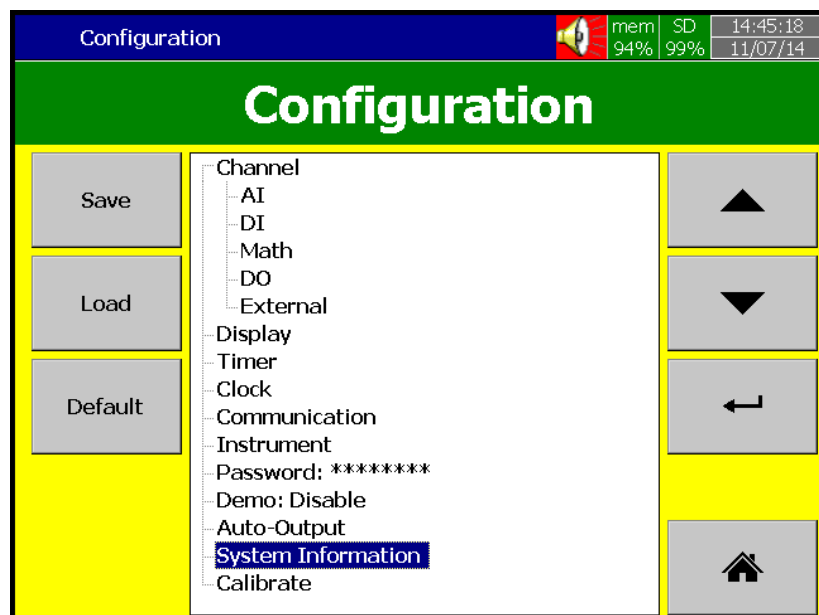

3.2 Standard and Plus Version of Firmware

The standard version of firmware will have Input configuration and Math functions. It does not include External channels, Custom Edited Display, Batch, or FDA CFR part11 functions. However, the plus version includes all the above listed functions.

Math: It includes Math, Counter & Totalizer.

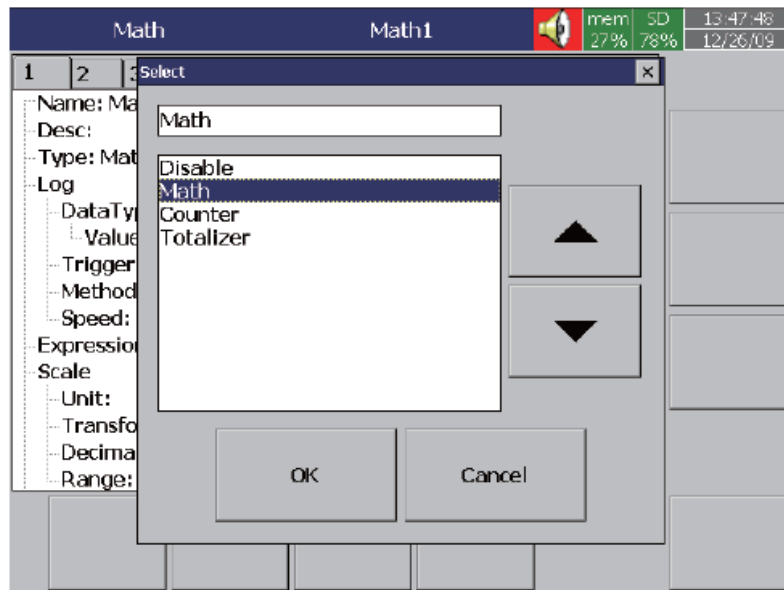

Math Expression is keyed in an easy way.

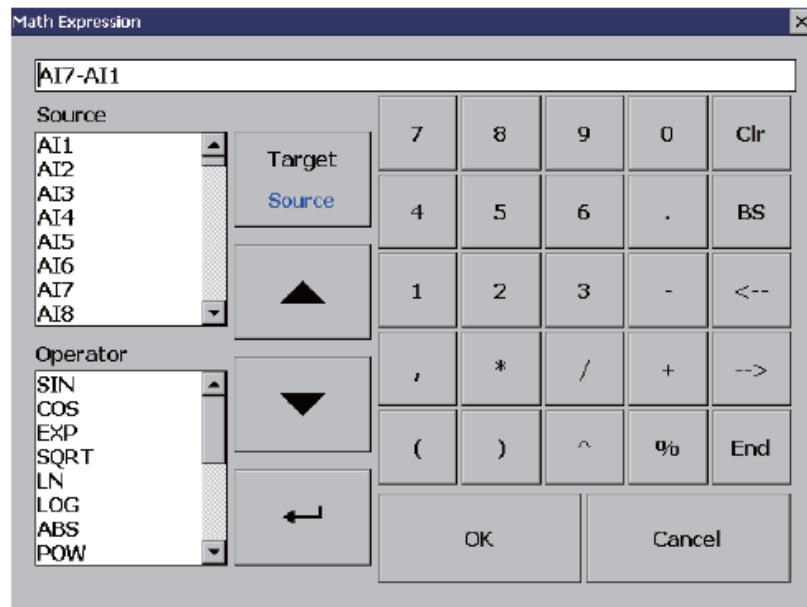

3.3 Communication with Third Party Interfaces

The Recorder has the flexibility to communicate with Third party Interfaces via protocols such as Modbus TCP/IP or Serial connections as either a Modbus Master or Modbus Slave. The detailed settings related information can be found in Chapter 4, Configuration, and Section 4.5.

3.4 Information Accessibility through WEB

Web Server:

The Recorder Trend and Digital data can be viewed in any place in the world if we have Web Server connectivity. For this the Recorder should be connected to Internet with a fixed IP address provided by the Internet Service provider.

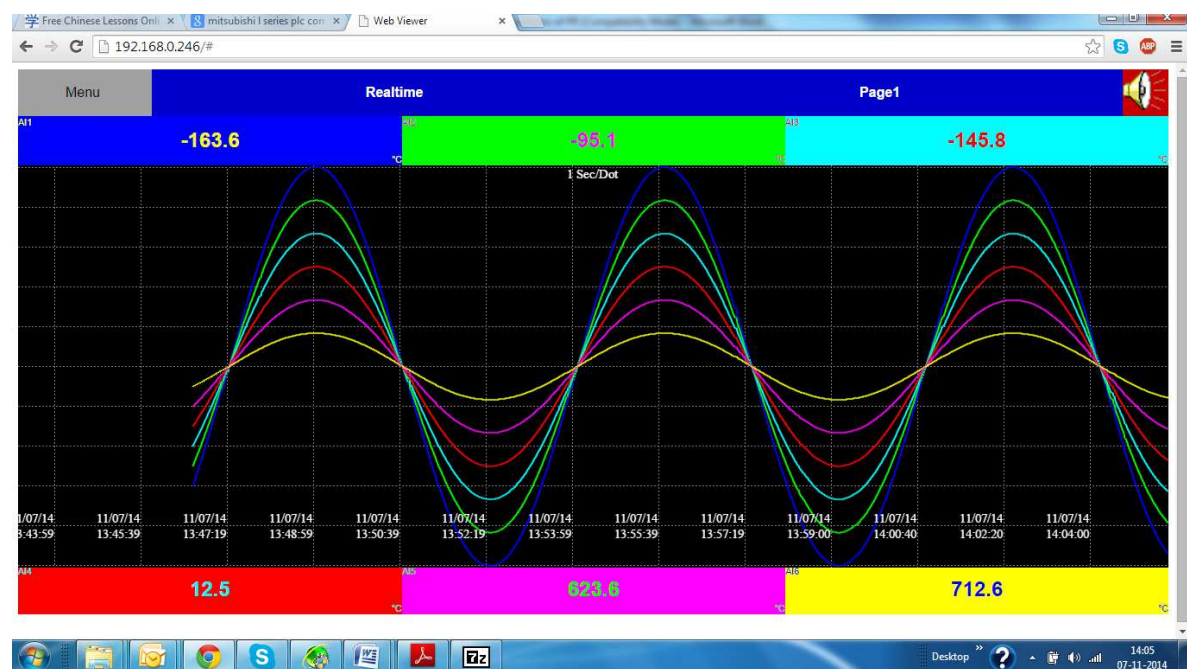

Email:

All Important Data events can be sent as an email. The detailed settings related information can be found in Chapter 4, Configuration, Section 4.5.

3.5 Handwriting Messages on Trend Screens

Handwriting Messages on Trend Screens is very handy for process associates to highlight important events.

The User can write handwritten messages using a stylus on Historical Trend screens. This is shown in the below picture.

When the User navigates through  (Menu) - \rightarrow History \rightarrow Page 1, as shown in the below screen.

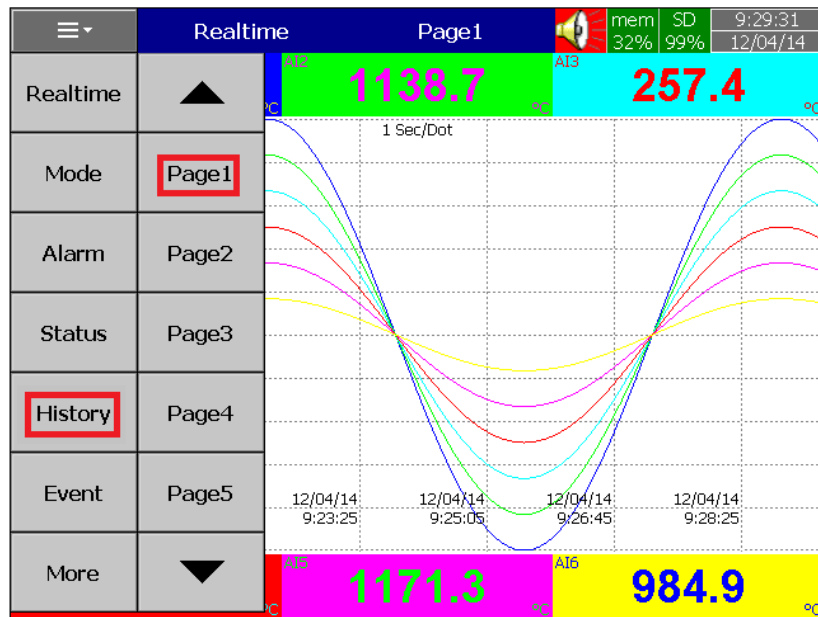

If the User wants to write a message, they can press the pen symbol as shown in the red square in the screen below

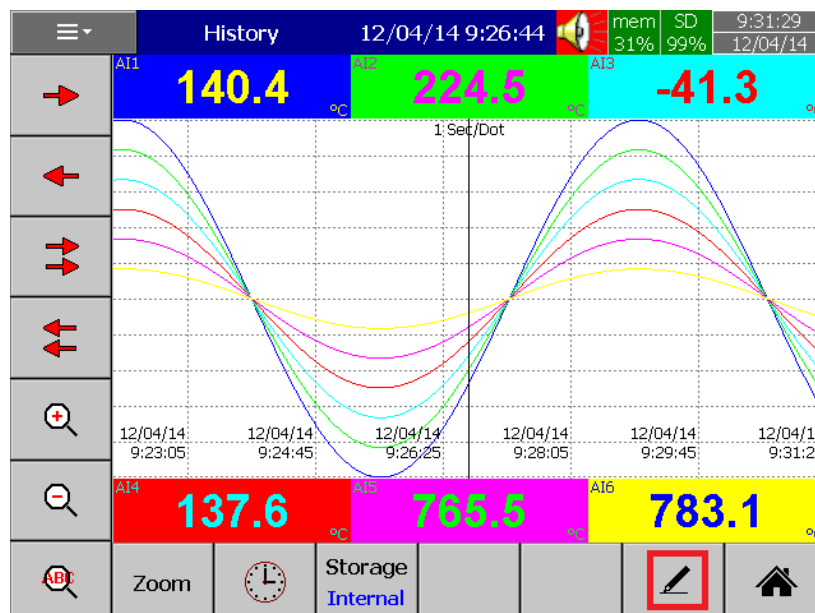

Then using the stylus, the User can write any message in Historical Trend Pages as shown below.

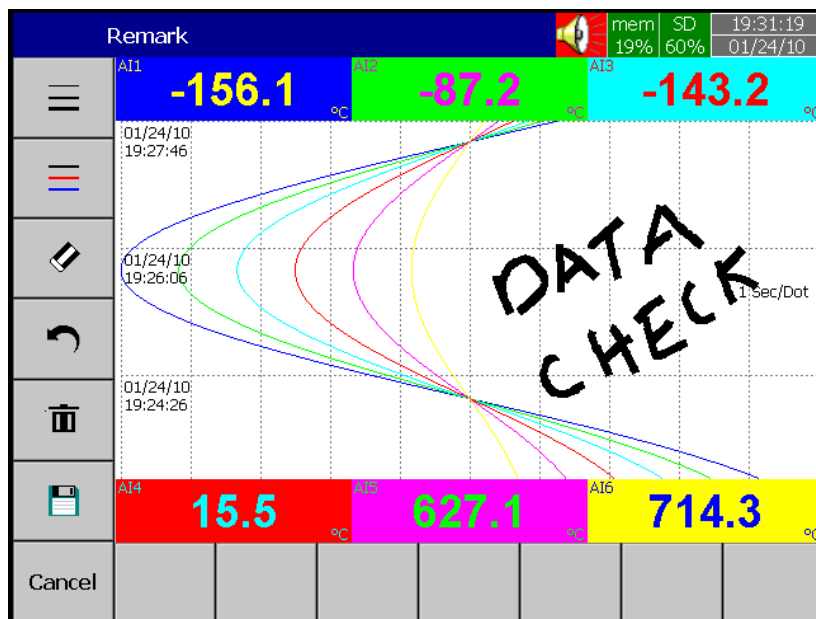

If the User wants to change the width of the written message, he/she can choose the width of pen as shown in the screen below. The menu to change the width is shown by the arrow pointing to the red box.

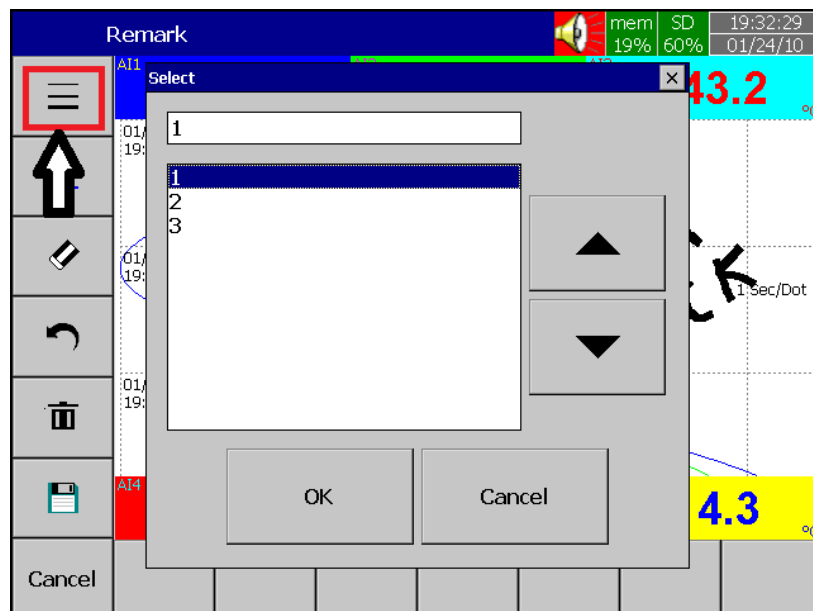

If the User wants to change color of the pen, he/she can change it by pressing the menu shown in the red box in the picture below.

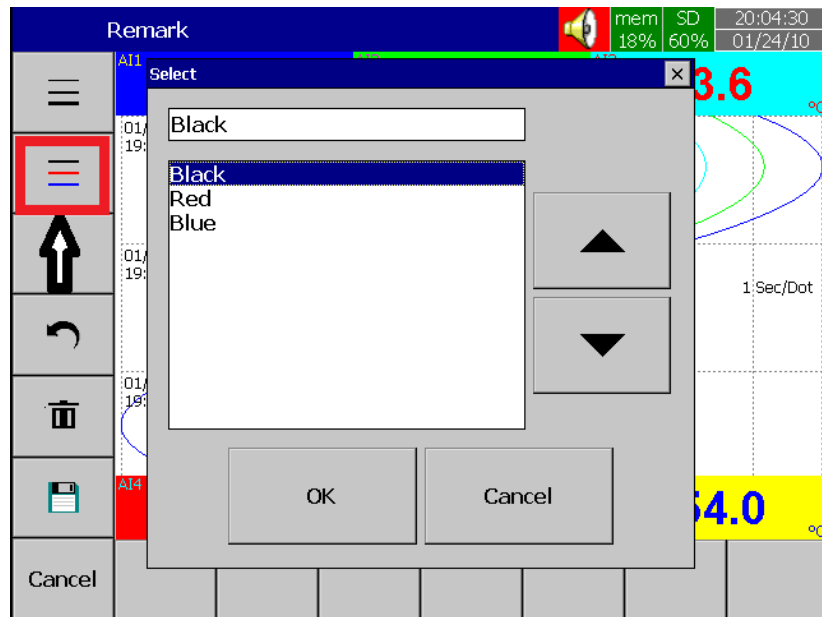

If the User wants to erase part of a message, he/she can do this by pressing the menu (shown in the red box in the picture below), and erase part of the message.

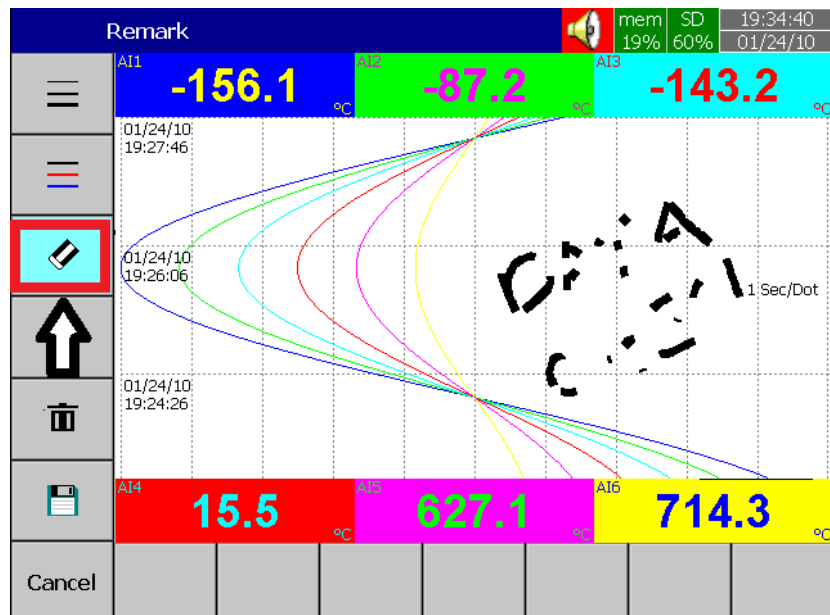

If the User wants to undo part of a message, he/she can do this by pressing the undo symbol (shown in the red box in the picture below). This will undo the last part of the message.

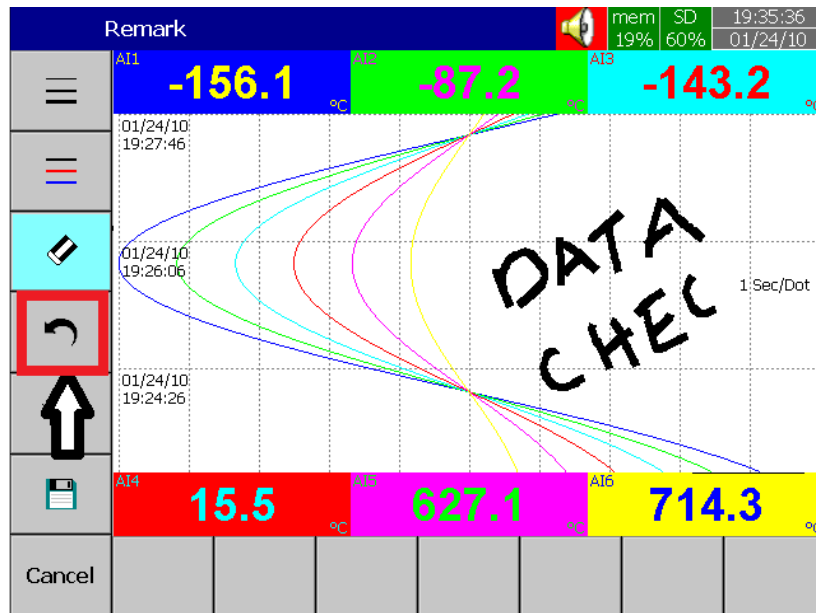

If the User wants to delete the written message, he/she can do this by pressing the delete symbol (shown in the red box in the picture below), and this will delete the written message.

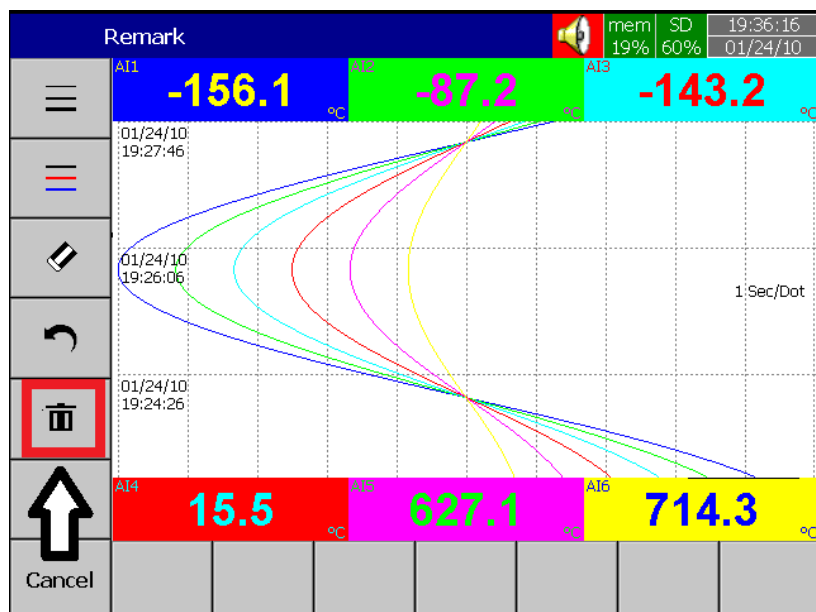

If the User wants to save the written message, he/she can do this by pressing the "save" symbol (shown in the red box in the picture below). This will save the written message.

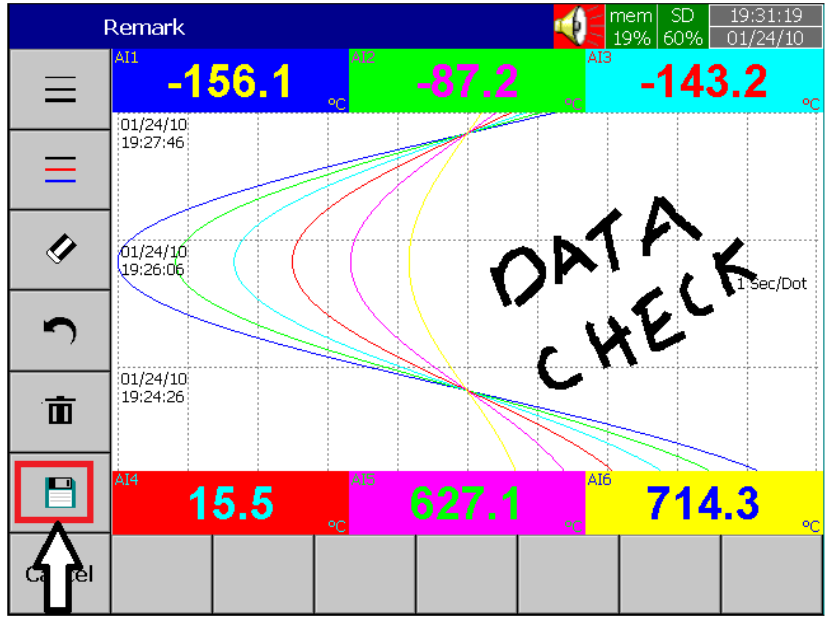

3.6 Custom Edited Display Screens

(We call it a Custom Page on the device and Custom Page Editor on PC software)

In Plus versions, the PC software Panel Studio allows users to have custom edited displays linked with Analog and Digital Tags.

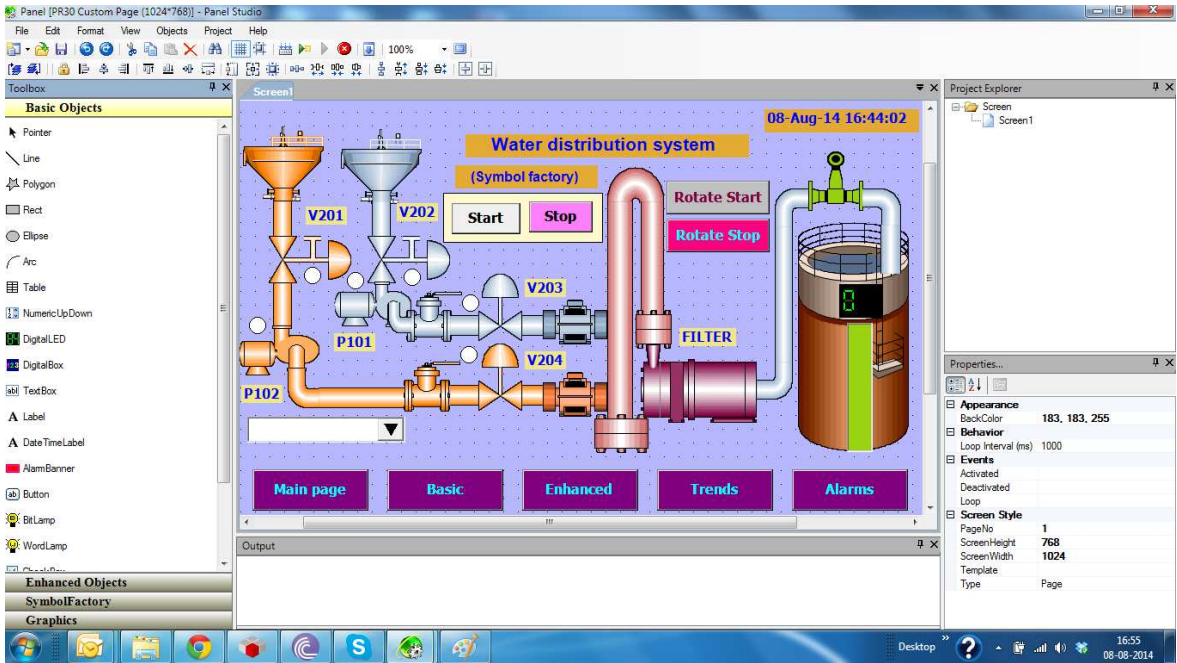

3.7 Analog Input Log Speed Flexibility

The Analog input can be logged at various speeds such as 100ms, 1, 2, 5, 10, 20, 50 Dot/sec and 1 or 2 dot/min. The User has a lot of flexibility in logging speeds.

3.8 High Speed Input

The Digital input can be accessed as normal Logic or a High frequency pulse.

3.9 System Clock Synchronization via Internet

The Recorder System clock can be synchronized via internet and Summer Saving Time can be defined. The detailed settings related information can be found in Chapter 4, Configuration, Section 4.4.

3.10 Increased Security in Password configuration

The password can be configured as normal or CFR-21. For normal, there is only one password defined but for CFR-21 three 9 levels of password definition. The related settings information can be found in Chapter 4, Configuration, Section 4.7.

3.11 Auto Output to Printer

The daily or shift reports data can be printed automatically by a Printer. The related settings information can be found in Chapter 4, Configuration, Section 4.9.

3.12 External Channels

Besides AI and DI inputs, the Recorders can accept inputs through Modbus communication. The PR10, PR20, and PR30 can have a maximum of up to 24, 48 and 96 channels respectively. The related settings information can be found in Chapter 4, Configuration, Section 4.1.6.

3.13 Batch

Using this function, the recorded data can be stored in batches per shift. This makes it easy for the production personnel, and for quality and quantity management.

3.14 FDA 21 CFR PART 11

This feature is meant to comply with U.S. Food and Drug Administration with human health concern. When this feature is enabled, the recorded data cannot be manipulated.

4. CONFIGURATION

Press  ("Menu"), then the "More" soft button to enter Configuration mode. A vertical list appears with a provision to configure Channel, Tools, Message, Display, Instrument, Security, Auto-Output, Demo, and system Information. In addition, the Save, Load, Default and Home soft buttons also appear.

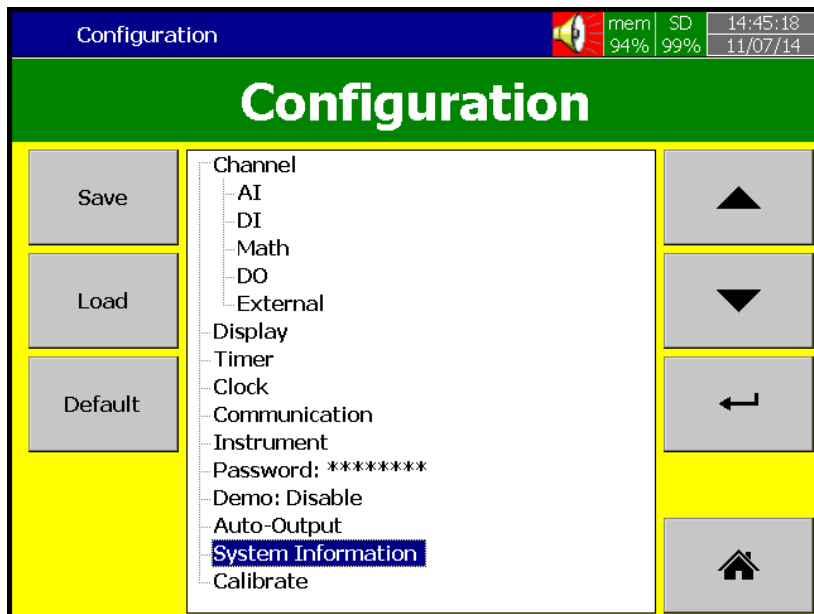

Soft buttons



Enter key



Up directional key



Down directional key



Home key

Various options are available to enter into configuration mode

Option-1: Select the mode by pressing up & down directional keys, then press "Enter" key

Option-2: Select the required mode directly with a touch, then press "Enter" key

Option-3: Select the required mode by pressing the mode two times quickly, it is same as a double click from a mouse

Save: Save configuration from the recorder to a USB Stick or an SD Card.

To read the configuration from a USB Stick for the first time or any time the configuration has been changed, it is important to press the “Save” soft button to save configuration changes to the USB Stick or SD Card beforehand.

Load: Load configuration from a USB stick or SD Card to the recorder.

Default: If the configuration is set incorrectly, “Default” is a useful key to recall the default settings for the analog input card inserted into rear expansion slot.

Home: Returns the User to the home page.

4.1 Channel

Path:  (Menu)-More-Config-Channel

AI
DI
Math
AO
DO
External

This section is to configure different type of channels. Analog Input (AI), Digital Input (DI), Math, Analog Output (AO), Digital Output and External device channels.

4.1.1 Analog Input

After entering the Configuration mode, in “Channel”, select “AI”, then Press the “Enter” key to get into Analog Input Channel mode. It displays the Analog input AI1 as the first analog input channel configuration page. Press directional keys < > at the bottom to select other channels. Press directional keys ↑ ↓ on the right hand side to select the column. **After completing Configuration, press “Back” soft button, then press “Home” soft button to return to main display. All configurations will be saved automatically.**

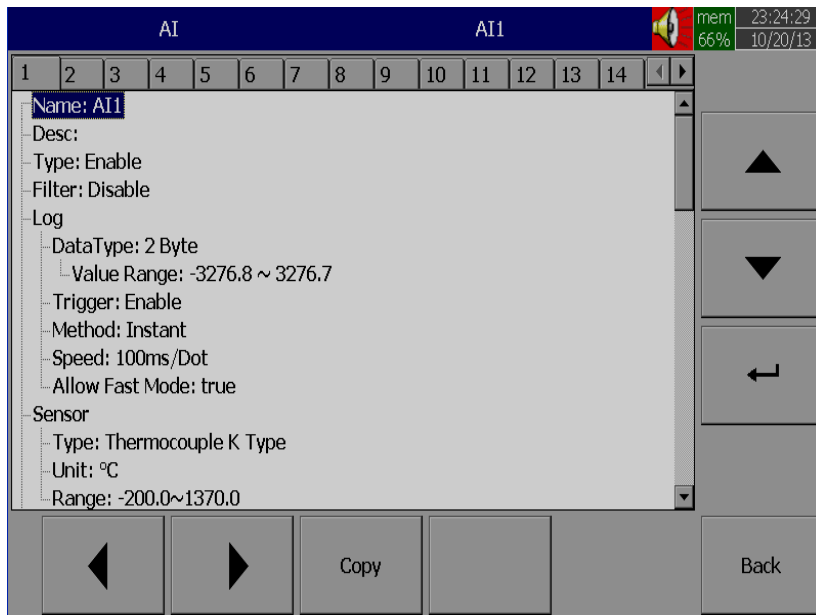

Copy: For example, to copy the channel configuration from channel 1 to channel 2, select the source channel, in this case AI1 (or whatever the channel is named), press on “Copy” button. Now, a “Paste” button will get enabled, go to target channel, say channel 2, and then press on “Paste” button.

Name: Enables the User to define the name for each channel with a maximum of 18 characters.

Select “Name”, then Press “Enter”, soft button, a keyboard with several keys appear. Press “Shift” to select special characters. Press “Caps” to select capital letters. Press soft key “OK” after entering a new channel name.

Desc: The description about a specific channel on the display.

Type: Option available to enable or disable the channel from selection

Filter: It is to reduce the noise of input signal before sampling. It is possible to select range from 1 to 16 sec. It is a soft filter available to reduce fast variation of analog inputs. It gives a moving average value. For example, if the filter value is set as 5 sec for AI1, it means all the samples collected in the last 5 sec shall be averaged, and the value is available to record as per Log method.

Moving Average: This takes Average of the values recorded in (entered) Buffer Time.

Difference: It is current value and last value difference. Allowance will define difference allowance. Holding time minimum is 100ms.

Example:

If current value 1000 and last value is 890, when you check the difference is 110. Since this difference is greater than 100 it is with that value more than the holding time, This value will be recorded. If the difference of current and last recorded value is greater than “difference value” but does not stay for the duration of holding time , this value will not be recorded. So the holding time will define the duration of noise filter.

Log:

Data Type: 2 byte

2 byte range: -32767 to +32767

Trigger: Two options are available

- a) Disable: Select disable while the recording of a specific channel is not required at this time
- b) Enable: Select Enable while the recording of a specific channel is required at this time

Method: This is the method of logging measured data. Select the column and press “enter”. Then choose the Log method of Instant, Average, Minimum or Maximum data.

Instant: logging the last measured data at the sampling interval

Average: logging the averaged measured data at the sampling interval

Minimum: logging the minimum measured data at the sampling interval

Maximum: logging the maximum measured data at the sampling interval

Speed: It is the logging speed (recording speed) of measured data. Select Log Speed column, then choose one of the following

100ms/Dot

1 Sec/Dot

2 Sec/Dot

5 Sec/Dot

10 Sec/Dot

20 Sec/Dot

30 Sec/Dot

1 Min/Dot

2 Min/Dot

(Auto)Set Jobs under Events

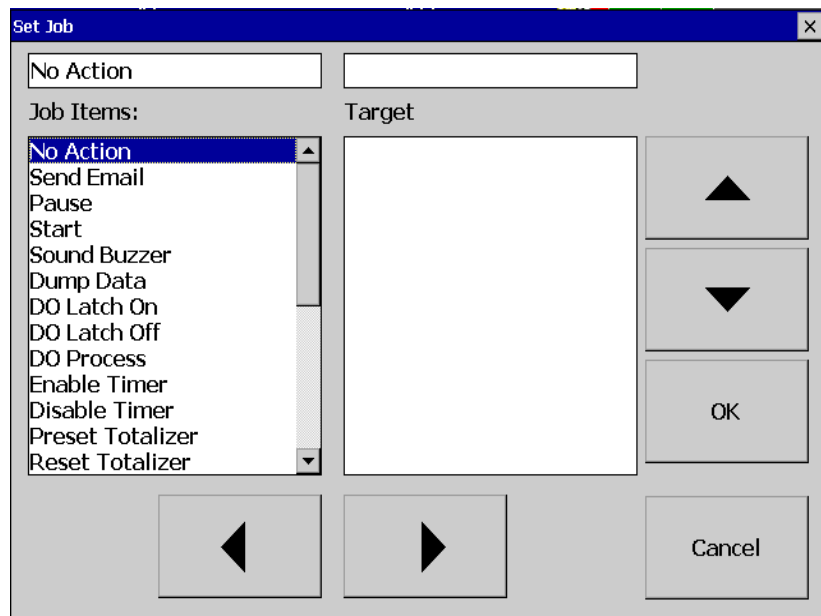

Sensor

- Type: Thermocouple K Type, °C
- Unit: °C
- Range: -200.0~1370.0

Type: Select the sensor input type for the Channel.

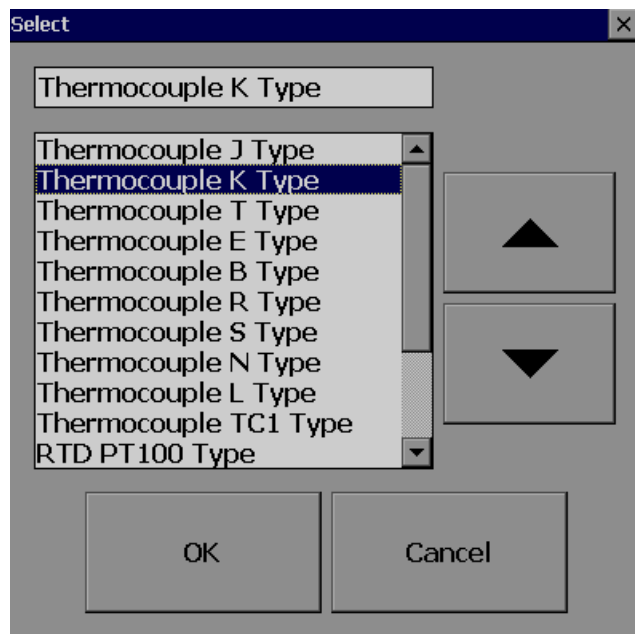

- RTD JPT100 Type
- RTD RTD1 Type
- Milli-Volts
- Volts
- Current

Unit: The engineering unit of input.

Range: Select based on Sensor type

Select

-200.0~1370.0

-200~1370

-200.0~1370.0

Sensor

Type: Milli-Volts

Unit: mV

Range: 0~1000

Select

0~1000

0~60

0~1000

-60~60

Sensor

Type: Volts

Unit: V

Range: 0~5

Select

0~5

0~10

0~5

1~5

-2~2

-20~20

Sensor

Type: Current

Unit: mA

Range: 4~20

Select

4~20

0~20

4~20

-20~20

Scale: Appears only for linear inputs Ex: mV, Voltage, current etc..

Scale

Unit: °C

Low: -120.0

High: 1000.0

Offset: It is offset value to correct the sensor error.

Gain: It is a multiplier to correct the sensor error.

The correct value = (the process value x gain) + offset

Events

Events are frequently used for Alarm purposes. Events can also be used for digital outputs (DO), Timer, Totalizer, Counter or Report.

Maximum five events are possible to set for each Analog Input

Press "Add" to add new event

Press "Remove" to remove selected event

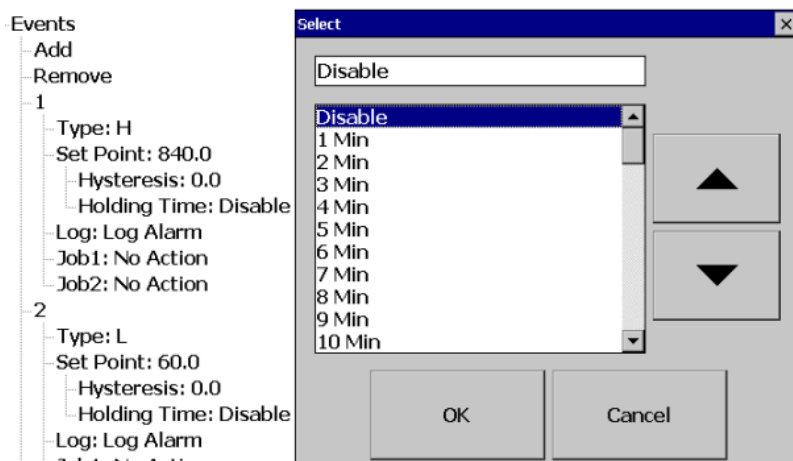

Type: There are various types of H, L, HH, LL, Dev+, Dev-, and Error to be selected for a job

or Alarm purpose

H: High limit. When the process is over high limit, the alarm or job is actuated.

L: Low limit. Any the process is lower than low limit, the alarm or job is actuated

HH: High high limit, to set up another limit higher than high limit for double warning.

LL: Low low limit, to set up another limit lower than low limit for double warning.

Dev+: Trigger event on positive deviation of process value. The job or alarm is activated when process value is deviated by greater than the setpoint+the process value.

For example:

Set point =10

At 10.00.01 Hrs, Tag1=40

At 10.00.02 Hrs, Tag1 = 51

Then, job or alarm is activated

Dev-: Trigger event on negative deviation of process value .The job or alarm is activated when the process value is deviated by less than the set point-the process value.

For ex: Set point =10

At 10.00.01 Hrs, Tag1=40

At 10.00.02 Hrs, Tag1 = 29

Then, job or alarm is activated.

Error: On channel error, an alarm or job is activated

Setpoint: To set up the process value for actuating Job1 and /or Job2

Alarm

Log Alarm: Record alarms

Log Alarm (Auto Ack): Record alarms and acknowledge automatically

Log Event: Record events

Job1, Job2: When an event occurs, the task to be performed is called the job. A typical example is to trigger **an alarm buzzer** in the event of a high temperature. Each pen can accept five different types of events (or alarms) and each event can create two jobs. Please note that a job under Event is different from a job created by pressing the **Operate** key. The former is actuated by an event, and the latter is actuated by manual control, no event necessary.

Note: Please refer to the section **“Jobs”** for full details about various jobs available

Hysteresis: To avoid it been activated too often, the Log Alarm or relay can set for no reaction. Hysteresis value can be defined for the event trigger set point.

Holding time: Here refers to, suppose the set point is reached, but you want to wait for some time to activate that action. This time is holding time. In process sometimes SP is reached but it will go down immediately, that might due to process instability. To counter this, we have given a holding time, to see that PV stays at above that SP more than the holding time and then we activate action for that event. The range of holding time is 1 min to 60 min.

Example1

If the temperature is increased to more than 120 °C, logs alarm and switches on digital output 1 only after 1 minute holding time defined in the setting. When the temperature is decreased to less than 80 °C, logs the alarm and switches off the digital output1 only after 1 minute holding time defined in the setting.

Setting of events for the analog input in the channel configuration is as follows,

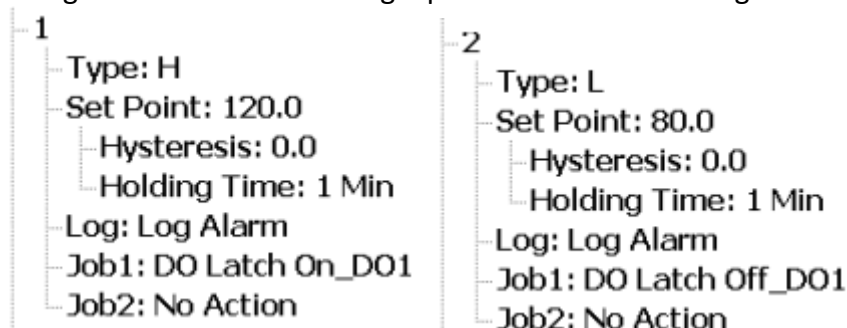

4.1.2 Digital Input

Path:  (Menu)-Config-DI

After entering the Configuration mode, in the Channel, select DI then Press the “Enter” soft button to get into Digital Input Channel configuration page.

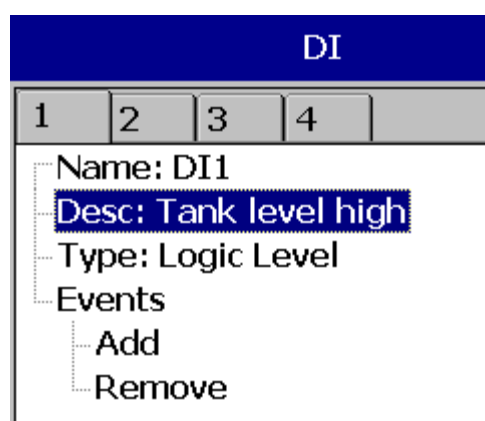

Name: Define the name for the Digital Input Channel. A maximum of 18 characters is allowed for the name.

Description: Define detail description for the channel.

Type: Logic Level

Logic Level: This selection activates digital logic, which is either one or zero with low frequency which is less than 1Hz, such as an external relay.

Pulse Counter: With this selection, we can feed high speed inputs (high Frequency, up to 100Hz)

Select Logic Level and press "Enter" key

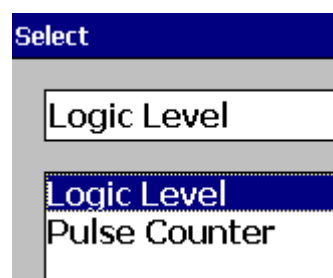

Events: A maximum of 2 events are supported for every digital Input channel. A maximum of two jobs can be configured for each event.

**Note: Events will not appear if Logic Level selected as Pulse Counter*

Add: Press "Add" to add events to the Digital Input

Remove: Press "Remove" to remove events from the Digital Input

Type: Select Low, L or High, H

Job1, Job2: To configure a Job, select Job1, the press the Enter button. It will show a list of all the available jobs. Select the required Job.

Note: Number of digital inputs shown on the DI screen depends on number of Digital input cards inserted in the paperless recorder.

Sample applications of Digital input ...

After pressing a "Start" switch, latch ON Digital Output1

After pressing a "Pause" switch, latch Off Digital Output1

Start Timer, Stop Timer

Reset Totalizer, Reset Counter

Reset MaxMinAve values of all the channels etc..

It is possible to display Digital input status via status bar on any page in the paperless recorder. If digital input is not enabled, it shows as “Low”. Presence of an enabled digital input shall be shown as “High”. See the picture below. To configure status bar, refer section “Display”

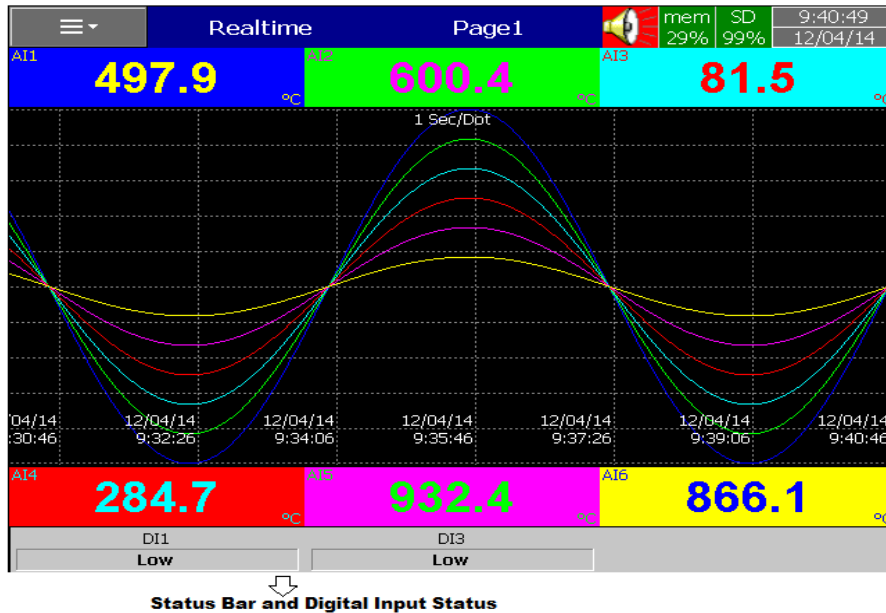

Digital Input status can also be monitored from the  (Menu). Press “Status” and then select “DI”, it will show the Digital Input Status as follows.

Menu		Status			DI	
DI	DO	AO	Counter	Totalizer		
No	Name	Value		Desc		
1	DI1	Hi		Tank1 Level switch high		
2	DI2	Low		Tank2 Level Switch High		

4.1.3 Math Channel

Maximum no. of Math channels in various PR series Recorders are as follows

PR Recorder	PR10	PR20	PR30
Maximum Math Channels	15	40	60

Path:  (Menu)-More-Config-Math

After entering the Configuration mode, in Channel, select Math, then Press the “Enter” soft button to get into Math Channel configuration page.

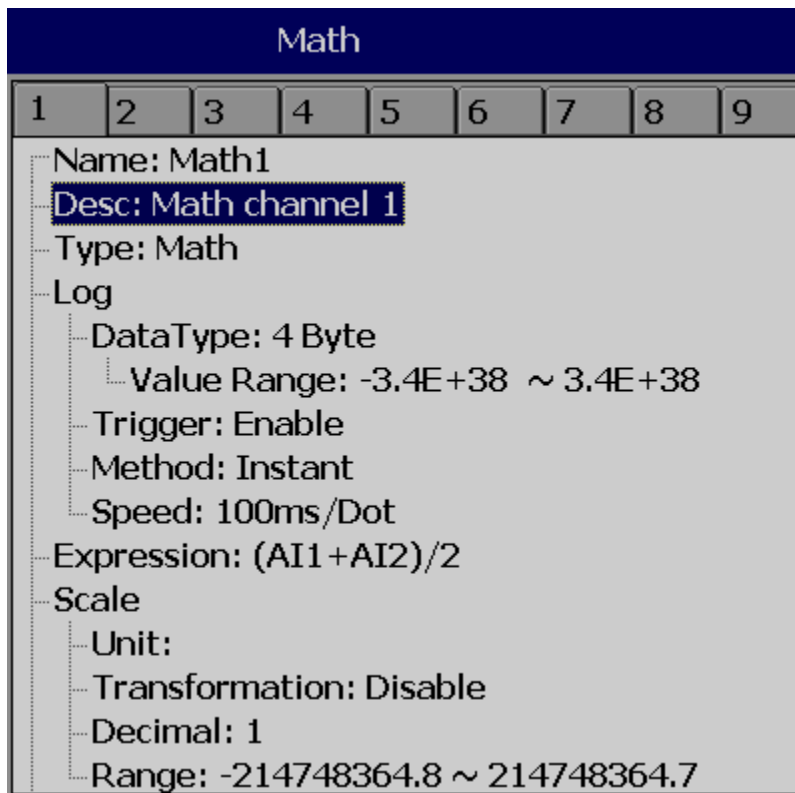

Name: Define the name of the Math channel

Desc: Define the detail description for the channel name

Type: Specify either Math, Totalizer or Counter

Note: Based on selection at “Type”, configuration details will be changed. For ex: Type=Math has different configuration details compared with Type = Totalizer or Type = Counter

Log data type, Trigger, Method, Speed: Same as Analog Input

Press **Back** key and then press “**Home**” soft button go to Real time display and memorize the Math settings.

Enter Expression column, it appears Source, Operator and a keyboard.

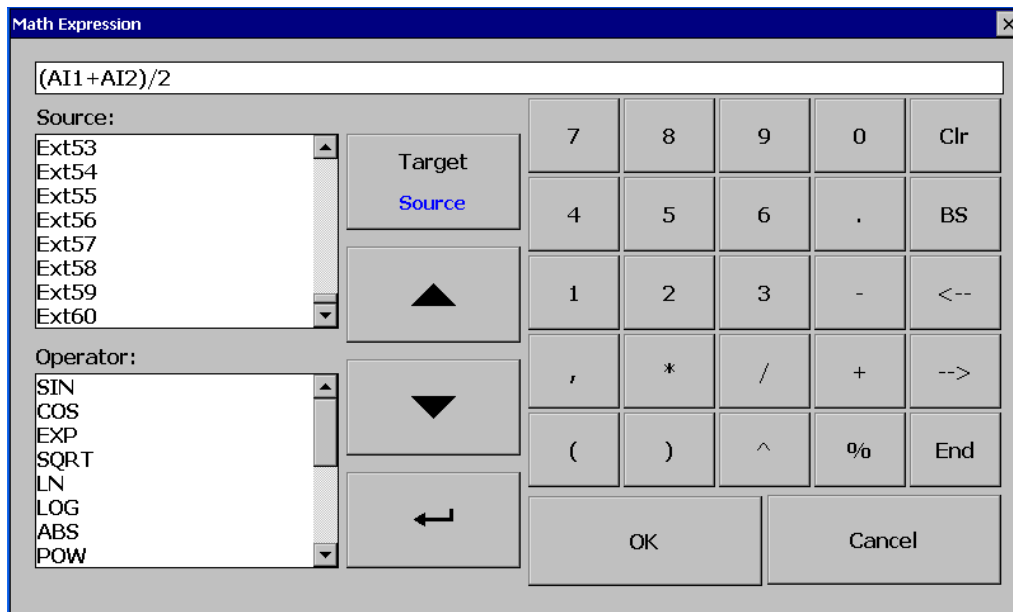

The Source covers all available Analog inputs, Digital Inputs, Math inputs, external channels.

The Operators are mathematical expressions described below.

Use Source, Operator and keyboard to define the Math equation.

Scale
 Unit: Tons
 Transformation: Value
 Table: Point 1 to 8
 Range: 0 ~ 170

Transformation: Select disable, value or Math channel. This function mainly used to display process values obtained from Non-linearization table

Table: Select disable, value or Math channel

Maximum 64 rows can be entered in the Transformation table

Ex: A chemical tank has a non-linear shape. The level is 0 to 1400 cms. The Recorder should display 0 to 170 Tons as per following table

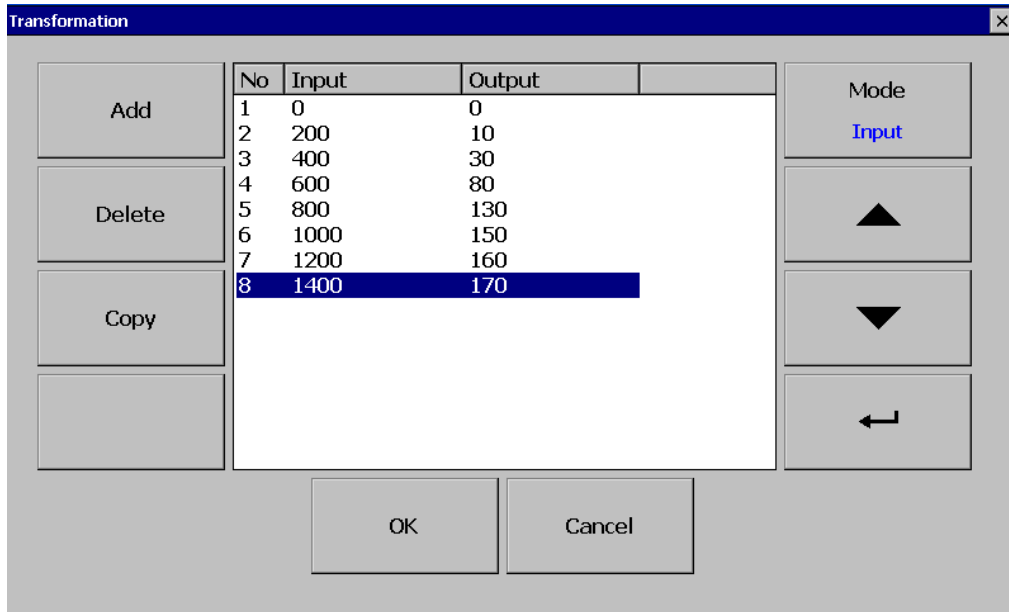

Add: Press "Add" soft button to add a new row into the Transformation table

Delete: Press "Delete" soft button to delete existing row from the Transformation table

Copy: Press to copy existing row in the Transformation table to create a duplicate entry

Mode: Press to toggle between Input and Output entries in the Transformation table

Up & Down: To navigate among rows in the Transformation table

4.1.3.1 Math Expression

Expressions	Mathematics Functions
+	Addition
-	Subtraction
*	Multiplication
/	Division
SIN(x)	$\sin(x)$
COS(x)	$\cos(x)$
EXP(x)	e^x
SQRT(x)	Square root of x
LN(x)	$\log_e(x)$
LOG(x)	$\log_{10}(x)$
ABS(x)	Absolute of x
POW (x,y)	x^y
ROUND(x)	The closest integral number to x
HI(x,y)	The bigger value between x and y
INV(x)	$1/x$
TG(x)	$\tan(x)$
CTG(x)	$1/\tan(x)$
ASIN(x)	$\sin^{-1}(x)$
ACOS(x)	$\cos^{-1}(x)$
ATG(x)	$\tan^{-1}(x)$
x%y	Remainder of x/y
x^y	x^y

4.1.3.2 Math Example-1

Relative Humidity – PR20 Math application

*How to Calculate Relative Humidity - Theory

Requirement: Two Analog Inputs, Type: RTD

AI1: To measure dry bulb temperature

AI2: To measure wet bulb temperature

First calculate the saturation vapor pressure (E) for both the dry-bulb (Td) and wet-bulb (Tw) temperatures using the following equations:

$$E_w = 0.61078 * \text{EXP}((17.269 * T_w) / (T_w + 237.3)) * (T_d - T_w)$$

$$E_d = 0.61078 * \text{EXP}((17.269 * T_d) / (T_d + 237.3)) * (T_d - T_w)$$

In the above equations the temperatures units are Celsius and the saturation vapor pressure units are millibars. The function "EXP" is the exponential and not raising something to an exponent.

Then calculate actual vapor pressure (Ea) using the following equation:

$$E_a = E_w - 0.63 * (T_d - T_w)$$

Relative Humidity is then calculated using the following equation:

$$RH = (E_a / E_d) * 100$$

The units of relative humidity are in percent.

Here is an example of the using the equations:

Assume that your dry-bulb temperature (Td) = 40 C and your wet-bulb temperature (Tw) = 30 C.

$$E_w = 0.61078 * \text{EXP}((17.269 * T_w) / (T_w + 237.3)) * (T_d - T_w)$$

$$E_w = 0.61078 * \text{EXP}((17.269 * 30) / (30 + 237.3)) * (40 - 30)$$

$$E_w = 42.4262 \text{ millibars}$$

$$E_d = 0.61078 * \text{EXP}((17.269 * T_d) / (T_d + 237.3)) * (T_d - T_w)$$

$$E_d = 0.61078 * \text{EXP}((17.269 * 40) / (40 + 237.3)) * (40 - 30)$$

$$E_d = 73.7416 \text{ millibars}$$

$$E_a = E_w - 0.63 * (T_d - T_w)$$

$$E_a = 42.4262 - 0.63 * (40 - 30)$$

$$E_a = 36.1262 \text{ millibars}$$

$$RH = (E_a / E_d) * 100$$

$$RH = (36.1262 / 73.7416) * 100$$

$$RH = 48.99 \%$$

* End of Theory

5 Math channels are required to calculate one RH.

Td = AI1, analog input for dry bulb temperature (PT100)

Tw = AI2, analog input for wet bulb temperature (PT100)

Math1 = EXP ((17.269*AI1)/ (AI1+237.3))

Math2 = Ed1 = 0.61078*Math1*(AI1-AI2)

Math3 = EXP ((17.269*AI2)/ (AI2+237.3))

Math4 = Ew1 = 0.61078*Math3*(AI1-AI2)

Ea = Ew - 0.63 * (Td - Tw)

Math5= RH1 = ((Math4-0.63*(AI1-AI2))/Math2)*100

Name: Math1
Desc: Math Channel 1
Type: Expression
Log
Expression: EXP((17.269*AI1)/(AI1+237.3))

Name: Math1
Desc:
Type: Math
Log
DataType: 4 Byte
Value Range: -3.4E+38 ~ 3.4E+38
Trigger: by Time
Method: Instant
Speed: 1 Sec/Dot
Expression: EXP((17.269*AI1)/(AI1+273.3))

Name: Math2
Desc:
Type: Math
Log
DataType: 4 Byte
Value Range: -3.4E+38 ~ 3.4E+38
Trigger: by Time
Method: Instant
Speed: 1 Sec/Dot
Expression: 0.61078*Math1*(AI1-AI2)

Name: Math3
Desc:
Type: Math
Log
 DataType: 4 Byte
 Value Range: -3.4E+38 ~ 3.4E+38
 Trigger: by Time
 Method: Instant
 Speed: 1 Sec/Dot
Expression: $\text{EXP}((17.269 \cdot \text{AI2}) / (\text{AI2} + 273.3))$

Name: Math4
Desc:
Type: Math
Log
 DataType: 4 Byte
 Value Range: -3.4E+38 ~ 3.4E+38
 Trigger: by Time
 Method: Instant
 Speed: 1 Sec/Dot
Expression: $0.61078 \cdot \text{Math3} \cdot (\text{AI1} - \text{AI2})$

Name: Math5
Desc:
Type: Math
Log
 DataType: 4 Byte
 Value Range: -3.4E+38 ~ 3.4E+38
 Trigger: by Time
 Method: Instant
 Speed: 1 Sec/Dot
Expression: $((\text{Math4} - 0.63 \cdot (\text{AI1} - \text{AI2})) / \text{Math2}) \cdot 100$

Now, in Math5, you will get Relative humidity in %

Five events are supported for every Math channel and two jobs are available in every event, the same as the Analog input channel.

Math channels are virtual channels. They contain measured values based on equations. These values can be recorded similar to physically connected Analog inputs and display digital values, trends, bar graphs etc.

4.1.3.3 Counter

Path:  (Menu)-More-Config/Math

Select **Type = Counter**

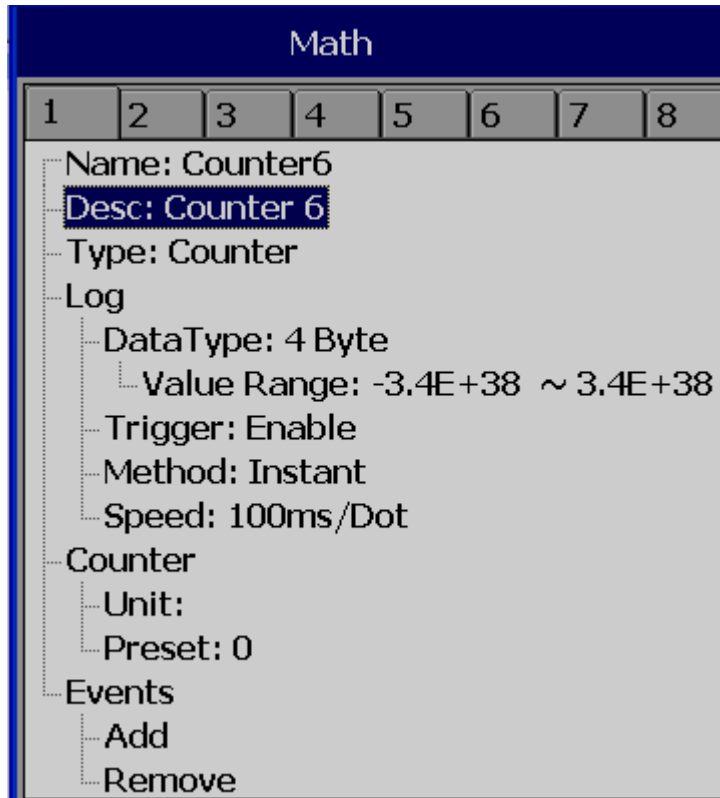

Press directional keys $\langle \rangle$ at the bottom to select one of the Math channel for the Counter operation.

Name: Defines the name of counter, max. 18 characters allowed

Desc: Defines the description for a specific counter on the display

Type: Select **Counter**

Counter

Unit: Defines the unit of counter

Preset: Defines the preset value for the counter.

Event: Defines the type, Set point, Log, Job1 or Job2 & Hysteresis

Type: Select one of the options: H, L, HH, LL, Dev+, Dev-, Error

Set point: Defines the set point trigger of Counter value to initiate Jobs and/or Log alarms

Log: Select Log Alarm, Log Alarm (Auto Ack.), or Log Event

Job1, Job2: various jobs can be assigned, 2 jobs for each counter

Hysteresis: To avoid jobs have been activated too often, it can set for no reaction.

Hysteresis value can be defined for the event trigger set point

4.1.3.4 Counter Example-1

The operator wishes to know the number of occurrences of an event in a day. Let's say the pressure switch in DI1 goes logic high

Digital input1 is used for a Pressure switch. High signal indicates High pressure, Low signal indicates normal pressure

The screenshot displays two configuration panels. The top panel, titled 'DI', has a header bar with '1' and '2' in separate boxes. Below the header, the configuration for 'DI1' is shown with a tree view: 'Name: DI1', 'Desc: Pressure Switch', 'Events' (expanded to show 'Add', 'Remove', and '1'), and under '1', 'Type: H', 'Log: No Action', 'Job1: Inc Counter_Counter1', and 'Job2: No Action'. The bottom panel, titled 'Timer', has a header bar with boxes for '1' through '7'. Below the header, the configuration for 'Timer' is shown with a tree view: 'Type: Daily', 'Action: Enable', 'Time' (expanded to show 'Hour: 23', 'Min: 59', and 'Sec: 1'), 'Job1: Log Report_Counter1', and 'Job2: Reset Counter_Counter1'.

(Reset Counter1 historical data in order to log new data for the next day)

Archive historical data by pressing the following.

 (Menu)-Event-Report, Select Daily in the Mode

If values meet the following conditions, recorder will change notation from traditional to scientific

- a. the value is more than 10^5 or less than $1/(10^5)$
- b. the value digit-length in display exceeds the allowed range

Ex: Up to 5 digits, counter displays value directly, let's say 0-99999.
100000 will be shown as 1E5, which means 5 zero's after 1
4294967295 will be shown as 4.29497E9 etc.

4.1.3.5 Totalizer

In our new generation Recorder, the Totalizer is a part of Math channels.

Configuration Path:  (Menu)-More-Config-Math

Select **Type = Totalizer**

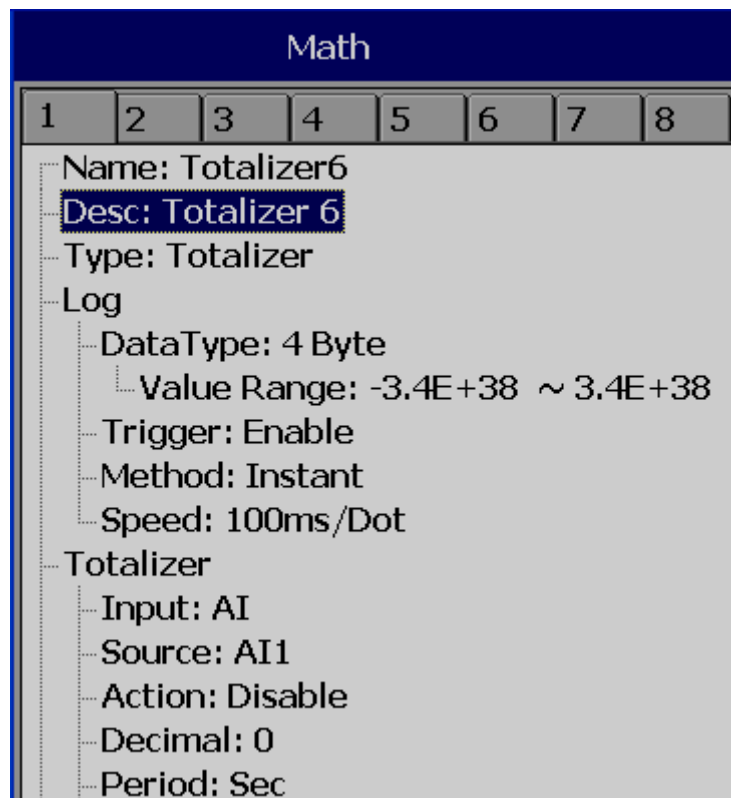

Press directional keys < > at the bottom to select from available Totalizers

Name: Defines the name of the Totalizer, Maximum 18 characters allowed

Desc: Defines the description for a specific Totalizer on the display

Type: Select "Totalizer"

Log: Same as Analog input configuration

Totalizer:

Input: Analog Input (AI) or Pulse Counter (DI)

Source: Select the source for the Totalizer from Analog input/Math/Counter/Totalizer

Action: Disables or enables the Totalizer

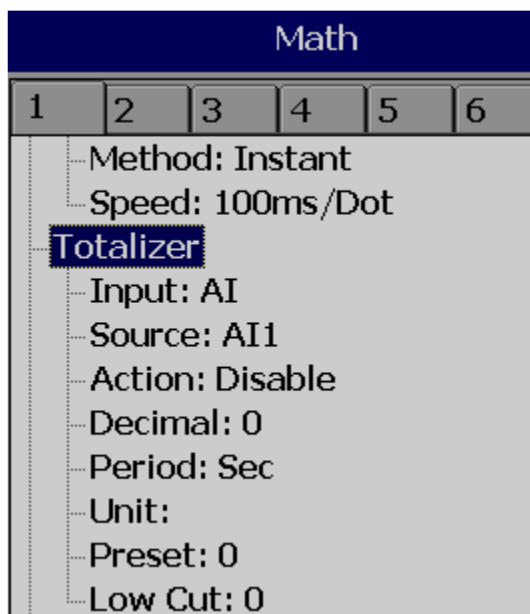

Decimal: Defines the decimal point for the Totalizer

Period: Selects if seconds, minutes, hours, days are used for the Totalizer

Unit: Defines the unit of totalizing

Preset: Defines the preset value for the Totalizer.

Low Cut: Defines the Low Cut for the Totalizer.

For ex: If 0.0 is set as Low cut, then, if source channel AI1 is less than 0.0, the Totalizer value will not go to negative.

Event: Total 5 events are supported for each Math channel. Defines the type, Set point, Log, Job1 or Job2 & Hysteresis

Type: Select one of options, H, L, HH, LL, Dev+, Dev-, Error

Set point: Defines the set point trigger of Totalizer value to initiate Jobs and/or Log alarms

Log: User can select one of Log Alarm, Log Alarm (Auto Ack.), or Log Event

Job1, Job2: various jobs can be configured, 2 jobs for each Totalizer

Hysteresis: To avoid jobs from being activated too often, the hysteresis can set to avoid nuisance tripping. Hysteresis values can be defined for the event trigger set point

4.1.3.6 Totalizer Example-1

Water flow rate is in M³/Sec. The operator wants to know about total water discharged and wants this information in daily, weekly and monthly reports

```
Name: Totalizer1
Desc:
Type: Totalizer
Log
  DataType: 4 Byte
  Value Range: -3.4E+38 ~ 3.4E+38
  Method: Instant
  Speed: 1 Sec/Dot
```

Timer						
1	2	3	4	5	6	7
Type: Daily						
Action: Enable						
Time						
Hour: 23						
Min: 59						
Sec: 1						
Job1: Log Report_Totalizer1						
Job2: Reset Totalizer_Totalizer1						

Reset Totalizer1 historical data in order to log new data for the next day

Archive historical data by pressing the following.

Path:  (Menu)-Event-Report

Select **Daily** in the **Mode** to see reports on daily basis. To navigate to another day, press on Left and right arrows below the **Mode** button. Select **Weekly** in the **Mode** to see weekly reports, or select **Monthly** on the **Mode** to see Monthly reports.

4.1.4 Analog Output

First check the AO card setting , there are DIP switches on the card and default is SET to Voltage output. For ma Output , SET 1 to 5 (ON), and 6 to 8 (OFF). Below picture explains ,

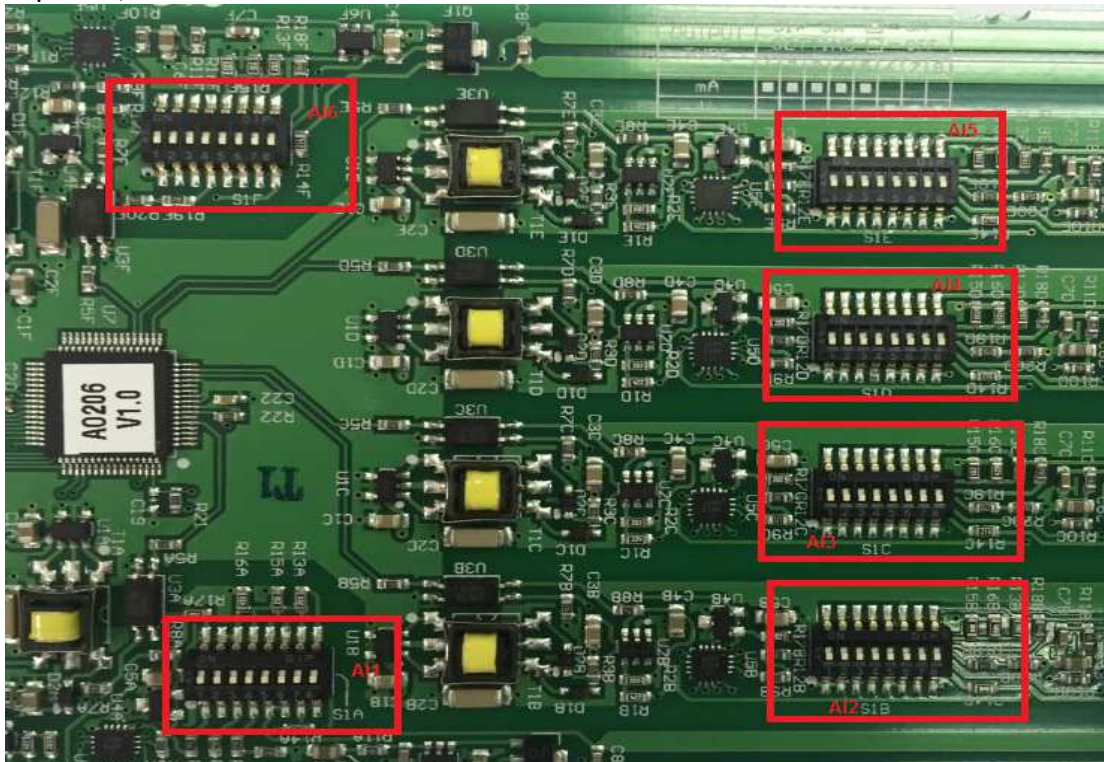

After entering the Configuration screen, in the Channel section, select AO, then Press the “Enter” soft button to get into Analog Output Channel configuration page.

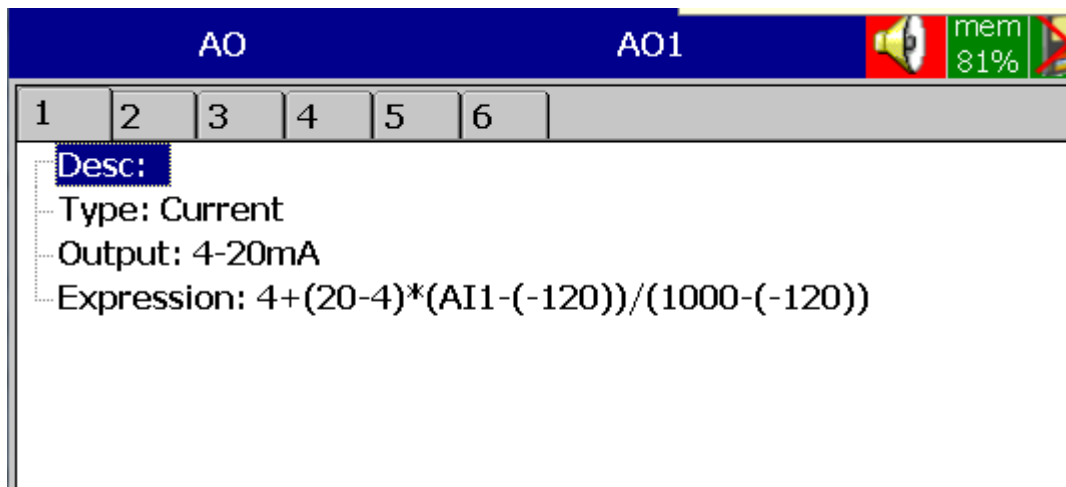

Desc: Define detail description for the channel name

Type: Current, Voltage

Output: Select either disable, 0 to 20mA , 4-20mA, 0-5V, 1-5V, 0-10VDC

Expression: This is similar to Math channel.

4-20ma output: For Retransmiting of AI1 using 4-20ma output,

Expression: $4+(20-4)*(AI1-(-120))/(1000-(-120))$

Output Value =

$Min\ ma + [(Max\ ma - Min\ ma) * (AI1 - Min\ range\ of\ AI1)] / (Max\ range\ of\ AI1 - Min\ range\ of\ AI1)$

4.1.5 Digital Output

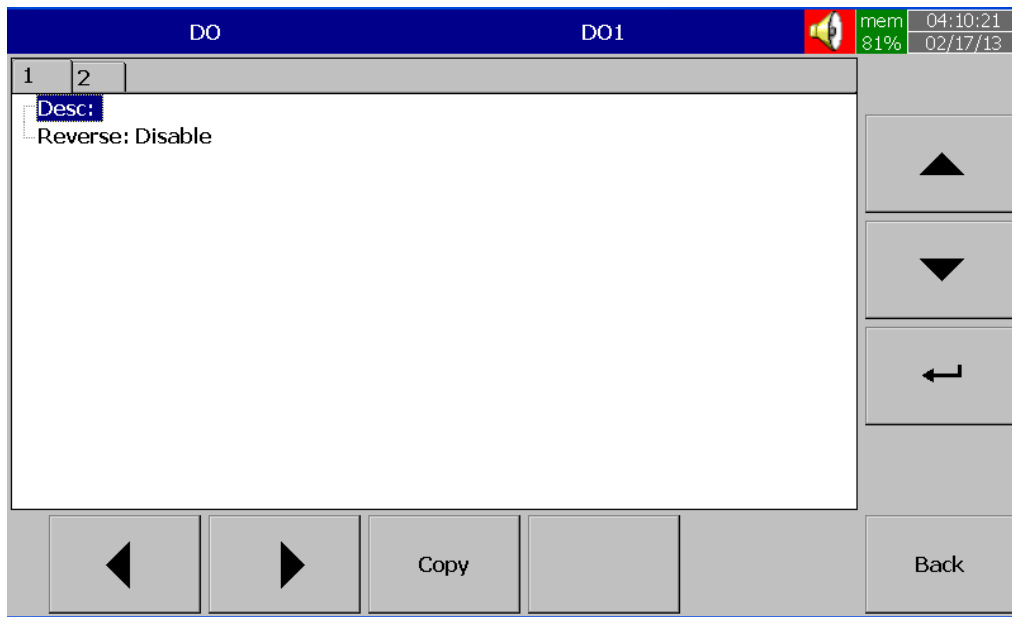

Desc: Define detail description for the channel name

Reverse: Enable this if Reverse operation is required for the Digital Output.

For ex: If reverse is disabled, the relay output is Normally Open (NO). In case if you need to have a Normally Closed (NC) relay at Recorder Power ON, then enable “Reverse” for the selected Digital Output. The Relay output shall be normally closed.

4.1.6 External

This is to access data from the external devices.

Maximum no. of external channels in various PR series Recorders are as follows

PR Recorder	PR10	PR20	PR30
Maximum External Channels	24	48	96

All the properties are similar to Analog Input channel.

More details about external channels are available at section “Communication”

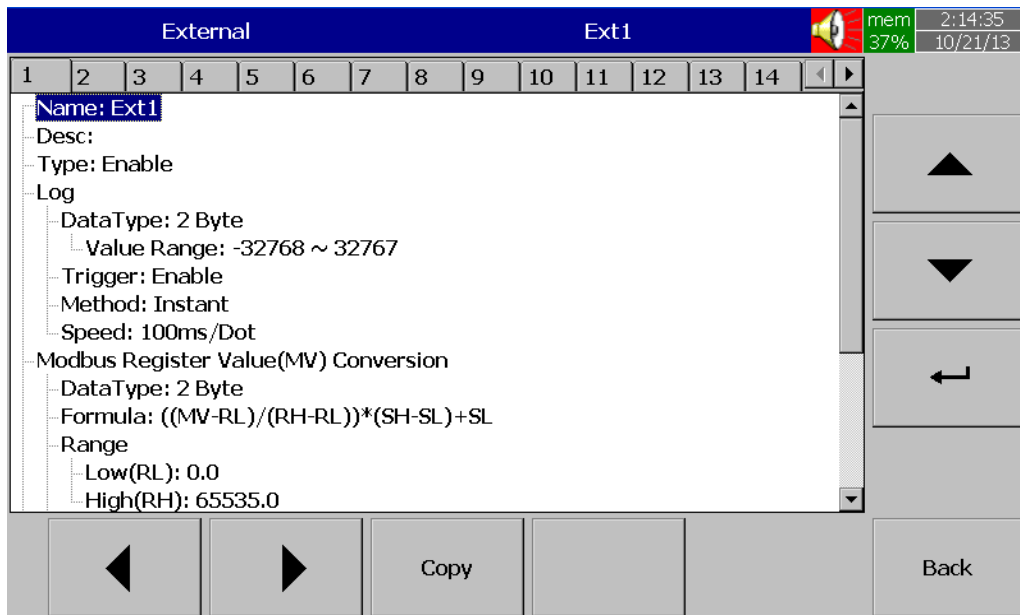

Please refer section “Communication” for examples of external channels

4.1.7 Jobs

Various types of jobs can be selected as follows.

No Action: Do nothing

Send Email: Send Email directly from Recorder

Pause: Stop logging data.

Start: Start logging data.

Sound Buzzer: Sound the buzzer. It stops once any key is pressed.

Dump Data: To dump data from internal memory to external memory. The dump data range be from initial 1 to initial 30 days and last 1 day to last 30 days.

DO Latch On: Set digital output / relay on, and then select Target, let’s say from one of DO 1 to DO 6. The relay is latched when it is activated.

DO Latch Off: Set digital output / relay off, and then select Target, let’s say from one of DO 1 to DO 6. The relay is un-latched when it is activated.

DO Process: Set digital output / relay on for process high or low, and then select the target, let's say from 1 of DO 1 to DO 6. The relay is not going to be latched when it is activated.

Enable Timer: Start the timer, and then select Target timers

Disable Timer: Stop the timer, and then select Target from Timers

Preset Totalizer: set a preset value to the target Totalizer.

Reset Totalizer: Reset Totalizer to zero. Select a single Target Totalizer or All totalizers

Enable Totalizer: Starts the Totalizer. Select a single Target Totalizer or All totalizers

Disable Totalizer: Stops the Totalizer. Select a single Target Totalizer or All totalizers

Preset Counter: set a preset value to the target counter.

Reset Counter: Resets the counter to zero. Select a single Target counter or all counters

Inc Counter: Increases the counter by 1. Select a Target counter or all counters

Dec Counter: Decrease the counter by 1. Select a Target counter or all counters

Log Report: Make a report for Counter, Totalizer, Analog inputs (Min/Max/Avg), Math (Min/Max/Avg), All Counters, All Totalizers, and All Channels (Min/Max/Avg). Choose this column, and the report will be presented as described in section "**Reports**".

Reset MinMaxAve: In the Report function, after logging the Min/Max/Avg data of AI and Math channels for one day for example, this will reset historical data in order to log new data for the next day. It is also possible to reset the Min/Max/Avg for "All Channels" at one step.

Print: If a printer is connected to the Paperless Recorder via the USB port or Ethernet, the following print jobs can be triggered from "events"

- Print Historical data
- Print Event List
- Print Report List
- Print Snapshot

The time period of Print depends on the configuration available at

 (Menu)-More-Config-Auto-Output

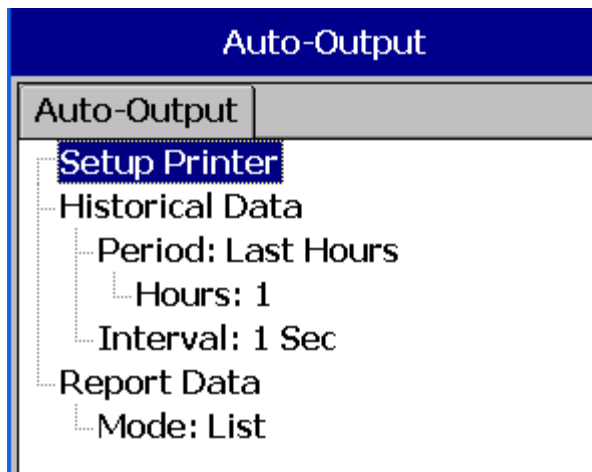
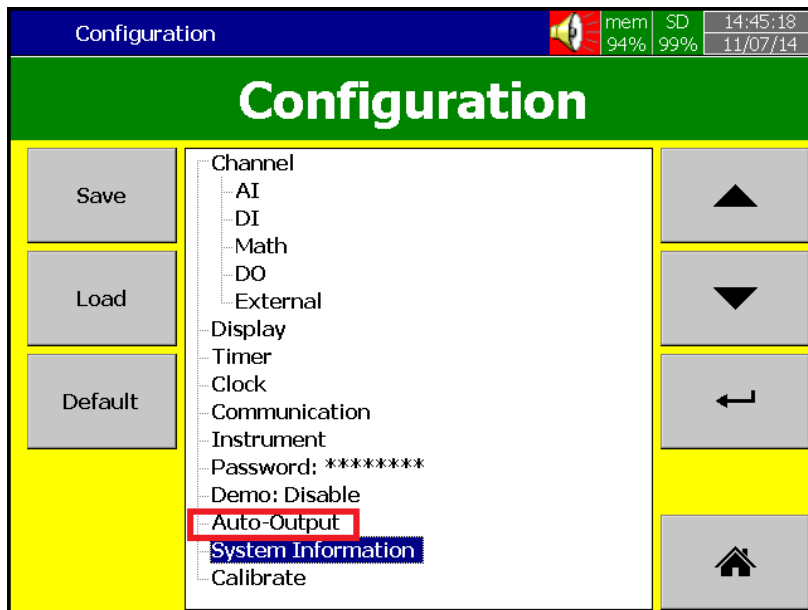

Note: Please refer section “Auto Output” for more details about options available

OutPut Historical Data: This action will generate a historical data output in the form of excel sheets on external storage. Output is in the form of .CSV files. It will contain also contain event reports.

Copy Value and Paste Value: This used for retransmission of Analog inputs using external (communication) Analog output channels. Since we have limitation of Analog outputs on the Recorder. This external channels can be utilized by using the copy value and paste value. You can do this by using event or timer when job 1 is copy value, job2 will be paste value.

Dump data: This action will dump the historical data on to the SD. this data format can be only read by our Historical viewer software. it is not in excel format as we had it in Output historical data.

Note:

- ◆ In any mode , the sampling rate of the recorder is fixed at 100 milli seconds, i.e. 10 samples are collected per second. If the logging speed is set at 1 second in Instant mode, the recorder logs the last of ten measured data values. For the same speed in Average mode, the recorder logs using the average of the Ten measured data values. For the same speed in the Maximum or Minimum mode, then the recorder logs using the maximum or minimum of the Ten measured data values.

Sampling		Logging (historical trend)	Display (real time)
Instant	100mS	the last of 10 points of data	last of 10 points of data
Averaged	100mS	the average of 10 points of data	last of 10 points of data
Maximum	100mS	the maximum of 10 points of data	last of 10 points of data
Minimum	100mS	the minimum of 10 measured data	last of 10 points of data

Press “**Home**” key to return to real-time display, all configurations will be memorized

- ◆ The Digital output DO card with relays can be set in Job1 and/or Job2. It can be viewed in “System Info” mode after it is installed into a Slot.

4.2 Display

Path:  (Menu)-More-Config-Display

Select “**Display**”, then press the “**Enter**” Soft button to get into the Display mode configuration page (shown on the following page).

	PR10	PR20	PR30
Display pages	8	20	21
Pens/Page	6	6	10

4.2.1 Display Modes

Trend:

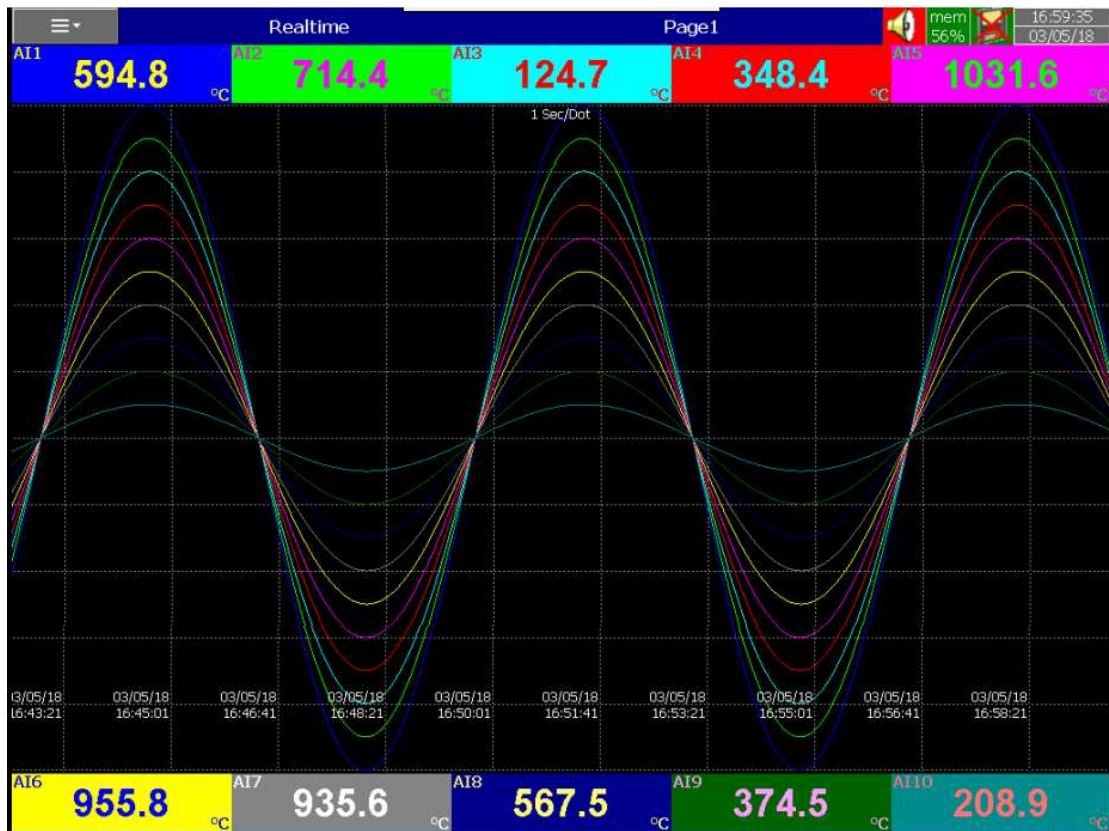

Display

1	2	3	4	5	6	7
---	---	---	---	---	---	---

- Name: Page1
- Mode: Trend**
- Speed: 1 Sec/Dot
- Direction: Horizontal
- Background: Black
- Print: Enable
- Trend Graph Scale: Disable
- Pen
 - 1
 - Channel: AI1
 - Color: Blue
 - Width: 1
 - Range
 - Low: -200.0
 - High: 1100.0
 - Reference Points: Enable
 - 1: 287.5
 - 2: 612.5
 - Trend Graph Scale
 - Position: 1

Name: Defines the name of the display page

Mode: Defines the default method of displaying data for the page.
Options are: Trend, Bar, Digital, Mix, Circular (only for PR30), Individual and Disable modes.

* Circular Trends are only available in the PR30 model.

Speed: This is the display speed. Available options are 100 msec/dot, 1 Sec/dot, 2 Sec/dot, 5 Sec/dot, 10 Sec/dot, 20 Sec/dot, 30 Sec/dot, 1 min/dot, 5 min/dot, 10 min/Page, 30 min/Page, 1 hour/Page, 2 hour/Page, 4 hour/Page, 8 hour/Page, 12 hour/Page, 1 Day/Page, 2 Day/Page, 1 week/Page, 2 week/Page, 3 week/Page, 4 week/Page, 1 Hour/Dot and 2 Hour/Dot.

Direction: Sets the trend direction to be horizontal or vertical.

Background: Sets the background color of Trend mode to black or white

Print Enable: Sets print for full screen

Trend Graph Scale: Graph scale (right side of trend) enables graph on the trend page as shown in below image

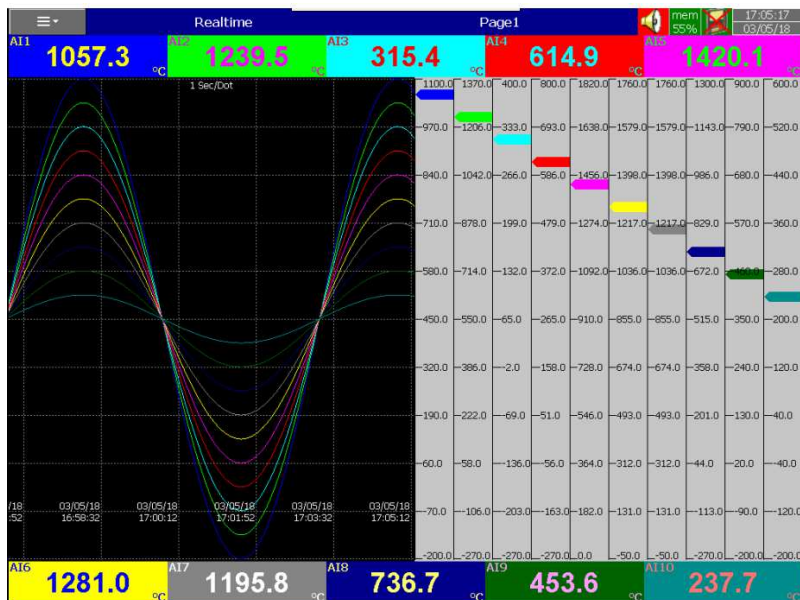

Pen: For a specific channel, this defines the drawing pen, its color, width, Range Low and Range High for the display.

Channel: Selects a specific analog input, Math, Counter, Totalizer, External channels. Select Disable if a specific channel is not required to be displayed.

Color: Selects the color for each pen.

Width: Selects the width of trend, 1-thin, 2-medium, 3-wide.

Range Low: Defines the low scale for a pen on the display.

Range High: Defines the high scale for a pen on the display.

Range Reference points: Set two reference points on the graph

Trend Graph scale position: There are 10 positions starting from left to right, User can Chose pen position on the graph

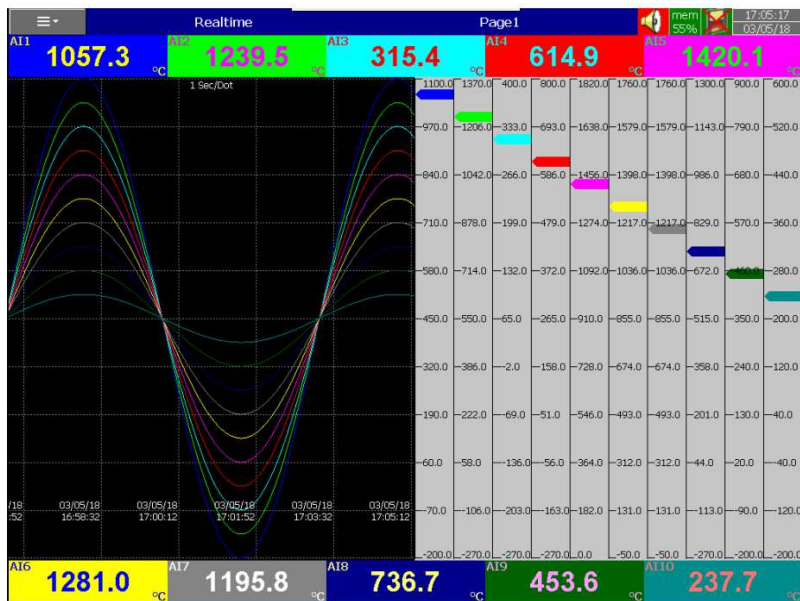

Note:

- ◆ To illustrate the difference between Display Hi, Display Lo, Scale Hi, and Scale Low, here is a typical example, with input 0-10V, Scale Low=0.00, Scale Hi=100.00, to have better resolution and vision on Bar, set the Display Lo=0.00 and Display Hi=50.00 so that the Bar displays from value 0.00 to 50.00.
- ◆ The decimal point is defined by Scale Hi and Scale Low, and not by Display Hi, or Display Lo.

Bar:

The settings for Bar are same as Trend.

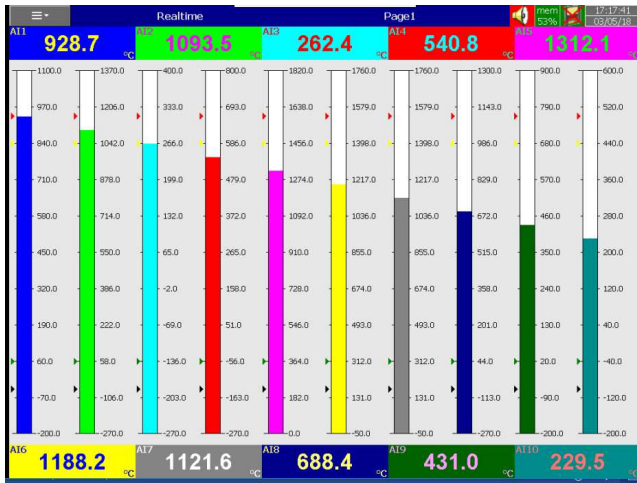

Digit:

The settings for digit are same as Trend.



Mixed:

The settings for digit are same as Trend.

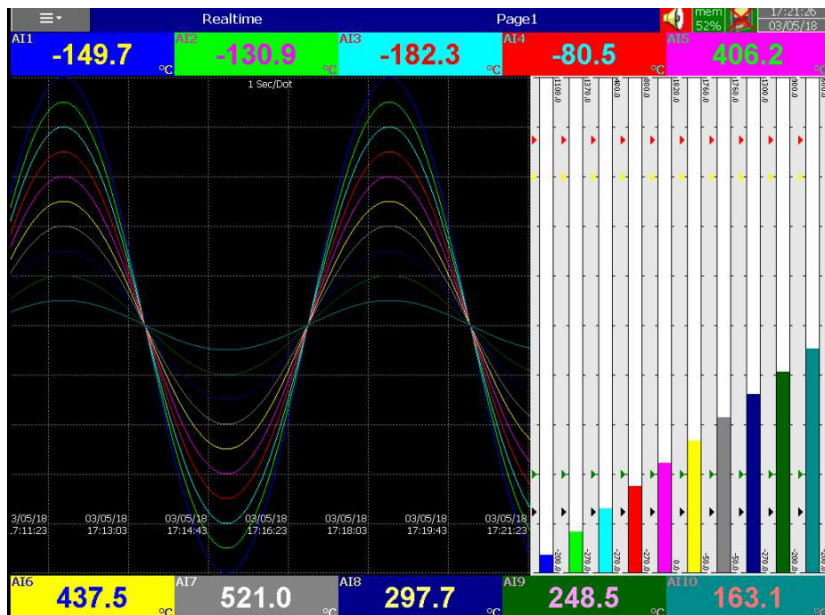

Individual:

The settings for Individual are same as Trend.

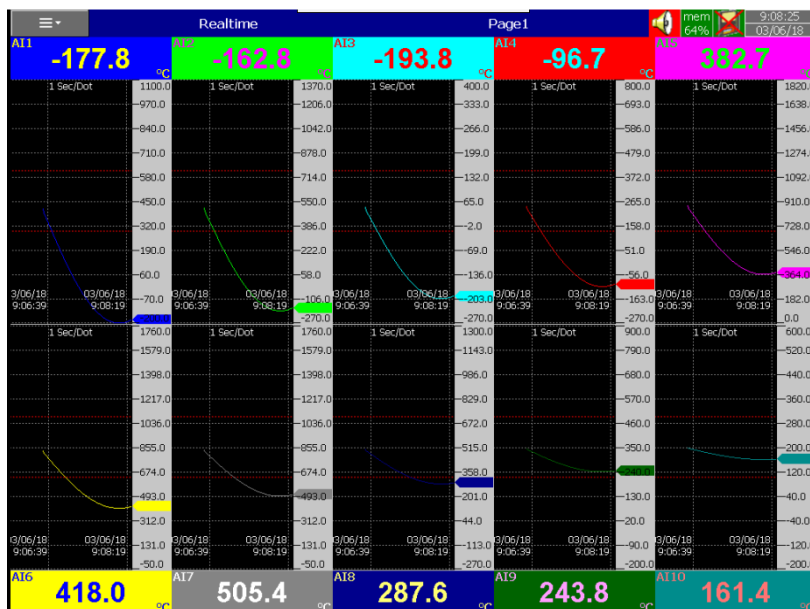

Circular:

The settings for circular are same as Trend.

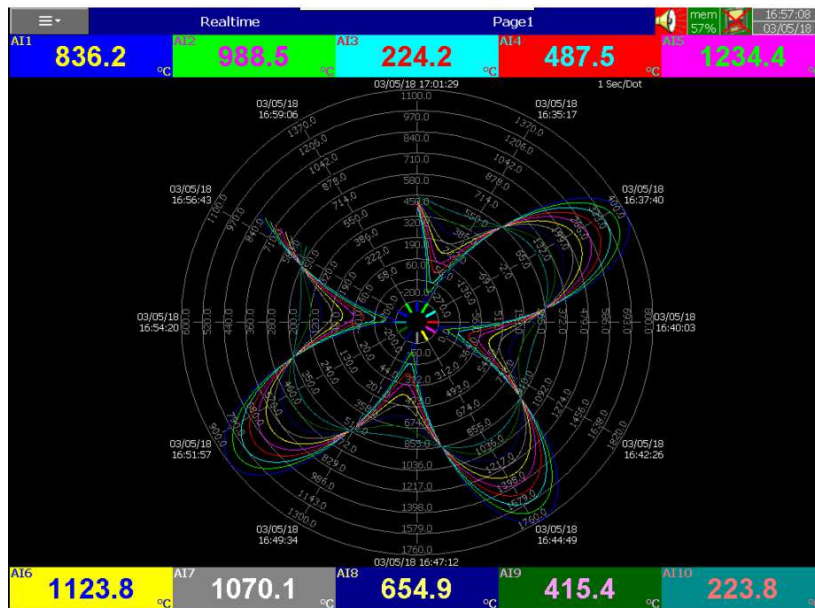

4.2.2 Status Bar

Status Bar: To make it convenient when viewing the status of Digital Input, Digital Output, Math channel, Totalizer, Counter and AO, the user may enable these items in the status bar. The Status bar is displayed at Lower part of the page. A maximum of 10 tags can be displayed in each Status bar. One status bar can be configured for each page.

Note: Status bar configuration is not shared in all the pages. You may define a different setup for status bars in each page per your requirements.

Status Bar

Type: Enable

1: DI1

2: DI2

3: DO1

4: DO2

5: Math1

6: Counter1

7: Totalizer1

8: AO1

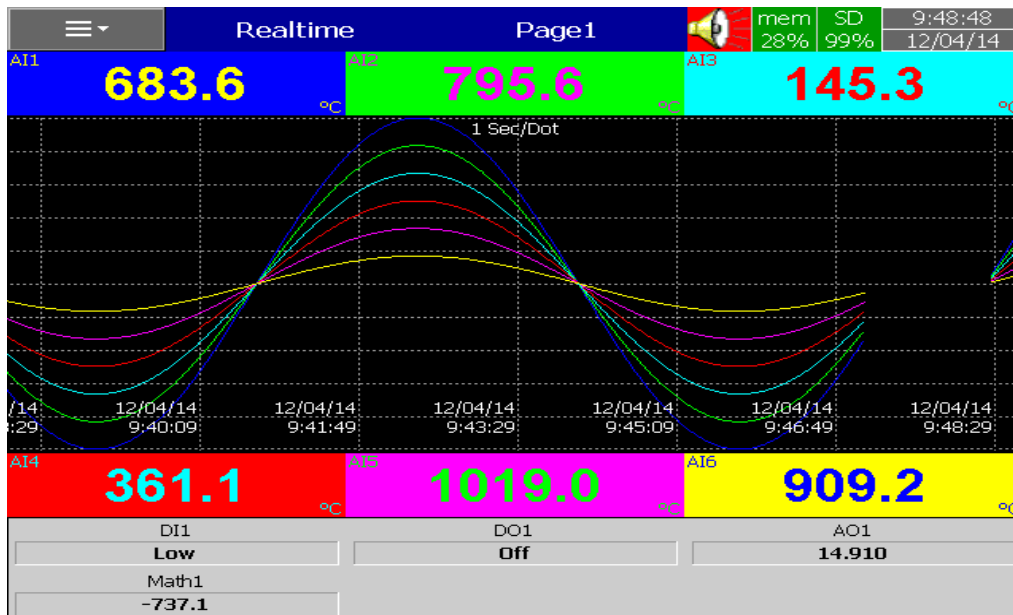

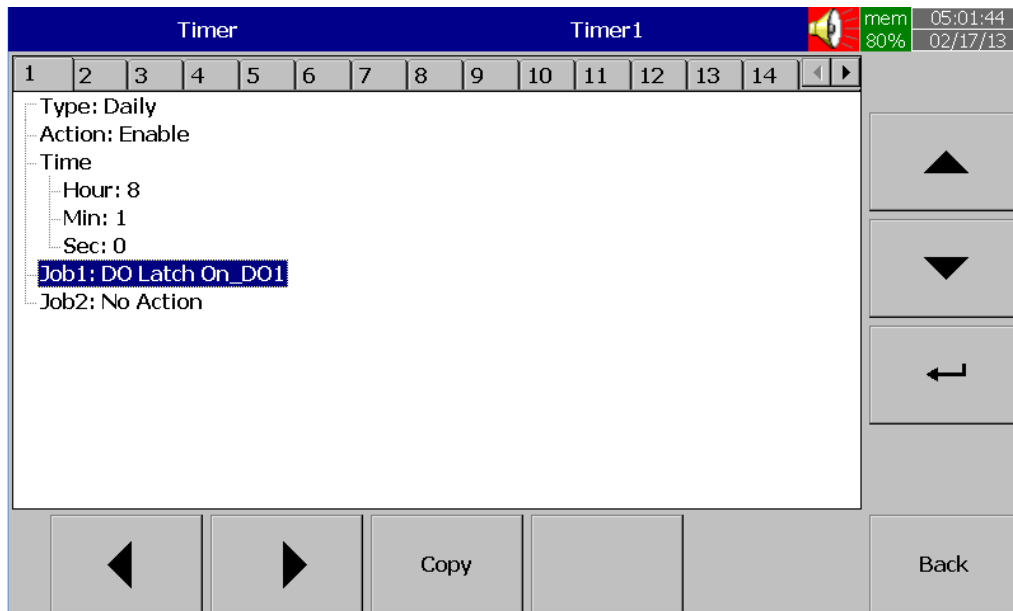

Fig: Status bar display in Real time

4.3 Timer

Path:  (Menu)-More-Config-Timer



Press directional keys $\langle \rangle$ at the bottom to select from one of 20 available timers.

Type: Countdown, Repeat Countdown, Daily, Weekly or Monthly.

Countdown: Defines the interval of time, e.g. days, hours, minutes and seconds.

(Not the Actual Time)

Repeat Countdown: Repeats the previous countdown (Not the Actual Time)

Daily, Weekly or Monthly: The timer works in selected interval of Real Time.

Action: Disables or enables the timer.

Job1, Job2: 2 jobs can be configured for each timer.

4.3.1.1 Timer Example-1

Switch on water pump every day at 8.00am and switch off at 10.00am

This application requires a “Daily” timer which works with Real Time Clock.

Configuration settings are as follows.

Timer1

Type: Daily Action: Enable
Time – Hour: 8 Min: 0 Sec: 0
Job1: DO Latch On, Target: DO1
Job2: No Action

Timer2

Type: Daily Action: Enable
Time – Hour: 10 Min: 0 Sec: 0
Job1: DO Latch Off, Target: DO1
Job2: No Action

4.3.1.2 Timer Example-2

Let’s say, when a digital input high event is triggered by high pressure, you would like to switch on a relay after a 10 seconds delay.

Digital Input1

Event1
Type: H
Job1: Enable Timer, Target: Timer1
Job2: No Action

Event2
 Type: L
 Job1: DO Latch Off, Target: DO1
 Job2: No Action

Timer1
 Type: Countdown, Action: Disable
 Time – Hour: 0 Min: 0 Sec: 10
 Job1: DO Latch On, Target: DO1
 Job2: No Action

4.3.1.3 Timer Example-3

Timer & Report:

A manager plans to get a **daily** report from the recorder about the **minimum, maximum and average** values of the process every day. After production has finished, he can press **Menu**, then **Event**, then he selects **Report** and presses the **Mode** key to select the **Daily** mode. He then is able to view the report like in the figure shown below

Timer1

Type: Daily Action: Enable
 Time – Hour: 17 Min: 01
 Job1: Log Report Target: ALL CH MinMaxAve
 Job2: Reset Min/Max/AveTarget: ALL CH
 (Reset historical data in order to logging new data for the next day.)

No	Type	Name	Value	Time
1	Channel	AI1	1000.0\120.0\441.9 °C	5:01:01 PM
2	Channel	AI2	1271.9\101.9\587.4 °C	5:01:01 PM
3	Channel	AI3	318.8\168.8\75.8 °C	5:01:01 PM
4	Channel	AI4	712.5\87.5\401.1 °C	5:01:01 PM
5	Channel	AI5	1365.0\455.0\911.6 °C	5:01:01 PM
6	Channel	AI6	1215.4\552.4\885.0 °C	5:01:01 PM
7	Channel	AI7	1104.9\662.9\884.7 °C	5:01:01 PM
8	Channel	AI8	621.9\428.1\525.3 °C	5:01:01 PM
9	Channel	AI9	1832.0\184.0\855.6 °F	5:01:01 PM
10	Channel	AI10	2321.4\151.4\1123.8 °F	5:01:01 PM
11	Channel	AI11	605.8\271.8\180.8 °F	5:01:01 PM
12	Channel	AI12	1314.5\189.5\769.7 °F	5:01:01 PM
13	Channel	AI13	2489.0\851.0\1695.7 °F	5:01:01 PM
14	Channel	AI14	2219.6\1026.4\1641.7 °F	5:01:01 PM
15	Channel	AI15	2020.8\1225.3\1635.5 °F	5:01:01 PM
16	Channel	AI16	1353.9\960.1\1163.2 °F	5:01:01 PM

4.4 Clock

Path:  (Menu)-More-Config-Clock

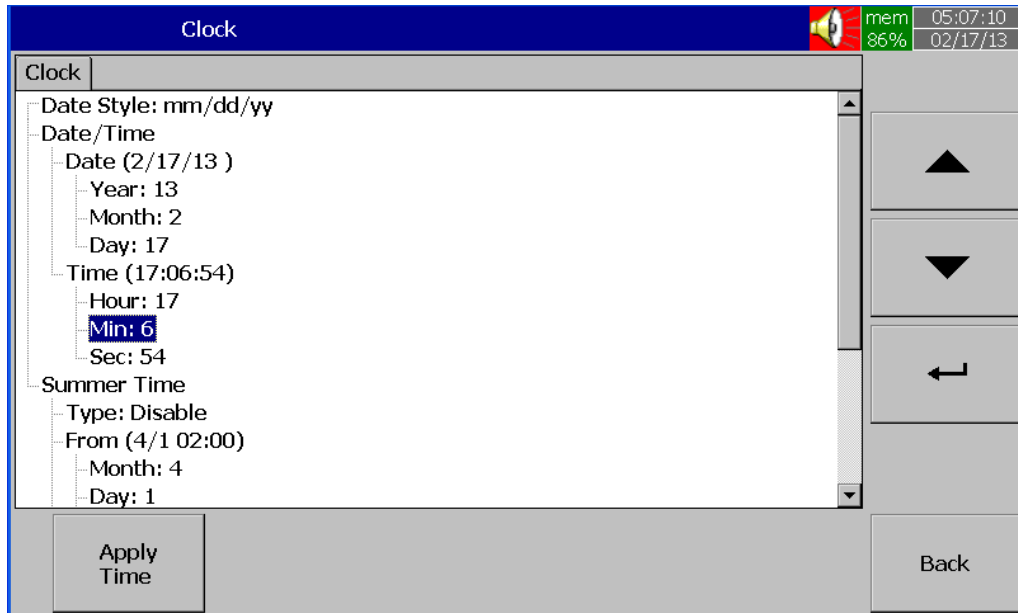

Fig: Clock configuration page in Paperless Recorder

Date Style: Selects either month/date/year or date/month/year

Date/Time: Set up the local time. Use directional keys Up/Down to select the column, press “Enter” soft button to change the clock data. Then press the “Apply Time” Soft button to apply it to the recorder.

Summer time: In some countries of North America and Europe, clocks are adjusted forward one hour near the start of spring and are adjusted backward in autumn. This is commonly referred to as Daylight Savings Time. We refer to this as “Summer Time”. A Summer time set provision is available in the paperless recorder. In **Summer time**, Select **Type:** Enable and then set Start (Month, Day, Hour, Min) and End (Month, Day, Hour, Min) details.

4.5 Communication

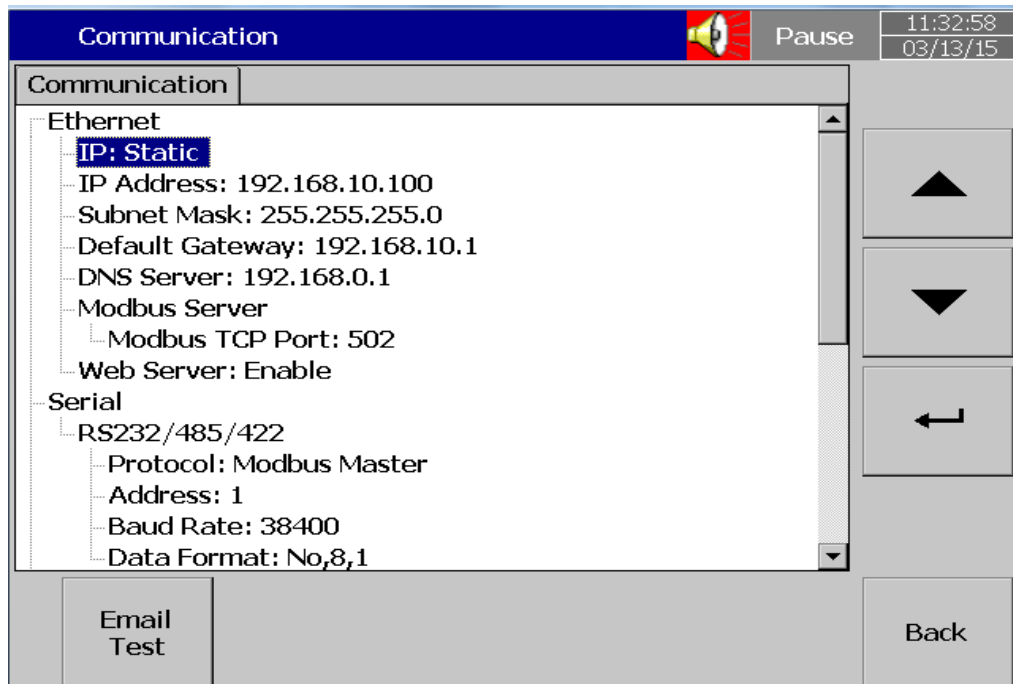

Ethernet

IP: DHCP/STATIC

Select **DHCP** if the server on the network automatically allocates the IP address for the recorder.

Select **STATIC** to manually set a fixed address for the recorder.

IP Address: Defines the current address of the recorder on the network

Subnet Mask: Defines the current **Subnet Mask** address on the network

Default Gateway: Defines the current Gateway address.

DNS Server: This is required if the recorder is to be connected to Internet

Modbus Server: When configured as Slave Recorder is act as Server in Modbus Connectivity

Modbus TCP Port: Default: 502 for Modbus TCP

Serial:

Protocol: Modbus RTU Master/ Modbus RTU Slave
Address: Address of Master/Slave in the network
Baud rate: 9600/14400/19200/38400/57600/115200
Data format: None, 8, 1 or Odd, 8, 1 or Even, 8, 1

Modbus Client/Master:

Sample Rate:

Ethernet: 100 msec/dot, 1 sec/dot, 2 sec/Dot, 5 sec/dot, 10 sec/dot
Timeout : The default timeout is 100ms
Serial: 100 msec/dot, 1 sec/dot, 2 sec/Dot, 5 sec/dot, 10 sec/dot
Timeout : The default timeout is 100ms
Interval between 2 commands : The default timeout is 10ms

Email: Enable/Disable

The settings for sending through gmail are as below. The user can also send email after a scheduled time

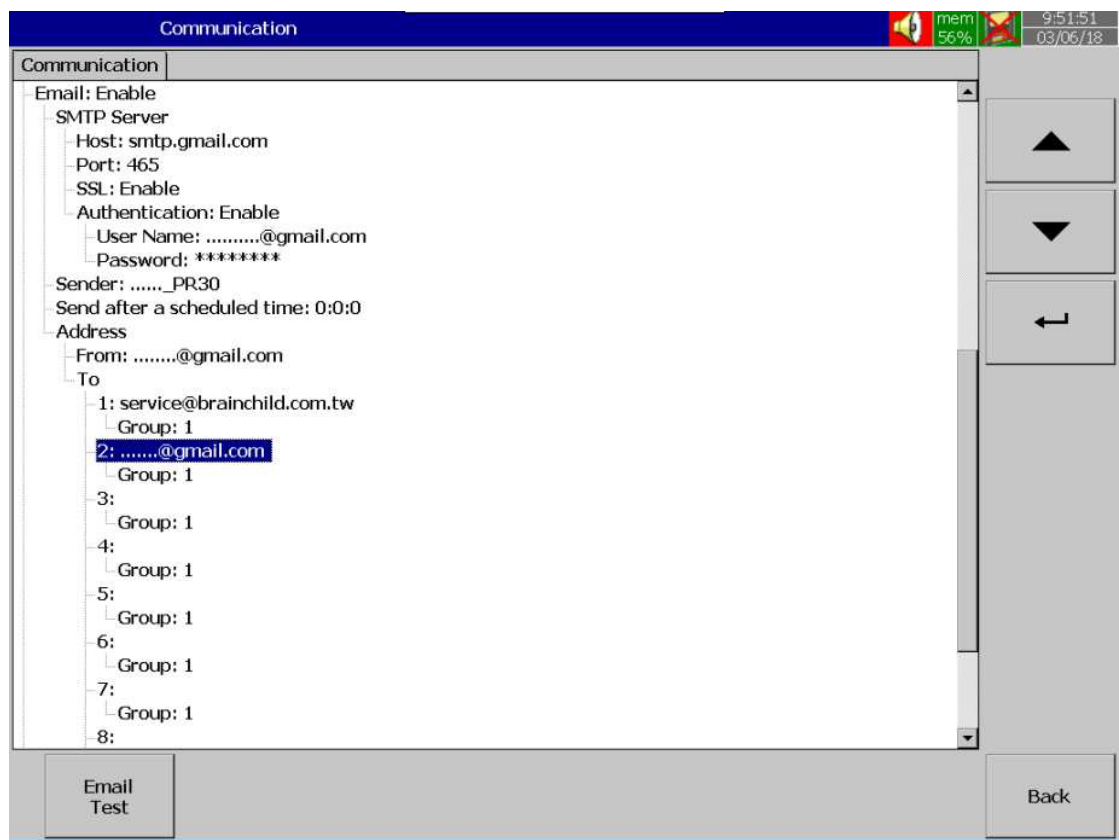

Press' "Email Test" and check mail function

If any problems with Email delivery, it will show error as shown below

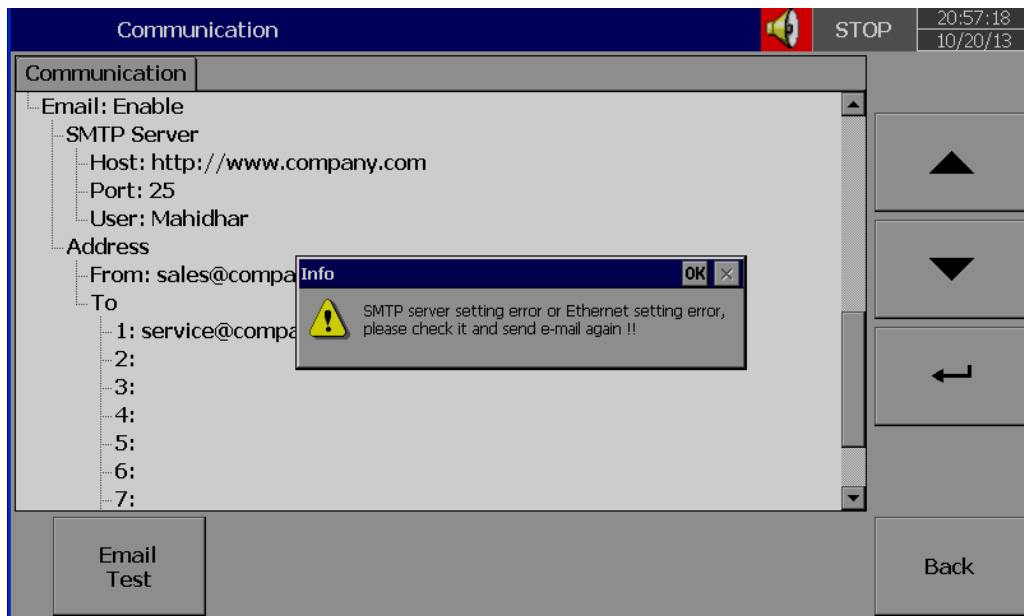

4.5.1 Connections

There are a total of 16 connections available

Each connection can be configured as either Serial or Ethernet

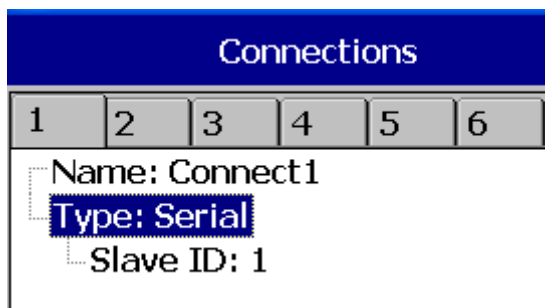

Name: Connection name

Type: Serial/Ethernet

Slave ID: If Recorder is Modbus RTU Master, then, all the Slaves need to be configured in the connections.

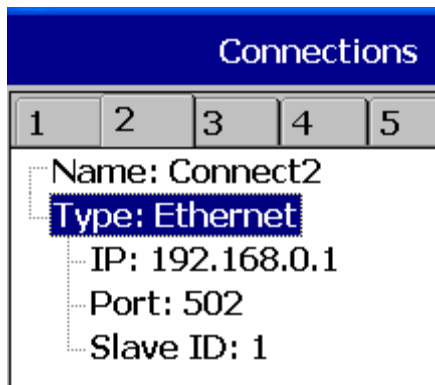

IP: This is enabled only if Type = Ethernet selected at any connection

4.5.2 Commands

A total of 16 commands are available

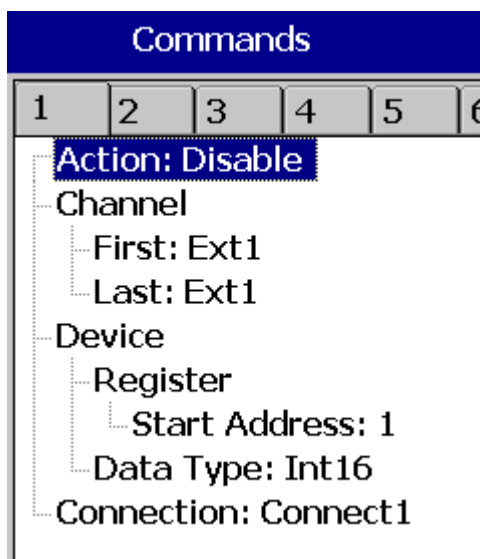

Action: Enable/Disable

To Channel:

First: Enter first external channel details, Ex : Ext1

Last: Enter last external channel details, Ex: Ext24

From Device

Register:

Start: Address: Enter Start register address

Data Type: Int16/UInt16/Int32_B/Int32_L, UInt32_B, UInt32_L, Float_B, Float_L

Connection: Select the required connection

4.5.3 Modbus RTU Master, Example1

Master: Paperless Recorder

Slaves: External IO modules, 2 nos. each with 8 channel Analog inputs

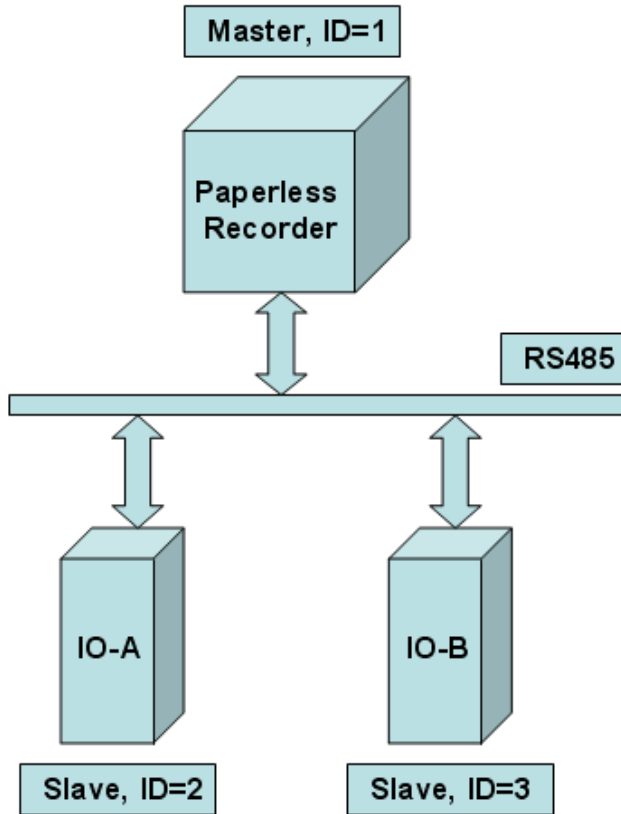

Modbus Address	Register Name	Low Limit	High Limit	Access
30002	Analog Input 1	0	4095	R
30003	Analog Input 2	0	4095	R
30004	Analog Input 3	0	4095	R
30005	Analog Input 4	0	4095	R
30006	Analog Input 5	0	4095	R
30007	Analog Input 6	0	4095	R
30008	Analog Input 7	0	4095	R
30009	Analog Input 8	0	4095	R

Fig: External IO modules Register table

Master Configuration

Serial

- RS232/485
 - Protocol: Modbus Master
 - Address: 1
 - Baud Rate: 38400
 - Data Format: No,8,1

Slave Configuration

Connections					
1	2	3	4	5	6
Name: Connect1					
Type: Serial					
Slave ID: 2					

Connections					
1	2	3	4	5	6
Name: Connect2					
Type: Serial					
Slave ID: 3					

Commands					
1	2	3	4	5	6
Action: Enable					
To Channel					
First: Ext1					
Last: Ext8					
From Device					
Register					
Type: Input					
Start Address: 2					
Data Type: Int16					
Connection: Connect1					

Commands					
1	2	3	4	5	6
Action: Enable					
To Channel					
First: Ext9					
Last: Ext16					
From Device					
Register					
Type: Input					
Start Address: 2					
Data Type: Int16					
Connection: Connect2					

4.5.4 Modbus RTU Master, Example2

Master: Paperless Recorder

Slave: PID Controller

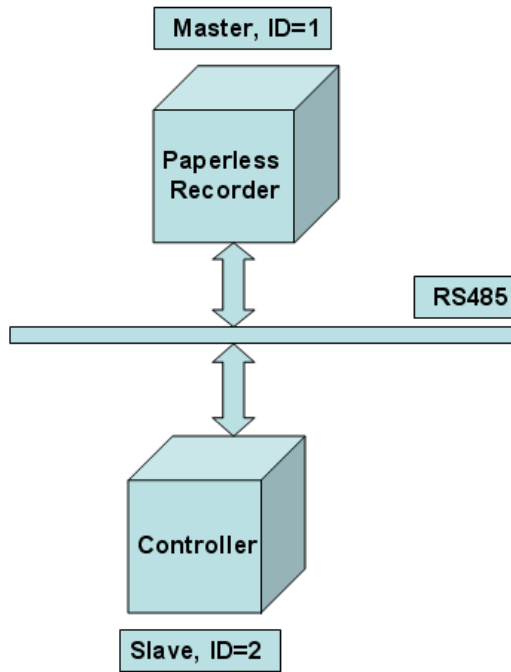

Register Address	Parameter Notation	Parameter Description	Range	Default Value	Data type
128	PV	Process value	Low: -32768 High: 32767	—	R
129	SV	Set point value for control	Low: SPLO High: SPHI	—	R

Fig: External PID Controller Register table

Master Configuration

- Serial
 - RS232/485
 - Protocol: Modbus Master
 - Address: 1
 - Baud Rate: 9600
 - Data Format: No,8,1

Slave Configuration

Connections					
1	2	3	4	5	6
Name: Connect1					
Type: Serial					
Slave ID: 2					

Commands						
1	2	3	4	5	6	7
Action: Enable						
To Channel						
First: Ext1						
Last: Ext2						
From Device						
Register						
Type: Input						
Start Address: 129						
Data Type: Int16						
Connection: Connect1						

Name Desc

Type

Log

Data Type Value Range: -32768 ~ 32767

Trigger Method

Speed

Modbus Register Value Conversion

Data Type Modbus Scale: 0 ~ 65535

Formula: $A = ((M - ML) / (MH - ML)) * (AH - AL) + AL$ $M = ((A - AL) / (AH - AL)) * (MH - ML) + ML$

Modbus Register Value(M) Range

Low(ML) High(MH) ← Check slave modbus register scaling

Actual Value(A) Range

Unit

Low(AL) High(AH) ← Actual value scaling corresponding to slave register

For the above, if the slave register is 16 bit , then Modbus scaling would be from 0-65535 and we are scaling Temperature 0-1000,so actual scaling would be 0-1000.

4.5.5 Modbus RTU Slave, Example

Master: PC, Modbus RTU OPC Server

Slaves: Paperless Recorders, 2 nos. each with 6 channel Analog inputs

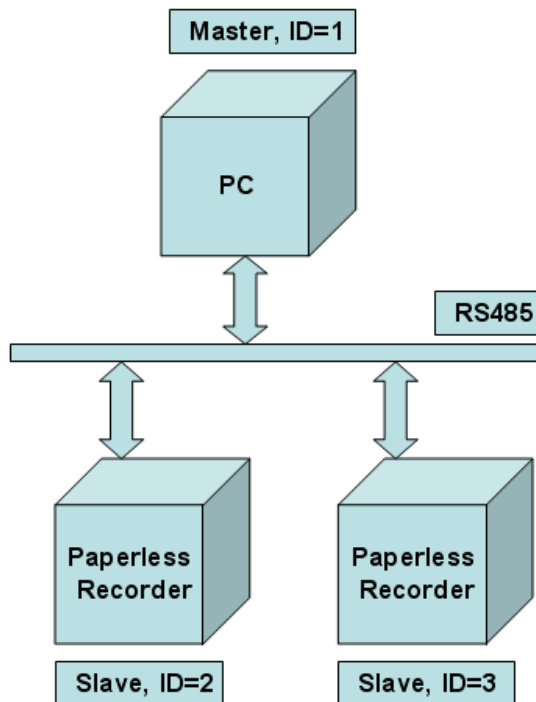

1. Input Register Parameter Table

Address	Notation	Parameter	Scale Low	Scale High	Notes
0	AI1PV	AI1 process value	*1	*1	R
1	AI2PV	AI2 process value	*1	*1	R
2	AI3PV	AI3 process value	*1	*1	R
3	AI4PV	AI4 process value	*1	*1	R
4	AI5PV	AI5 process value	*1	*1	R
5	AI6PV	AI6 process value	*1	*1	R
6	AI7PV	AI7 process value	*1	*1	R

*1: The scale high/low value are define in the following table for

Conditions	DP=0	DP=1	DP=2	DP=3	DP=4	DP=5
Scale low	-19999	-1999.9	-199.99	-19.999	-1.9999	-0.19999
Scale high	45536	4553.6	455.36	45.536	4.5536	0.45536

Fig: Paperless Recorder (Slave) Register table and scaling information

```

Serial
├── RS232/485
│   ├── Protocol: Modbus Slave
│   ├── Address: 2
│   ├── Baud Rate: 38400
│   └── Data Format: No,8,1
    
```

4.6 Instrument

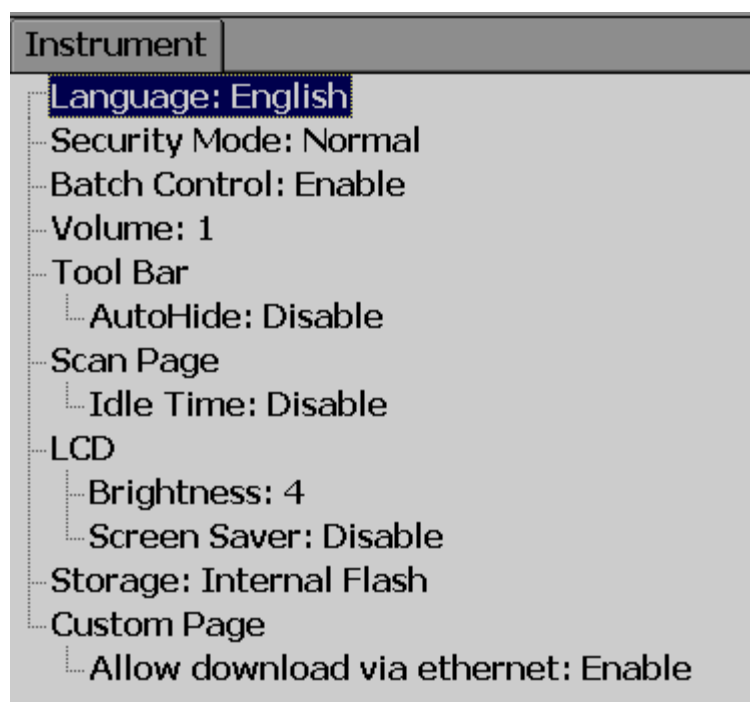

Language: A total of 20 languages are supported. They include English, Simplified Chinese, Traditional Chinese, Japanese, Korean, French, German, Italian, Polish, Spanish, Portuguese, Brazil Portuguese, Russian, Thai, Czech, Danish, Dutch, Swedish, Turkish & Greek.

Security: Select Normal or CFR-21 security. More details available at section "Security"

Batch Control: Disable and Enable options available for the selection. Refer section "Batch Control" for more details.

Volume: When the screen is touched, you can hear a "beep" sound. Select Disable to switch off the beeper. Select value 1 to 10 for volume control. 1 is minimum sound and 10 for maximum sound

Tool bar: On left side of the display page, the tool bar appears for configuration.
Auto Hide: Select 10 Sec or 20 Sec or 30 Sec or 60 Sec to hide the tool bar if the user does not operate recorder via touch screen for the set time interval. Select "disable" if auto-hide is not required on specific set time

Scan Page: The User can set Automatic scanning of display pages for fixed time when enabled . The Fixed times are 1minute to 10 minutes.

Idle time: If touch screen is not used for the set idle time, then the display pages will start scrolling as per defined scan rate. Select 1 to 10 Min. for the idle time if display scroll feature is required, otherwise select "disable".

Scan Rate: This is the scroll time for the display pages. Select a time interval between 5 sec to 30 sec. This time interval is effective only if the “idle time” is enabled and the selected time is between 1 to 10 min

LCD:

Brightness: Select level between 0 and 6. 0 is the lowest brightness and 6 is for the highest possible brightness

Screensaver: To prolong the life of the LCD display, it is suggested to set the display turn-off time to 1, 10, 20, 30, 40, 50 or 60 minutes after the last time the user operates the recorder. ***Screensaver default time is set to 10minutes from the factory.*** The recorder continues to record data while it is in screen saving mode. The display turns on again by touching the LCD screen

Storage: Select internal flash memory or SD card

Custom page: User can use this setting to enable or disable custom pages downloaded via Ethernet.

Allow download via Ethernet: Enable/disable

4.7 Security

4.7.1 Normal

Path:  (Menu)-More-Config-select Instrument, then press “Enter”

Select “Security” = Normal

If normal security is selected, users will need to key in a common password with a maximum of 18 characters. Once the password has been entered, the user needs to key in the password whenever **Config, Dump, Clear** or **Operate** soft keys are required. These keys enable the user to do configuration, dump data, clear data or manually operate the job. For easy access **Config, Dump, Clear** or **Operate** soft keys, the user may ignore the password by leaving the password field blank. If a password is not entered initially, there is no password required.

How to enter simple password

 (Menu)-More-Config, select Password, press “Enter”, then key-in the passwor

4.7.2 CFR-21

If the higher security CFR-21 is selected, it requires the recorder to operate with more restricted rules which comply with **FDA 21 CFR Part 11**

It has time limit during operation. If the user does not press any keys in a predefined period of time (which can be selected between 1 to 20 minutes using LogOut function), the user needs to key in the password again. It also offers an audit trail function to record the user, the timing, and what type of work the user was doing on the recorder. Incorrect password and unauthorized operation will be recorded into the event list as well. The maximum number of users available in FDA 21 CFR Part 11 Security Mode is 30.

In  (Menu)-More-Config-Select **Instrument**, press "Enter" soft button.

Select Security = CFR-21.

Security Mode: CFR-21

- Logout: Disable
- Password validity: Unlimited
- Security Level of Functions
 - Login From PC: 9
 - Dump: 9
 - Clear: 9
 - Operate: 9
 - Config: 9
 - Pause: 9
 - ShutDown: 9

LogOut: Time selection available from 1 min. to 20 min. This selection is visible only if CFR-21 is selected

If no user operates the Paperless Recorder for the above set duration, the current user will be logged out automatically

Password validity:

Password validity can be set for 30, 60 or 90 days. After the preset amount of days, it will require the user to key in a new password, or keep the old one for an additional 30, 60 or 90 days.

Security levels:

0 to 9 levels are supported

9 is the highest authority level, 0 is the lowest

4.8 Demo

The Demo mode is a simulation mode used as a sales tool for demonstration purposes. It is set to simulate AI analog inputs and Math functions.

*To start the automatic demonstration, first enable **Demo mode**, then turn the power OFF and Power ON to make it effective. To stop the automatic demonstration and return to real mode with real inputs, first disable Demo mode, then turn the power off and Power ON.*

4.9 Auto-Output

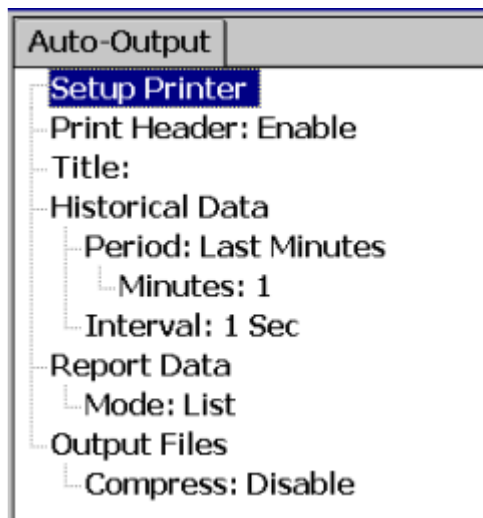

Setup Printer: It is to configure printer

Select **Setup Printer** and then press the "Enter" soft button

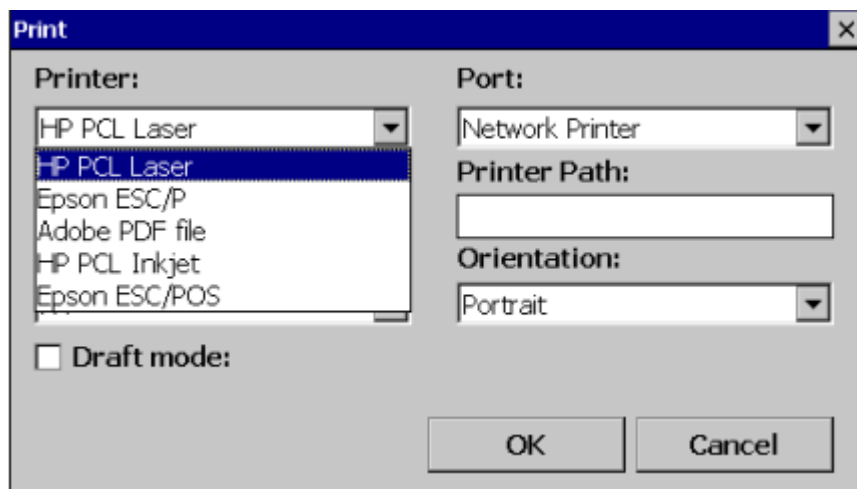

Five kinds of printers are supported. One is USB printer for page printing , another is Serial printer for Line printing and we also have Adobe PDF file printing

Print Header: The user can enable or disable the print header

Title: Title for Print

Applications: Print Historical data, events, & Reports and snapshot directly from Paperless Recorder.

4.9.1 USB Printer

Generally, USB printer support PCL protocol. It means, it will support Page Print, but not line print. We support PCL language 4, 5 & 6

If USB printer supports ESCP protocol similar to EPSON LQ300+, then, it is possible to take line print.

Please refer Printer user manual for exact protocol details



Do not use USB printer supporting only PCL to print single line alarms, otherwise, pages will be wasted

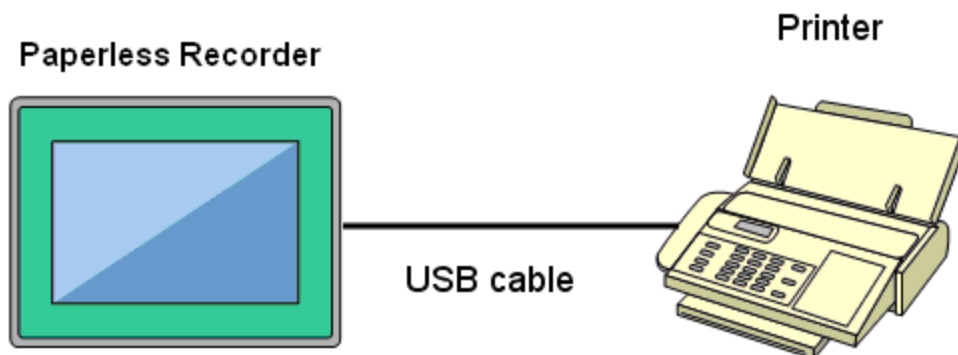

Procedure

Connect Recorder to Printer via USB cable

Power ON Printer

Path:  (Menu)-More-Config-Auto-Print, Enter

Select "Setup Printer", press "Enter" soft button

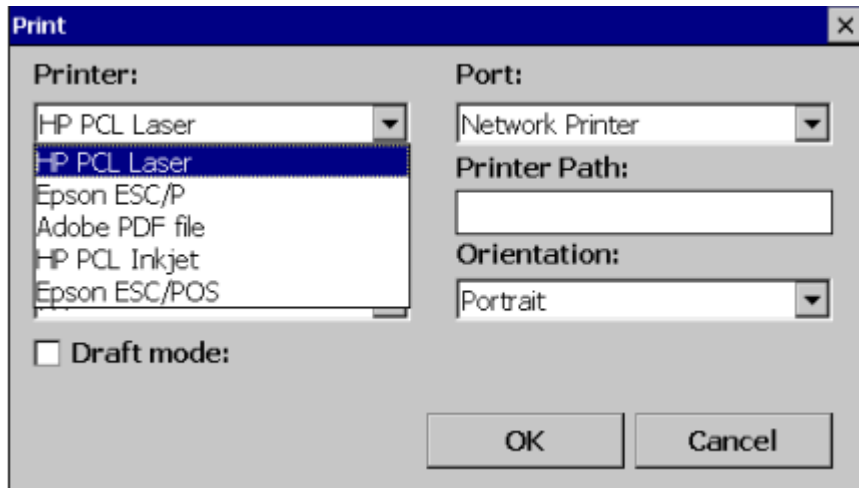

Printer: HP PCL Laser, ESCP printer, PCL Inkjet, Epson ESC/POS and Adobe PDF file available by default. Select one from the list as per printer model connected to the Paperless Recorder

Port: It shows “Network” by default. Once a printer is connected to the USB port, it will show “LPT1” for the USB printer. Select “LPT1”

Net Path: It is required to enter the correct network path here only if both Printer and Paperless Recorder are connected to a LAN network

Paper Size: A4, B5, Legal and Letter are supported

Draft mode: By default, it is selected. If more quality print is required, deselect Draft Mode

Color: Enabled for Inkjet printer

Orientation: Select Portrait/Landscape as per requirements

Note: Margins & Print Range are not working at this time.

Now, setup is ready at Paperless Recorder

4.9.2 Network Printer (LPT1)

Serial printer will print minimum one line and is generally used for printing Real time alarms. Also, it can be used for printing historical data and alarms from the Paperless

Recorder. ESCP language id supported, so any printer supporting ESCP like LQ300+ can be used. The LPT1 port of a PC can be connected to a Serial printer directly. However, it needs to have a Printer driver installed in PC first, and share it for network use via Ethernet.

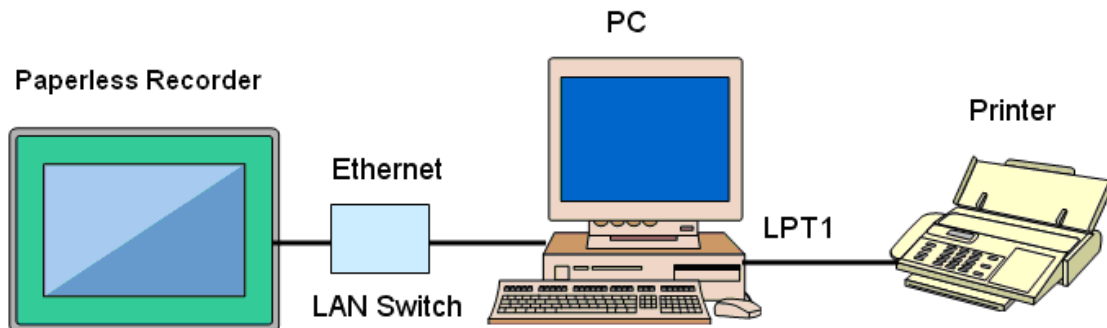

Procedure

Connect Paperless Recorder to PC via Ethernet

Install Printer driver in PC. Share Printer for network use

Connect Printer to PC via LPT1

Power ON Printer

In Paperless Recorder, at Path, select (Menu)-More-Config-Auto-Print, Enter

Select "Setup Printer", press "Enter" soft button

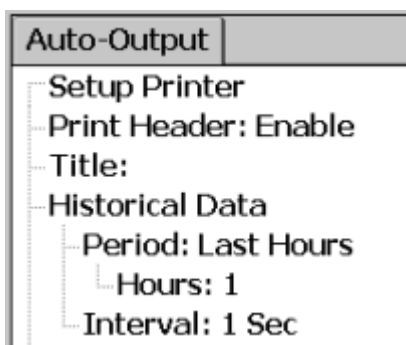

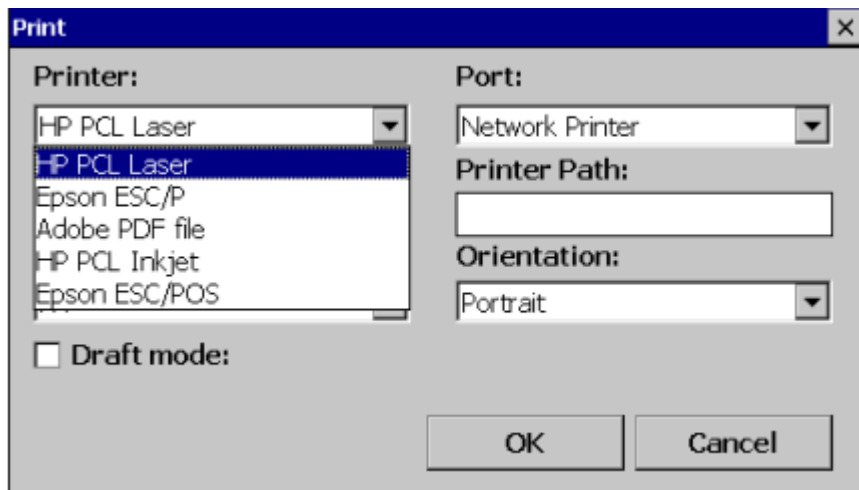
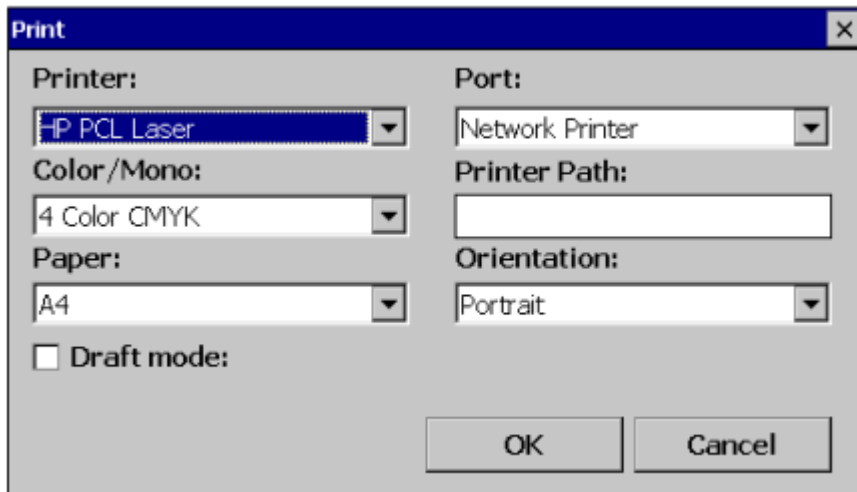

Select ESCP printer.

Then, enter the proper Net Path. Ex: \\PC1\LQ300

PC1 is computer name and LQ300 is shared printer driver for network use

Now, the setup is ready at the Paperless Recorder

4.9.3 Print Historical data

Configure USB Printer or Network printer as explained in earlier section

In Paperless Recorder, at Path, select  (Menu) -More-Config-Auto-Output, Enter

Auto-Output
Setup Printer
Print Header: Enable
Title:
Historical Data
Period: Last Hours
Hours: 1
Interval: 1 Sec

Period: Select Last hours or Last days

Hours/Days: Select no. of hours or no. of days as per above selection

Interval: Select intervals of 100 msec/1 sec/2 sec/ 5sec/ 10 sec/ 20 sec/ 30 sec/ 1 min/ 5 min/ 10 min.

The Print function is available in the Job list and can be initiated in various ways.

Ex: Print historical data of last 1 hr. and do this every day at 8.00 hrs

Timer					
1	2	3	4	5	6
Type: Daily					
Action: Enable					
Time					
Hour: 8					
Min: 0					
Sec: 1					
Job1: Print Historical Data					
Job2: No Action					

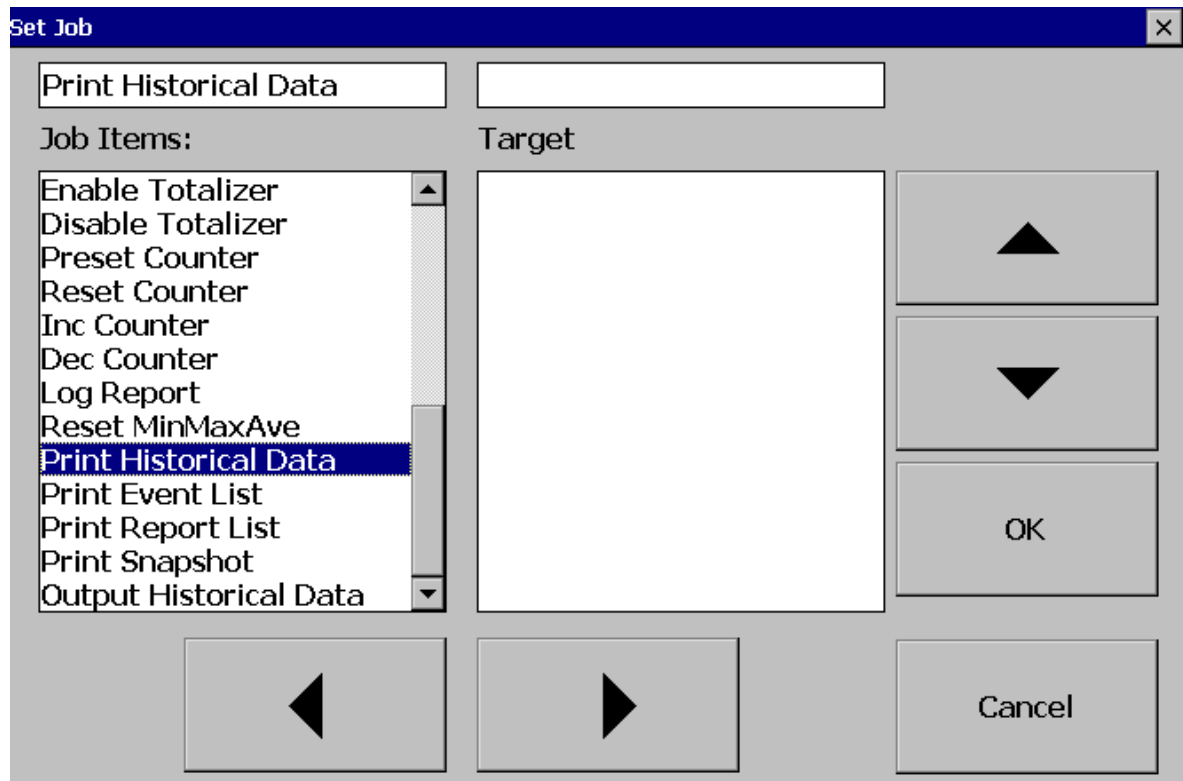

4.9.4 Print Reports

In Paperless Recorder, at Path, select  (Menu)-More-Config-Auto-Output, Enter

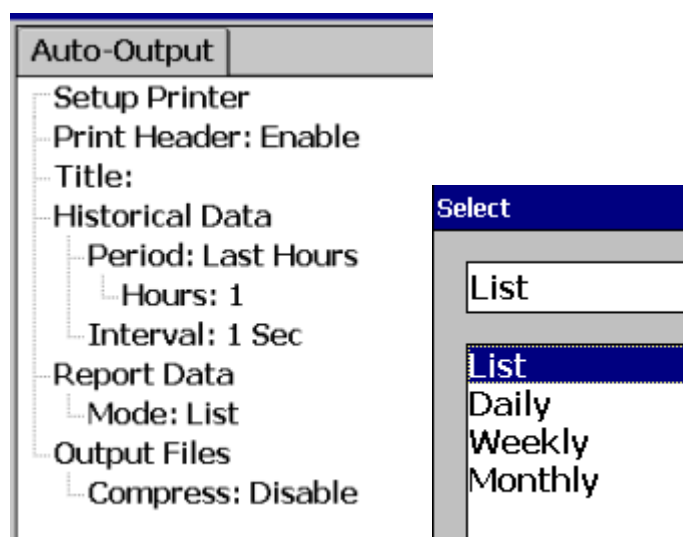

In the **Mode**, select which kind of Reports are required. Available options include Daily Reports, Weekly Reports and Monthly Reports

Timer					
1	2	3	4	5	6
Type: Daily					
Action: Enable					
Time					
Hour: 8					
Min: 0					
Sec: 1					
Job1: Print Report List					
Job2: No Action					

4.9.5 Print Snapshot

 (Menu)-More-Operate-Print Snapshot

Menu	
Realtime	
Mode	Dump
Alarm	Clear
Status	Operate
History	Config
Event	Stop
More	ShutDown

Operate x

Print Snapshot

Job Items:

- Enable Totalizer
- Disable Totalizer
- Preset Counter
- Reset Counter
- Inc Counter
- Dec Counter
- Log Report
- Reset MinMaxAve
- Print Historical Data
- Print Event List
- Print Report List
- Print Snapshot
- Output Historical Data

Target

▲

▼

OK

◀

▶

Cancel

4.10 System Info

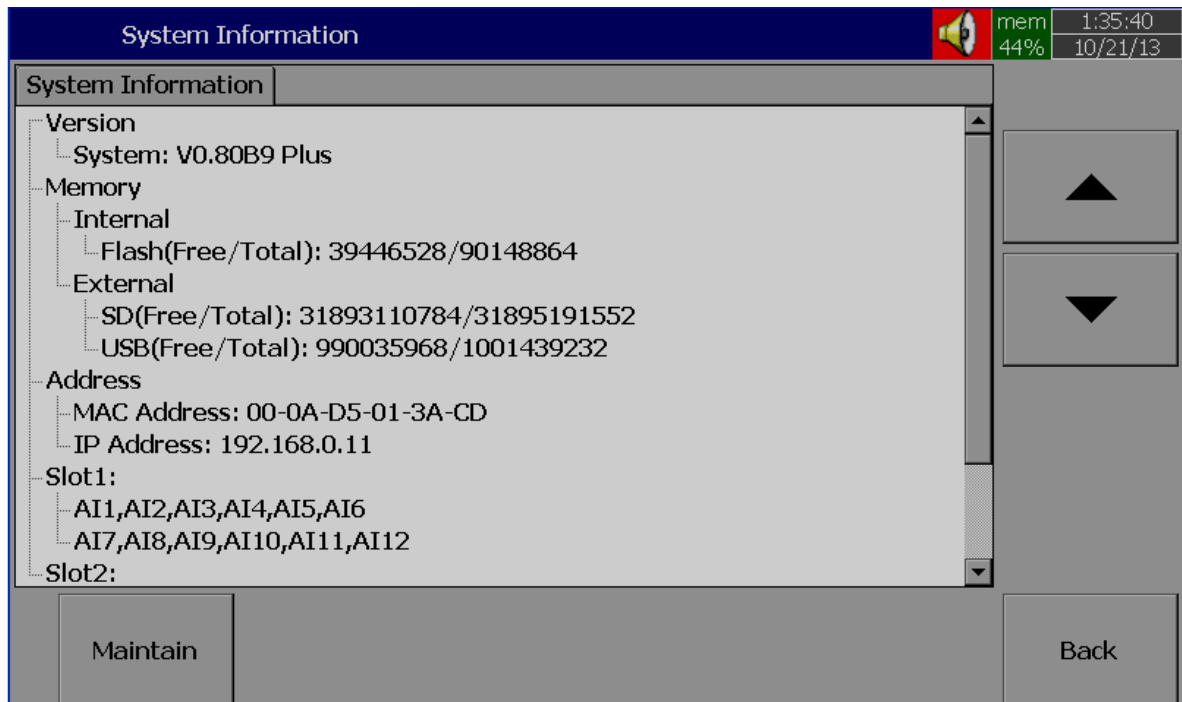

Path:  (Menu)-More-Config-System Information

The system information includes System version, Internal and External memory, Ethernet IP address and Slots status

Version: The firmware version of the recorder.

Memory (Free / Total):

Internal: Indicates the percentage of free memory compared to total memory available in internal flash card

External: Indicates the percentage of free memory compared to total memory available in external memory devices of SD and USB.

A small icon on the top right indicates the percentage of free memory e.g.: Mem 96 %

Address:

MAC: Displays the MAC address of Paperless Recorder

IP address: Displays the IP address for the Paperless Recorder

Slot 1..5: Indicates the status of all Slots and the cards that have been inserted. The cards include Analog Input AI, Digital Input DI and Digital Output DO & AO.

4.10.1.1 Upgrade Firmware

Path:  (Menu)-More-Config-System Information-Maintain

Maintain: The Maintain button is located at left lower side in System Info. page. It is the button to upgrade the firmware and calibrate the touch screen in the paperless recorder

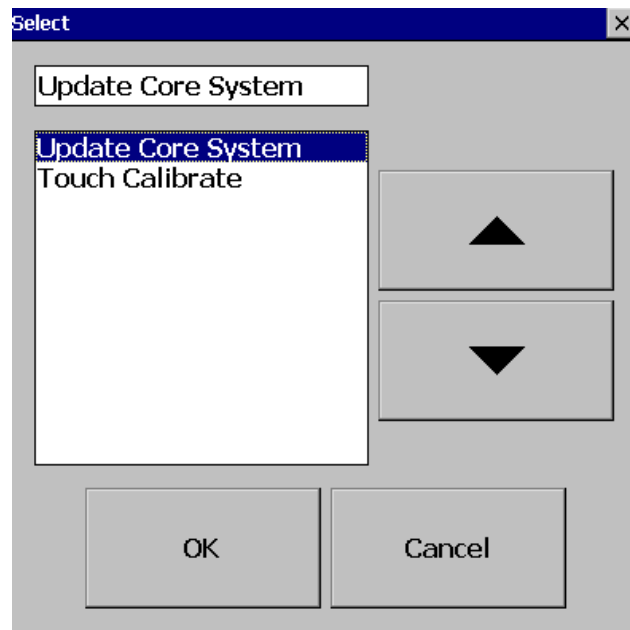

Upgrade Core System:

This is to upgrade firmware in the paperless recorder. Contact factory/supplier for the latest firmware files. Please download firmware file (.bin file, its compressed , it needs to be un zipped) to a USB stick or SD Card then, insert the USB stick into USB port or SD Card at SD card Slot in the Paperless Recorder. Select the External Storage to SD Card or USB flash on the External Storage Setting depends on the storage inserted. Select “Update Core System”, then click the “OK” button. It may take a few seconds to finish the process. Please note that the power to the recorder should be not switched off during this upgrade process

4.10.1.2 Calibrate Touch Screen

Path:  (Menu)-More-Config-System Information-Maintain

Maintain: The Maintain button is located at left lower side in System Info. page. It is the button to upgrade the firmware and Calibrate touch screen in paperless recorder

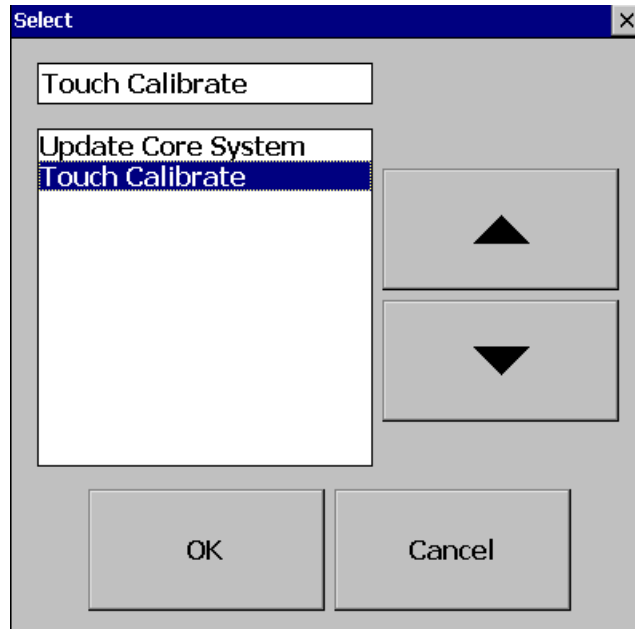

This is used to calibrate the touch screen. A “+” symbol appears in the center of the LCD screen. Carefully press and briefly hold a stylus or finger on the center of the target. Repeat this procedure as the target moves around the screen. Just touch the screen to complete the screen calibration. This procedure helps to locate pointer via touch screen and properly select the objects during operation of the recorder

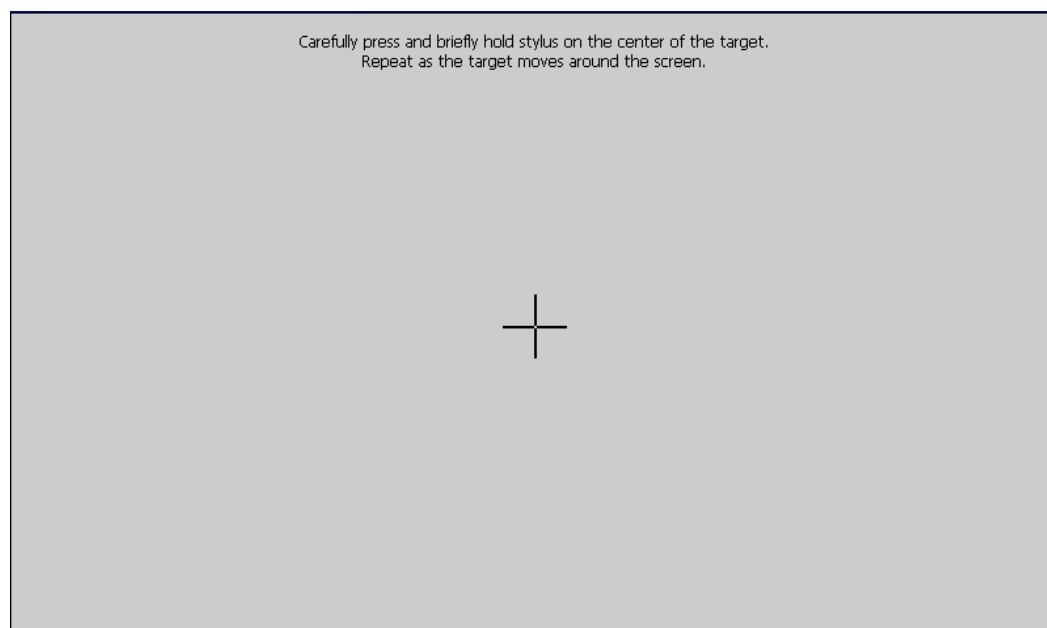

4.11 Batch Control

This feature is to store data in a different folder for every batch and archive data later with reference to a batch.

Path:  (Menu) - More-Config- Instrument

Select Batch Control and press “Enter” key. Select “Enable”. Press “OK”

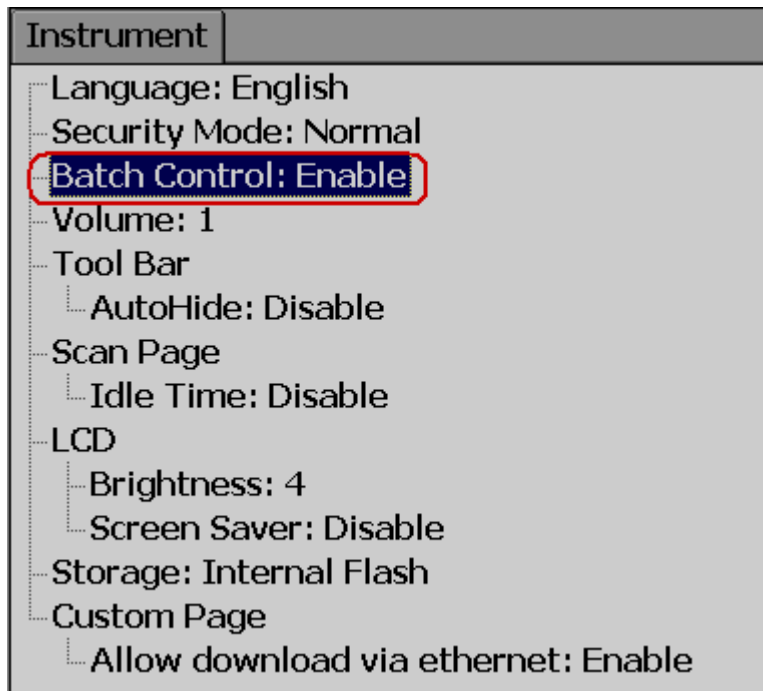

Press “Back”

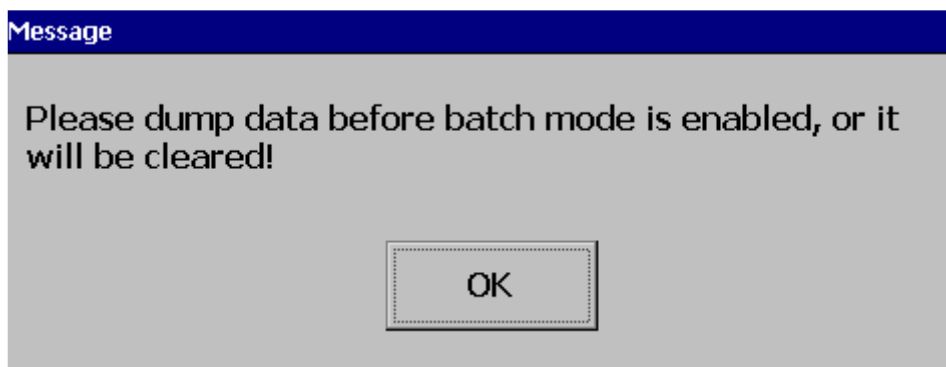



Press "OK", then, press "Home" Soft key to save these settings

Power the recorder OFF then ON, then in the  (Menu), the Batch soft key will be shown as below

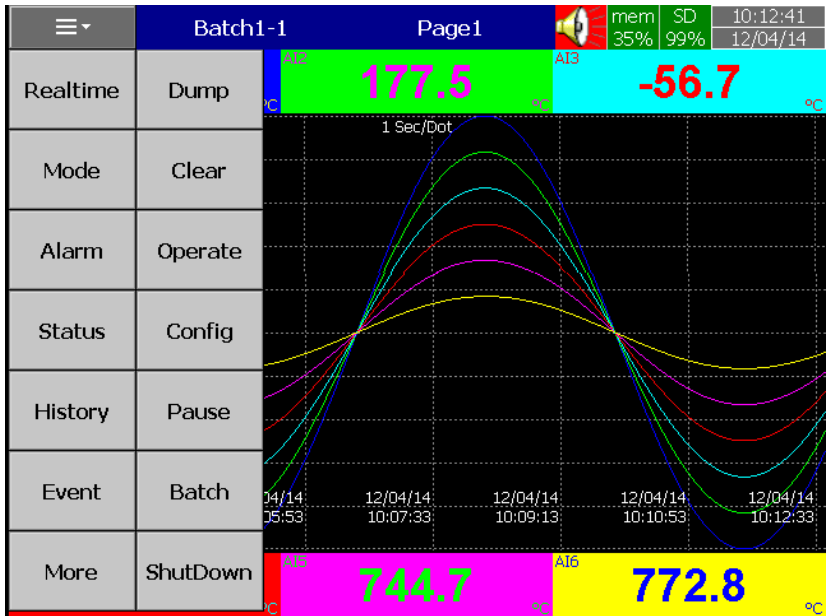

Note: "Batch" soft key will appear only after Batch Control enabled as explained above

Press on Batch and it shows the following screen

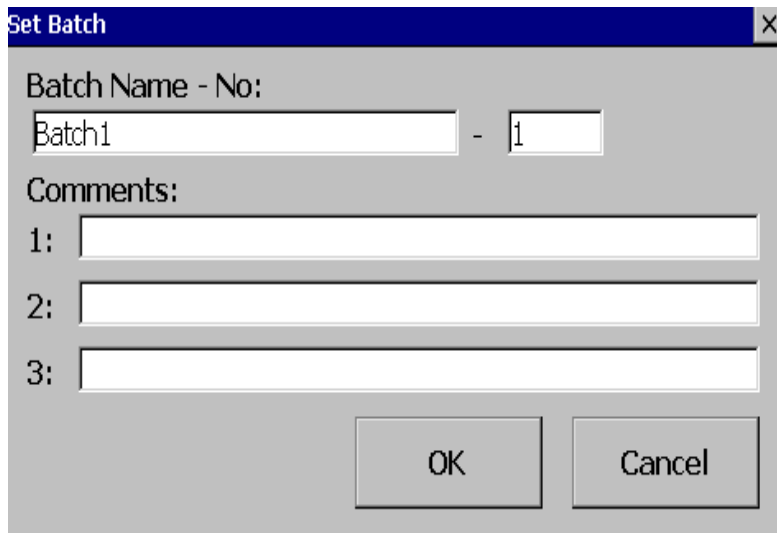

Set Batch [X]

Batch Name - No:
 -

Comments:
 1:
 2:
 3:

OK Cancel

Operator can enter a maximum of three comments for any batch.

In the  (Menu)-More-Config, select “Batch”, press “Enter” key

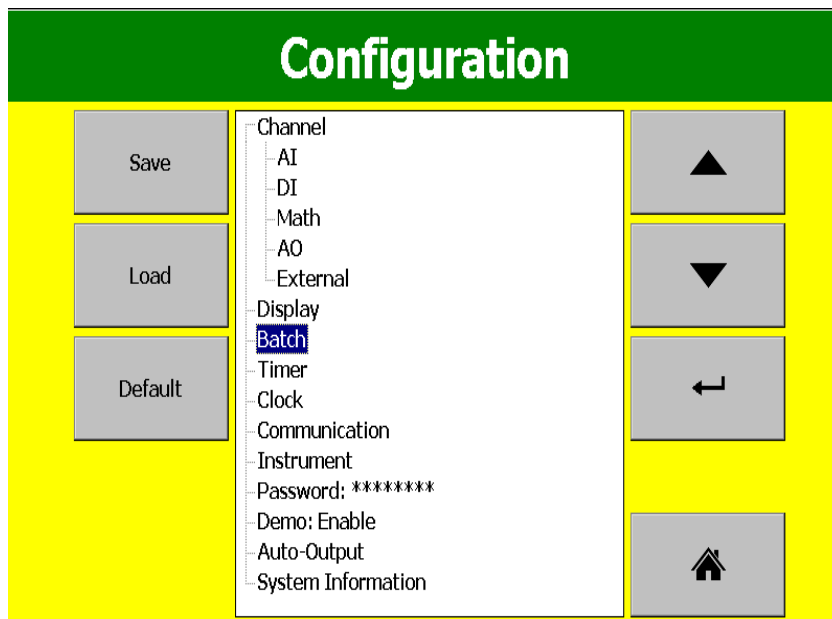

It will show the Batch control settings as shown below

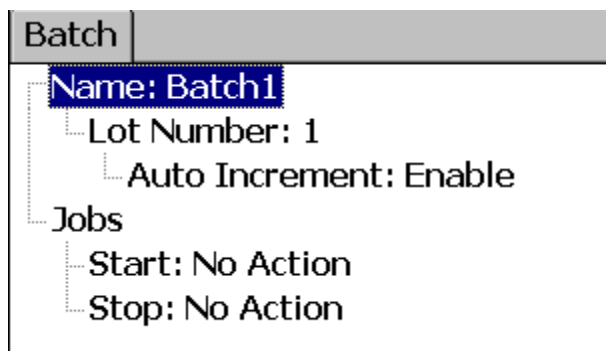

Batch

Name: Batch1

- Lot Number: 1
 - Auto Increment: Enable
- Jobs
 - Start: No Action
 - Stop: No Action

Name: Enter Batch name. A maximum of 18 characters is allowed. By default, the name is Batch1.

Lot Number: Enter the Lot number. If Auto increment is enabled, then Lot numbers will be incremented automatically by the recorder, Batch1-1, Batch1-2, Batch1-3 etc. during every start of a new batch

Jobs: Two events, Start, Stop are available

Start: Start means Jobs that should be done during start of a new batch

Stop: Stop means Jobs that should be done during stop of a batch

Note: When batch control is enabled, the recorder will be in Pause mode by default initially and it requires Starting of the recorder from the Menu by pressing at  (Menu) - More than “Start”. When recorder is not logging any data, Pause status shall be shown in the Top right area of the recorder as shown below



How to do the batch control

Press on  (“Menu”), “More”, then “Start”. Batch number will be shown in the recorder Top area.

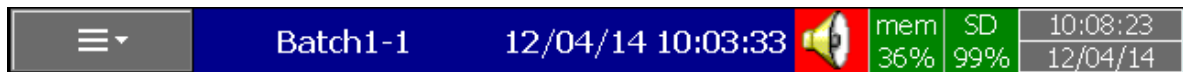

To Stop this batch, press on “Menu”, “More”, then “Pause”. It gives a message “Saving data” and updates batch data in the internal memory of the paperless recorder.

4.11.1.1 Batch Example-1

The operator wants to start a batch every day at 8.00am and stop the batch at 12.00am.

Configuration

Timer1

Type: Daily	Action: Enable
Time – Hour: 8	Min: 0 Sec: 1
Job1: Start	
Job2: No Action	

Timer2

Type: Daily Action: Enable
Time – Hour: 12 Min: 0 Sec: 1
Job1: Pause
Job2: No Action

How to view batch data in Recorder

Press on  (Menu)-History-Page1

Press “Search”, select required Batch and press “Ok”

Batch details including lot number can be archived by pressing soft key “Batch”

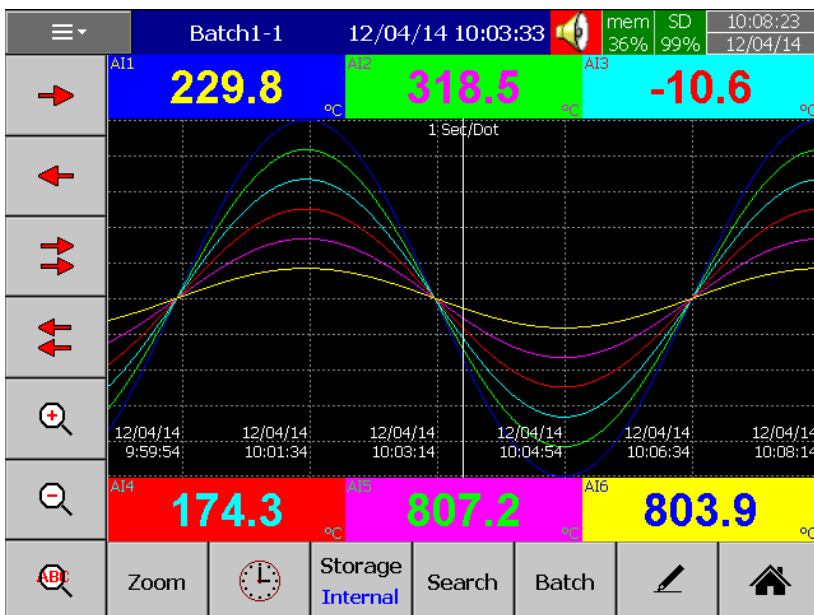
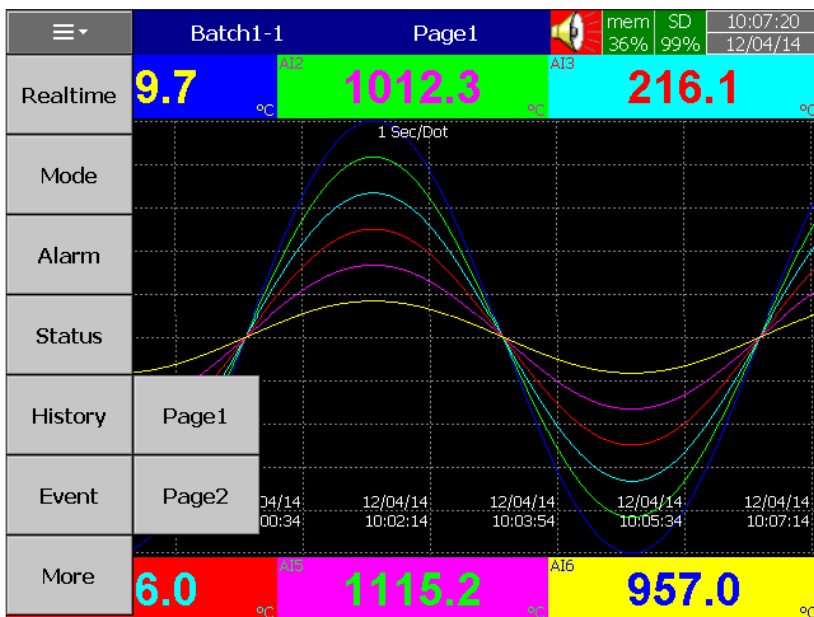

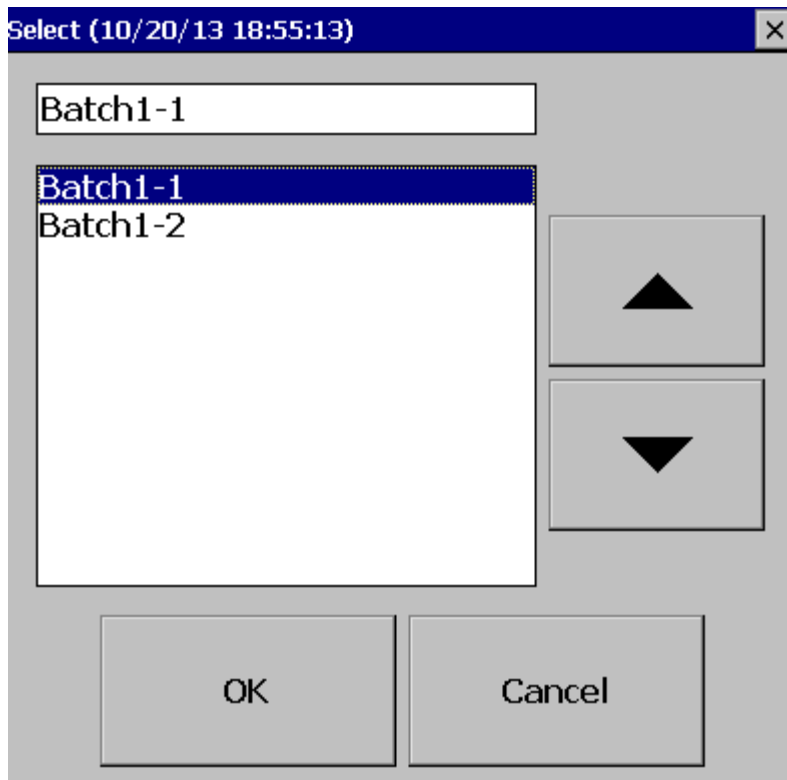

How to Dump Batch data to external USB memory

Press on  (Menu)-More then press on Dump

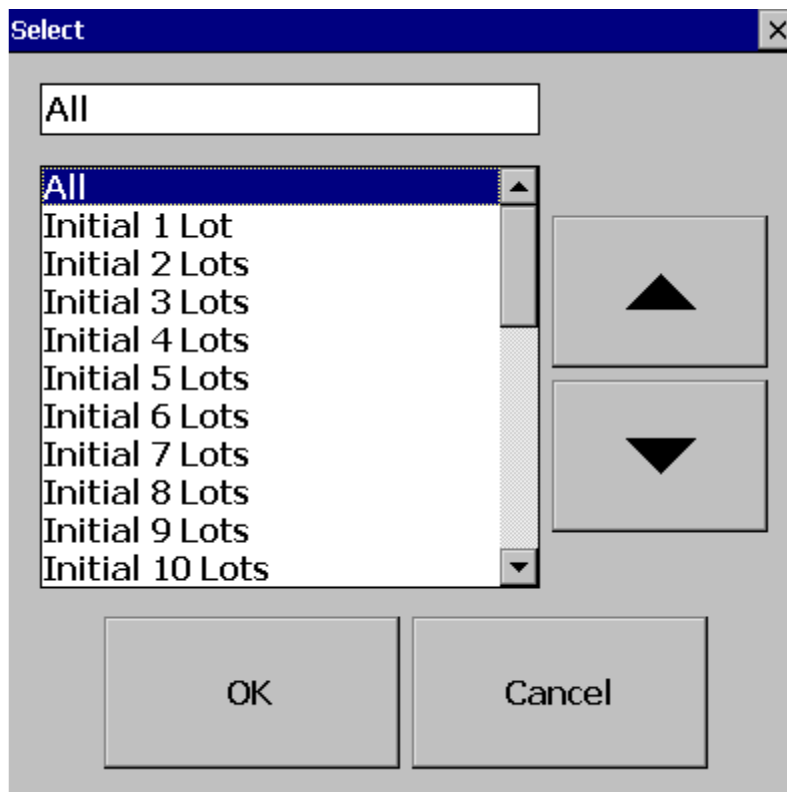

Select "All" or required lots and press "OK"

For ex: Batch1-1, Batch 1-2, Batch1-3 are available

Initial 1 Lot means, Batch1-1

Initial 2 Lots means, Batch1-1 and Batch1-2

Initial 3 Lots means, Batch1-1, Batch1-2 and Batch1-3

Note: Provision not available to dump only specific lot.

Please refer Instrument->Data Transfer-> Transfer and Remain

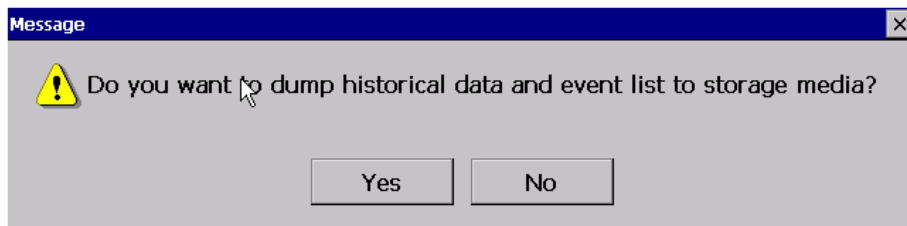

Press on "Yes" to dump data from internal memory to external SD Card or USB memory.

If you have 3 batches, let's say Batch1-1, Batch1-2 and Batch1-3, then you can see three different folders in the external USB memory card after completing of dump



Please note that the data available in USB memory is in a proprietary format to avoid any kind of tampering. You will need PC software to view this data.

4.12 Calibrate

This function is used for calibrating Individual Analog channel. This can be protected by password.

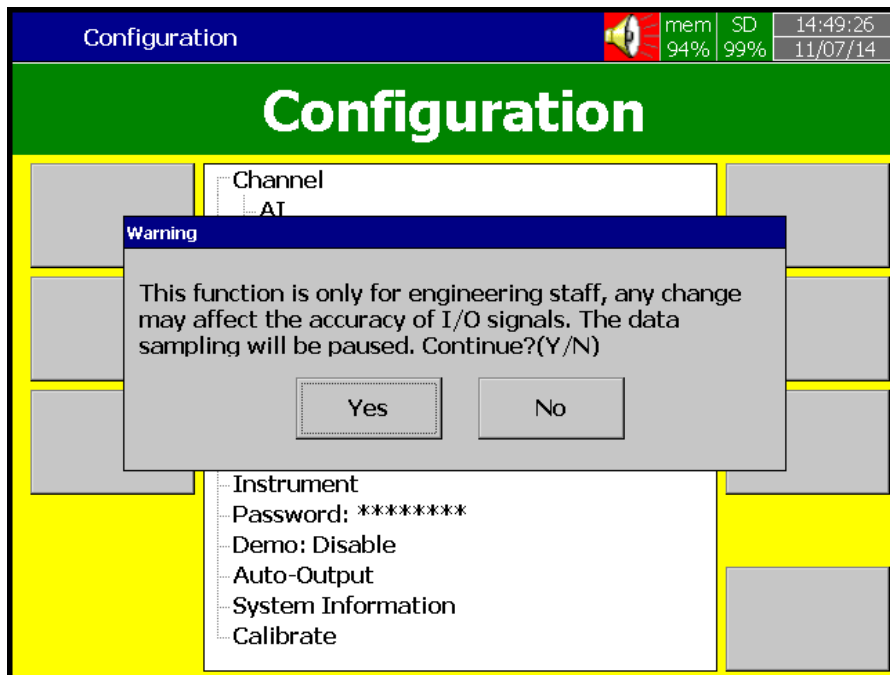

Example 1:

Calibrate an AI with 0-5V

When you click Calibrate menu, the user can see the below screen. Please click calibrate as shown in the below screen

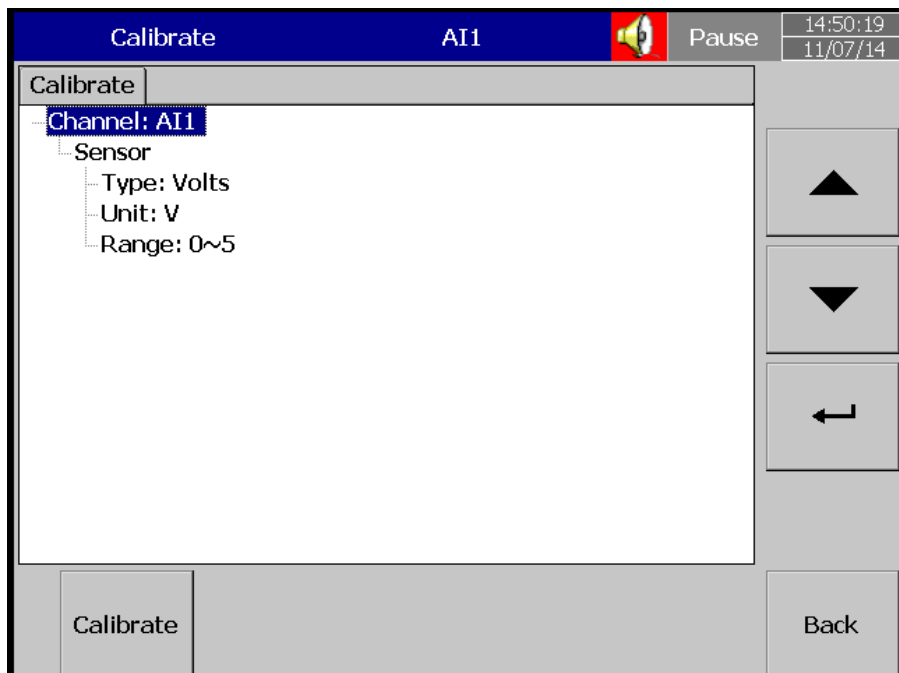

Please note that , Inorder to calibrate the whole Module slot accurately , the 3rd channel of each slot must be calibrated first. Click OK.

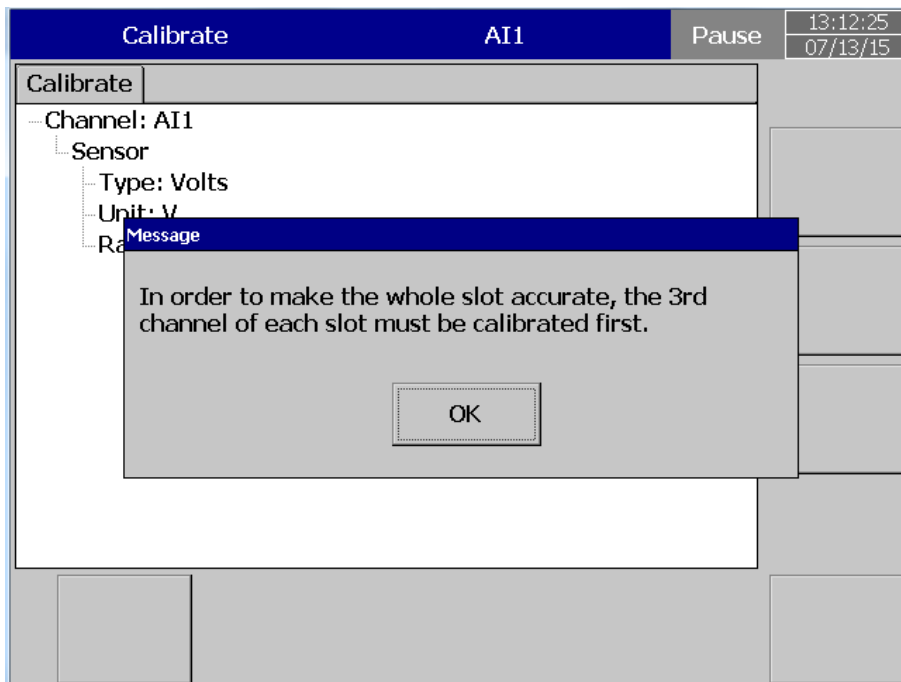

Now click Calibrate button as shown below.

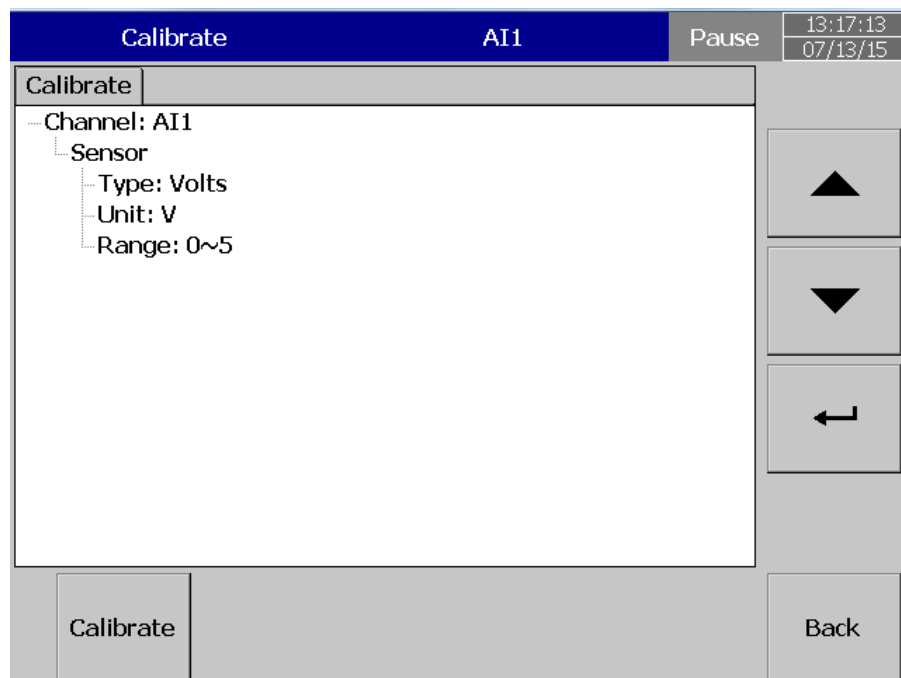

Click yes and proceed with the calibration process

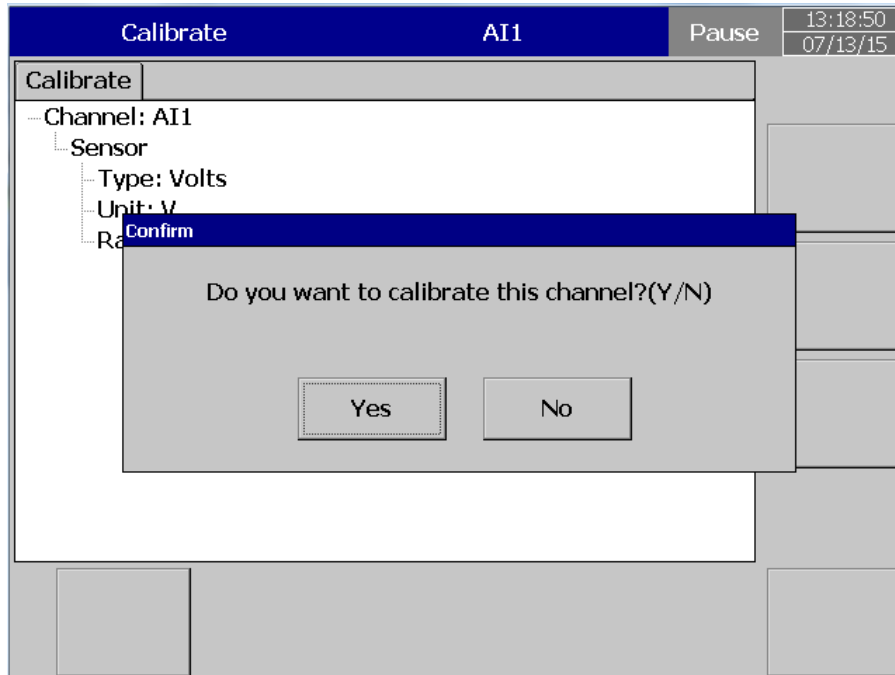

Please follow the next instruction, input 0V in to the input which can be seen in below screen

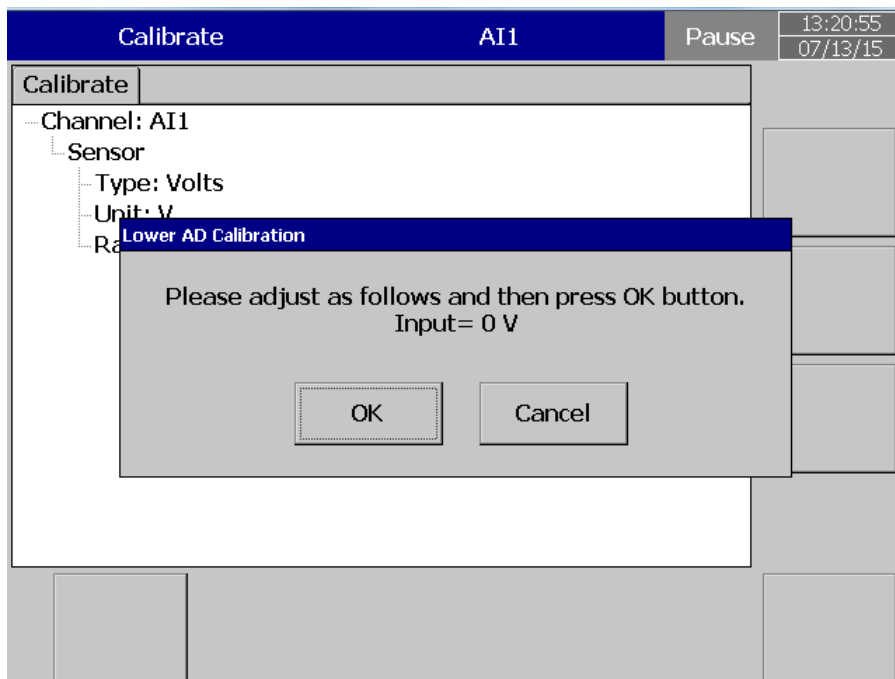

After you input 0V and select ok, the user can see the below screen.
Now follow the next instruction.

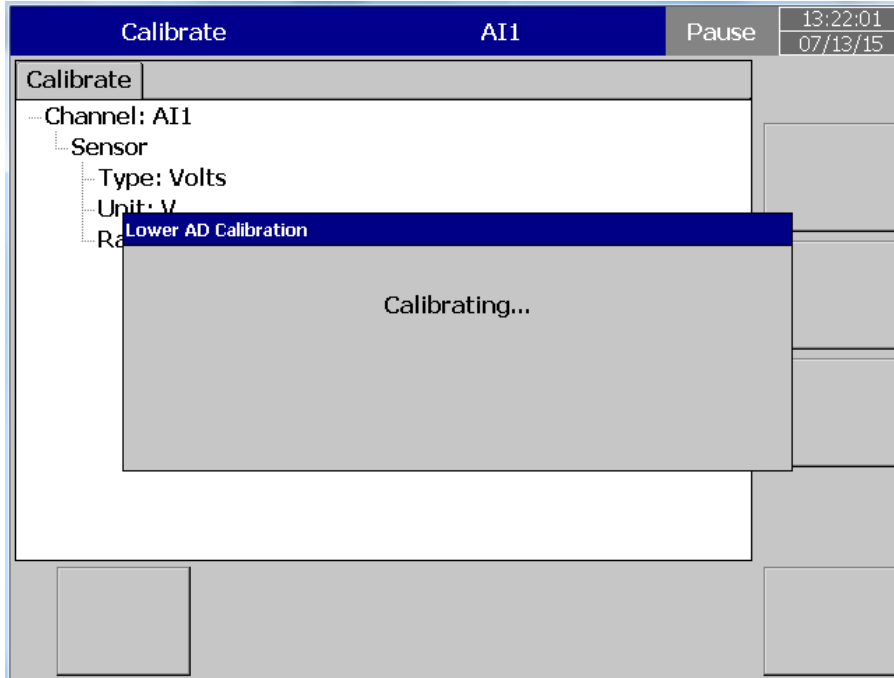

Now input 5V and click ok

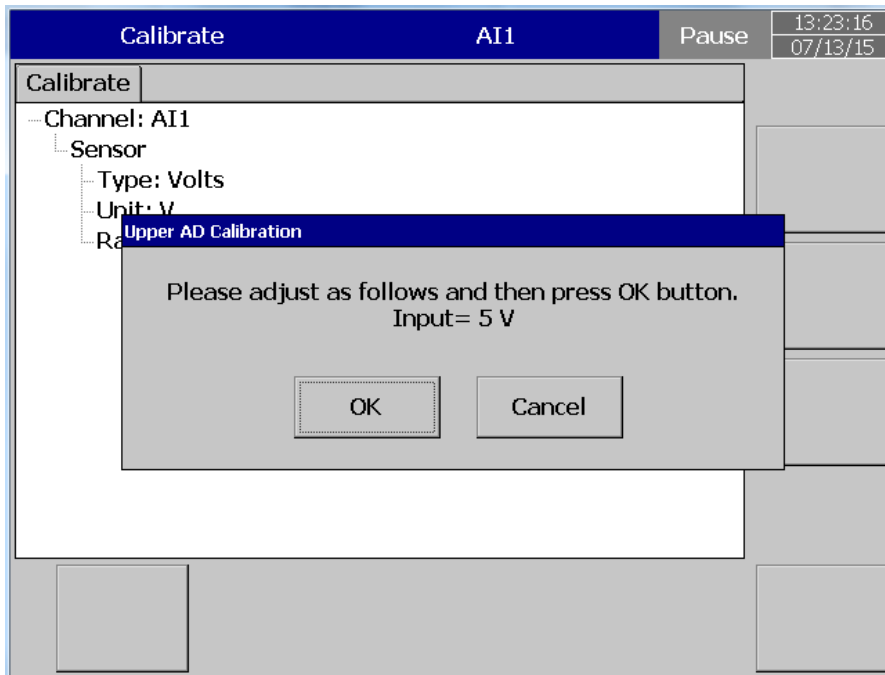

After you input 5V and select ok, the user can see the below screen
Now follow the next instruction.

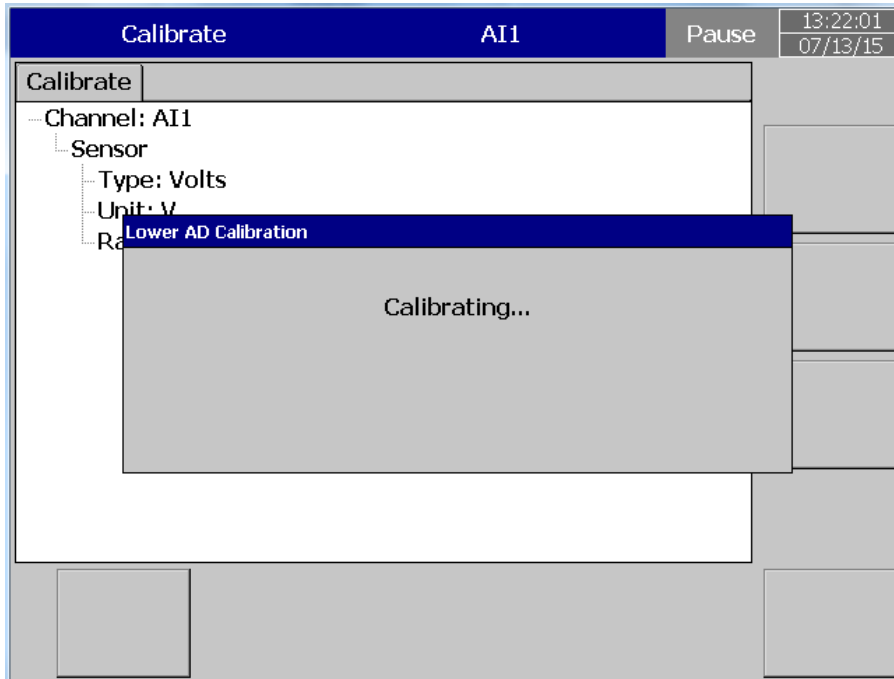

When the calibration is done successfully, the user can see below screen.

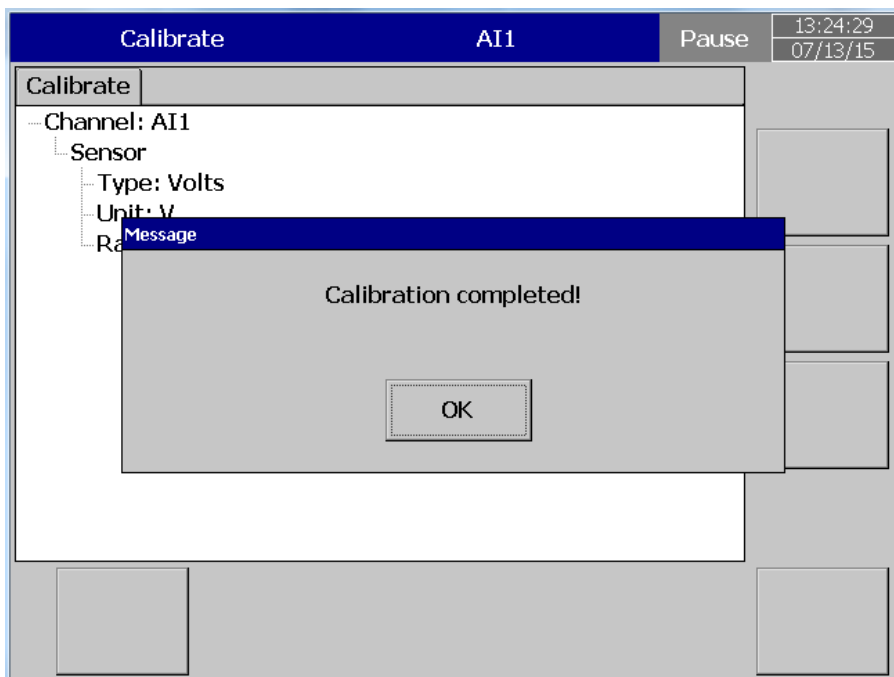

Example 2:

Calibrate an AI with K-Type Thermocouple

Please note that, Inorder to calibrate the whole Module slot accurately, the 3rd channel of each slot must be calibrated first. Click OK.

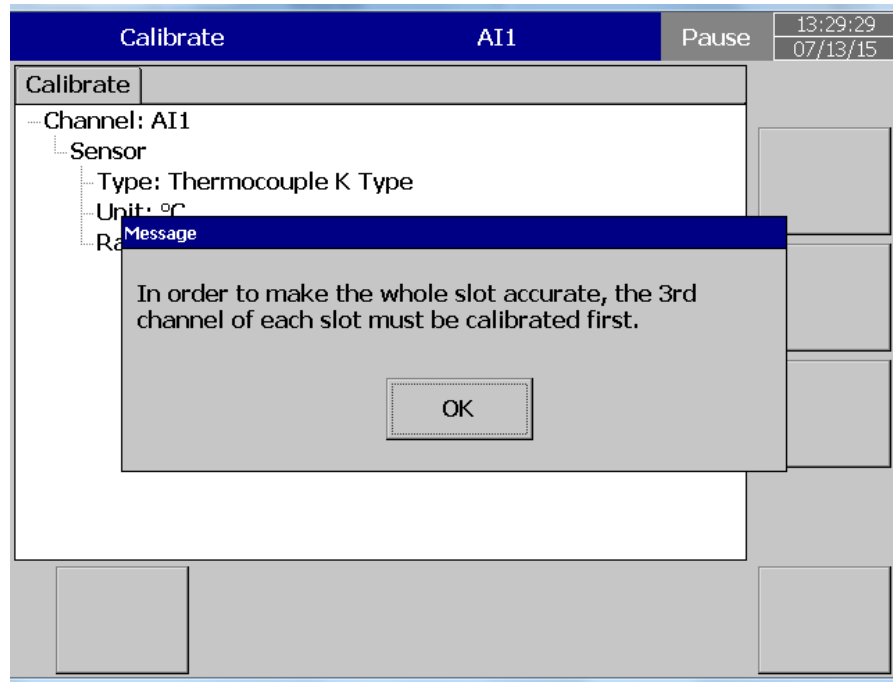

When you click Calibrate menu, the user can see the below screen. Please click calibrate as shown in the below screen

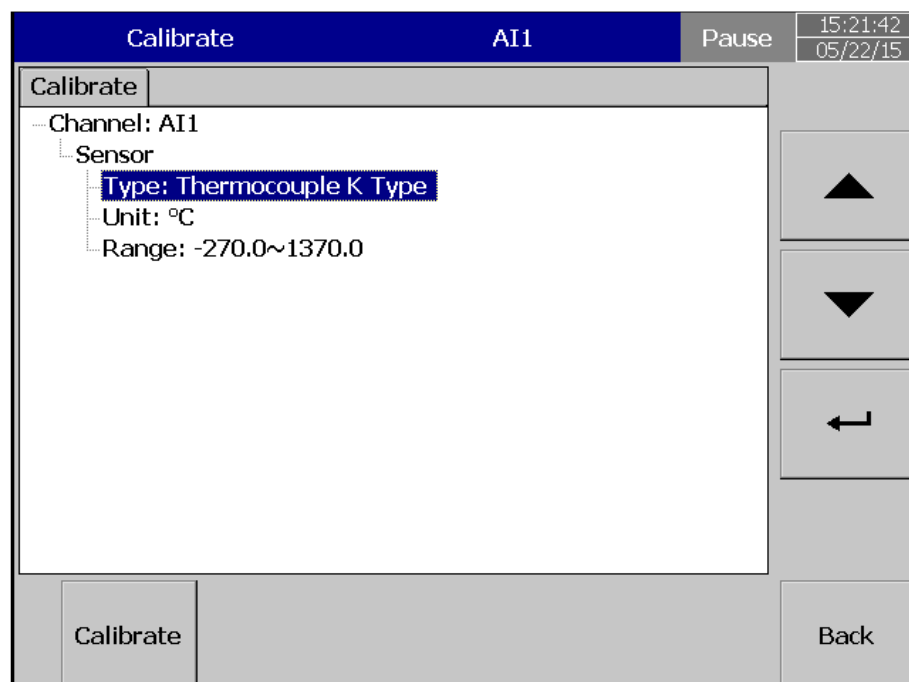

Click yes and proceed with the calibration process

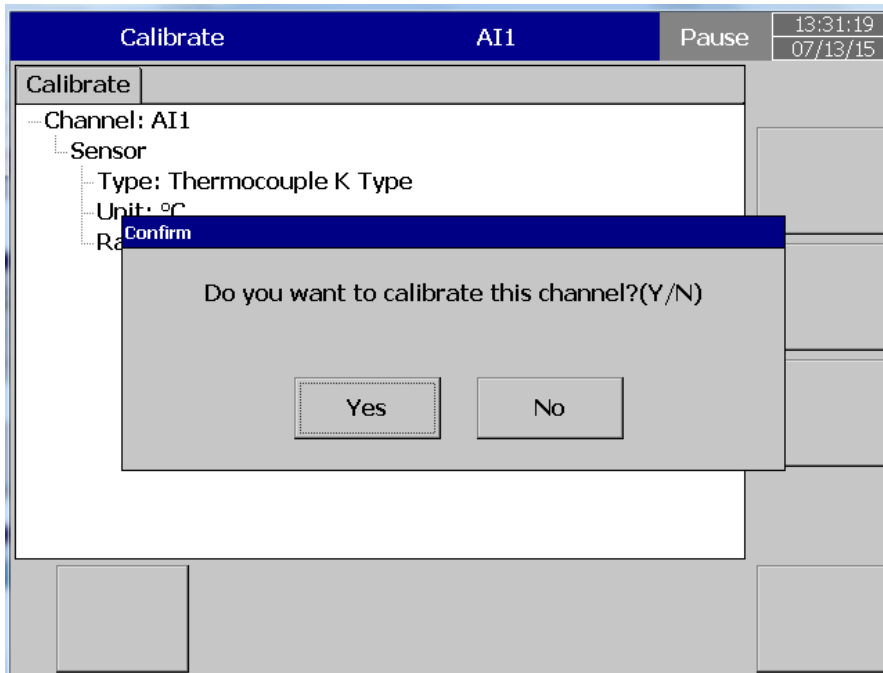

Please follow the next instruction, input 0 mV in to the input which can be seen in below screen

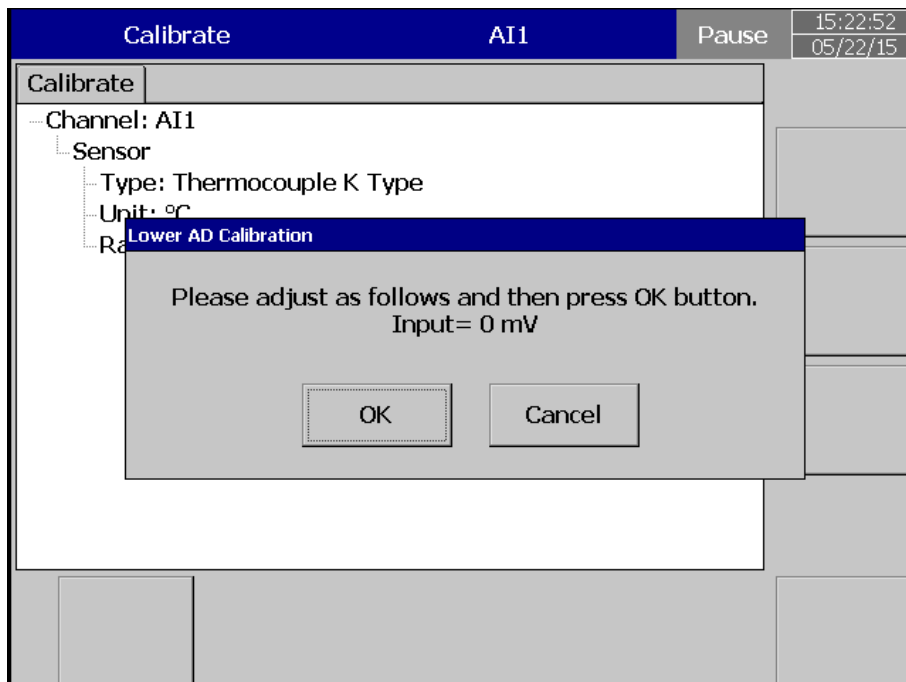

After you input 0V and select ok, the user can see the below screen.
Now follow the next instruction.

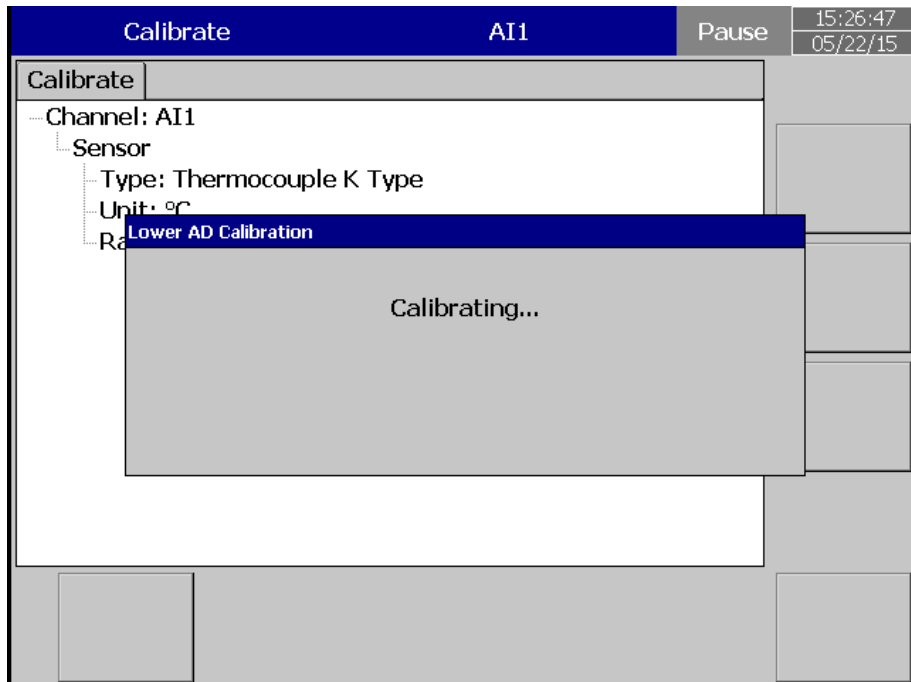

Now input 60mV and click ok

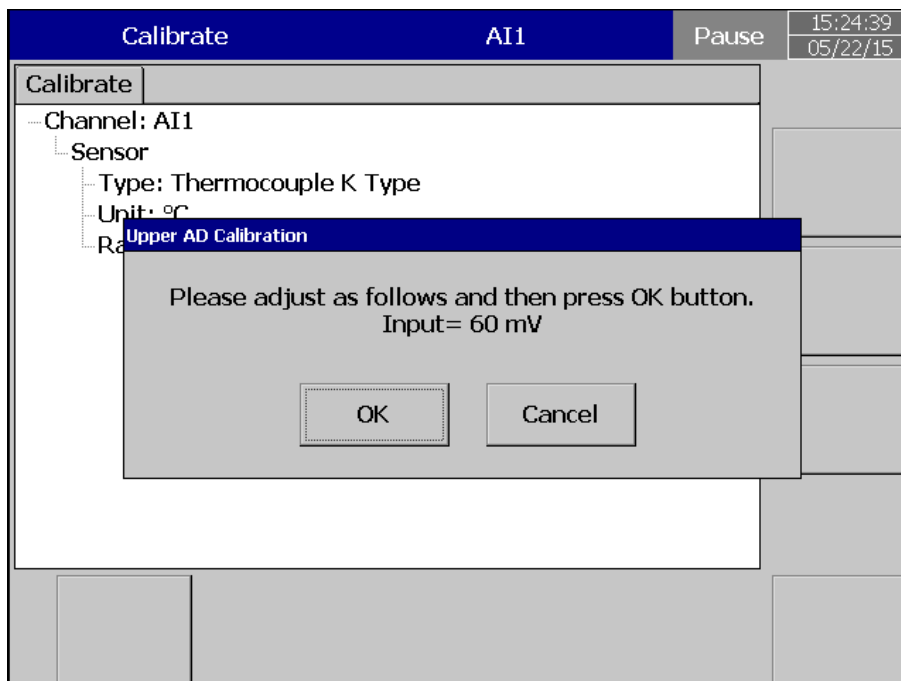

After you input 60 mV and select ok, the user can see the below screen
Now follow the next instruction.

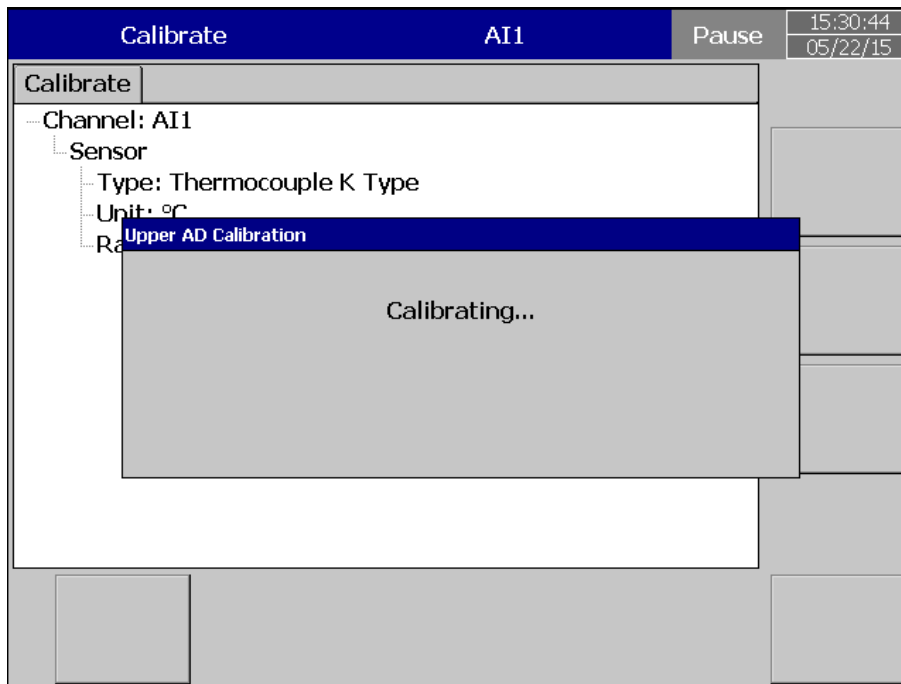

Now input 0°C from the simulator and press ok ,

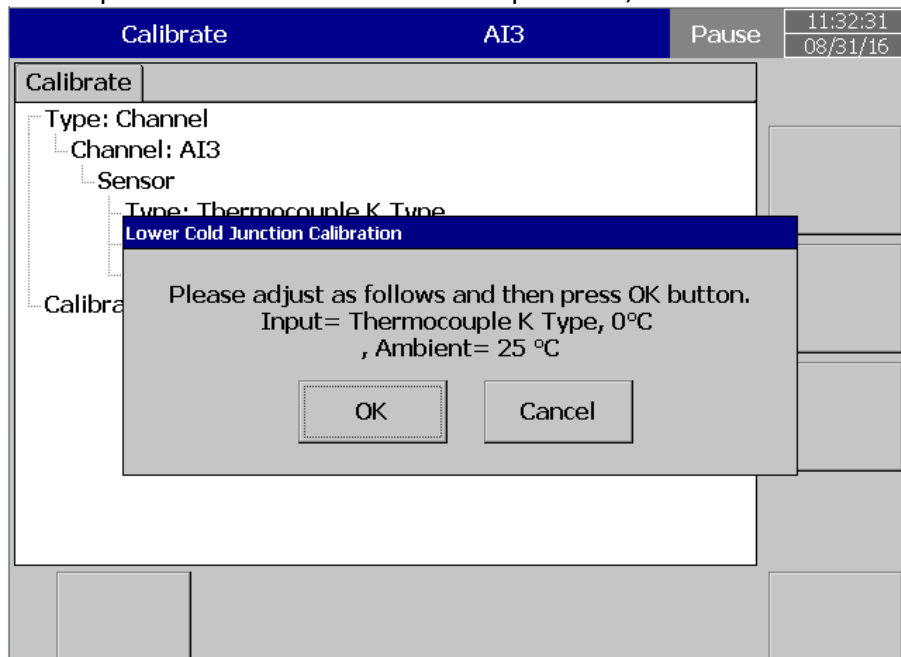

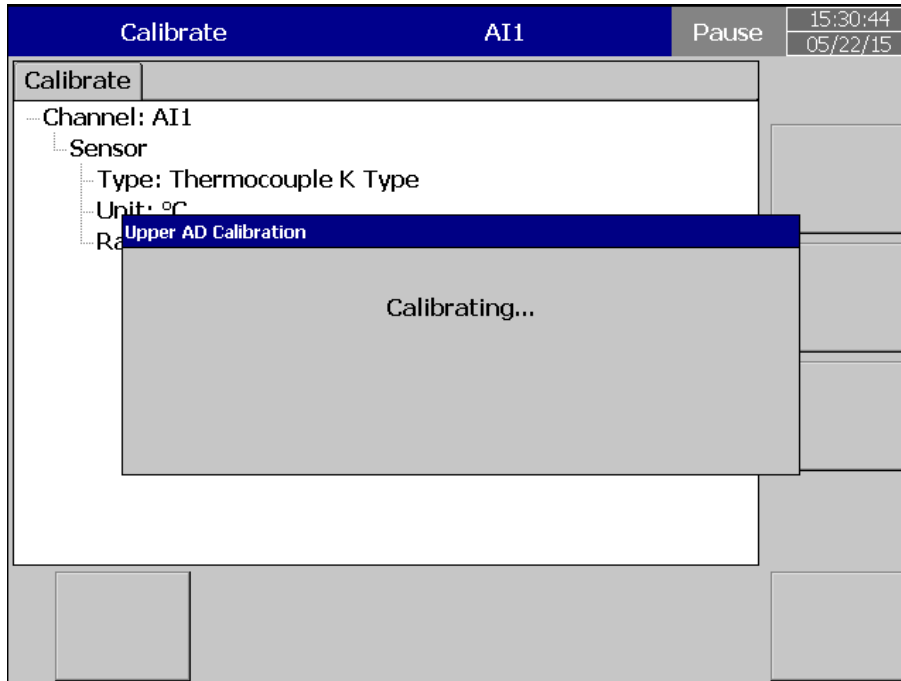

When the calibration is done successfully, the user can see below screen

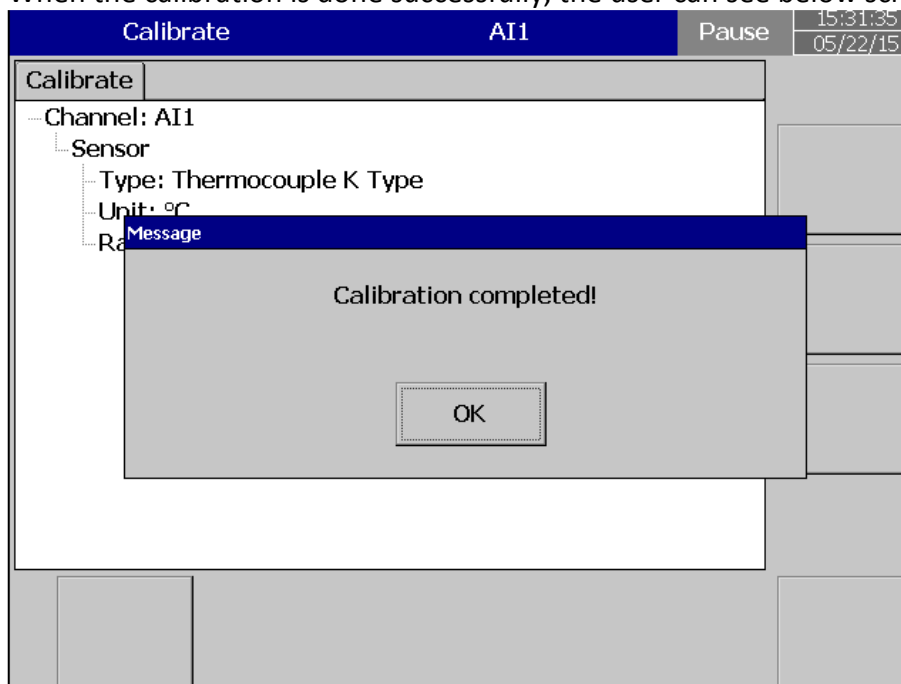

Calibrate an AO with 4-20mA

When you click Calibrate menu, the user can see the below screen. Please click calibrate as shown in the below screen

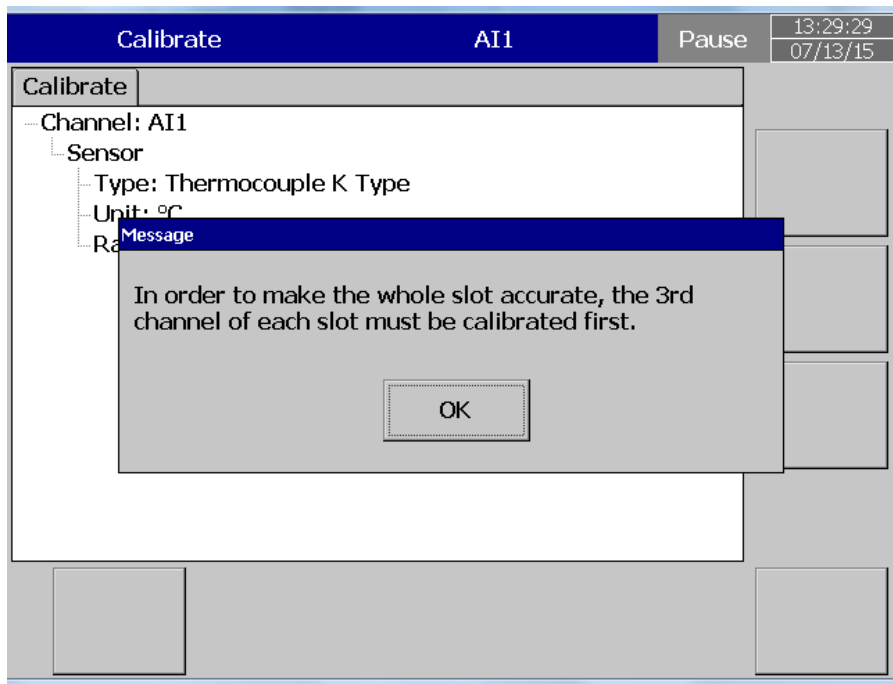

Click ok and proceed and select the channel of Analog Output to be calibrated.

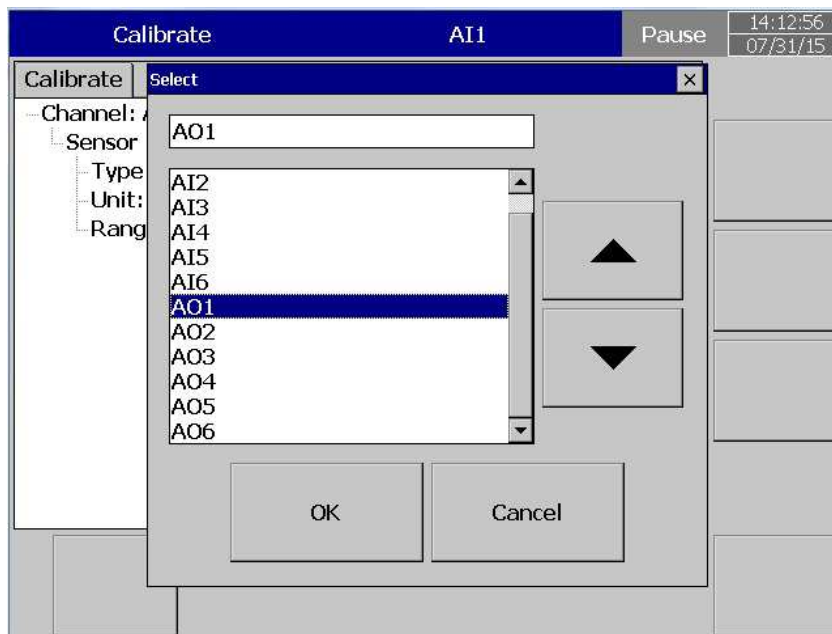

Confirm the channel to calibrate and click "Calibrate" and "yes" in the next screen

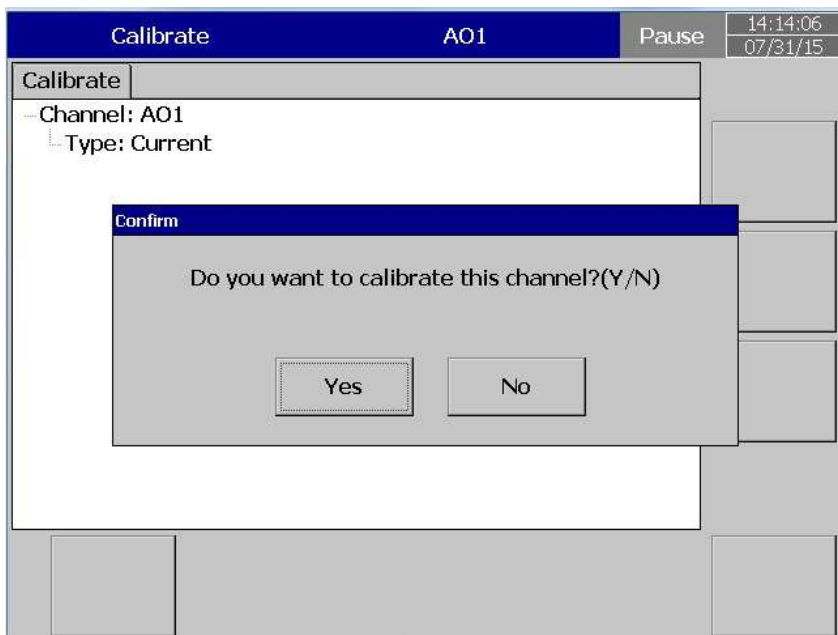
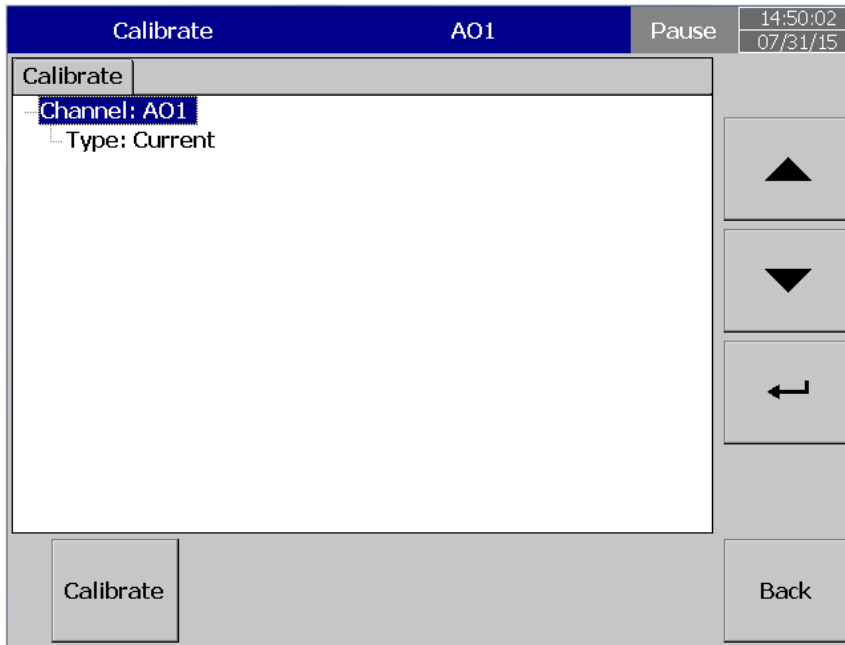

Please connect current meter before calibrating and click ok

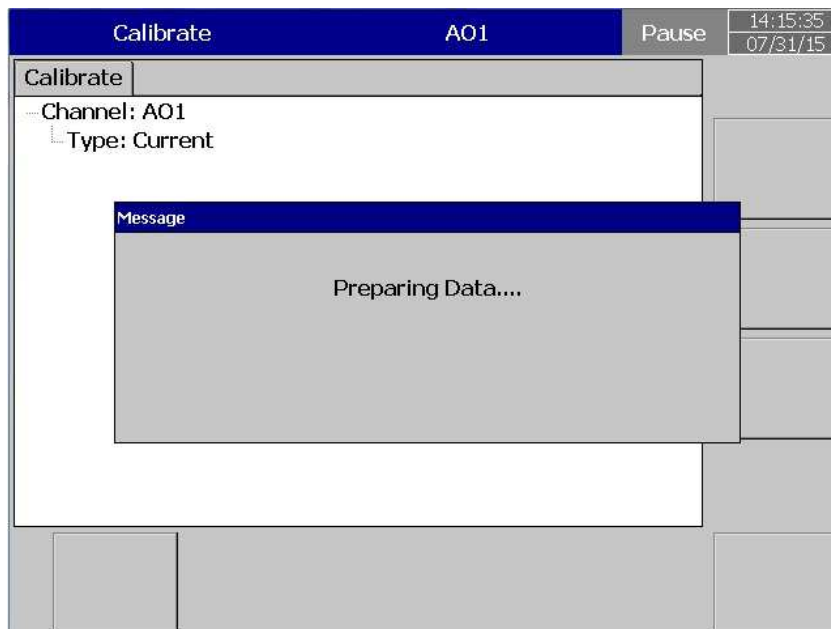
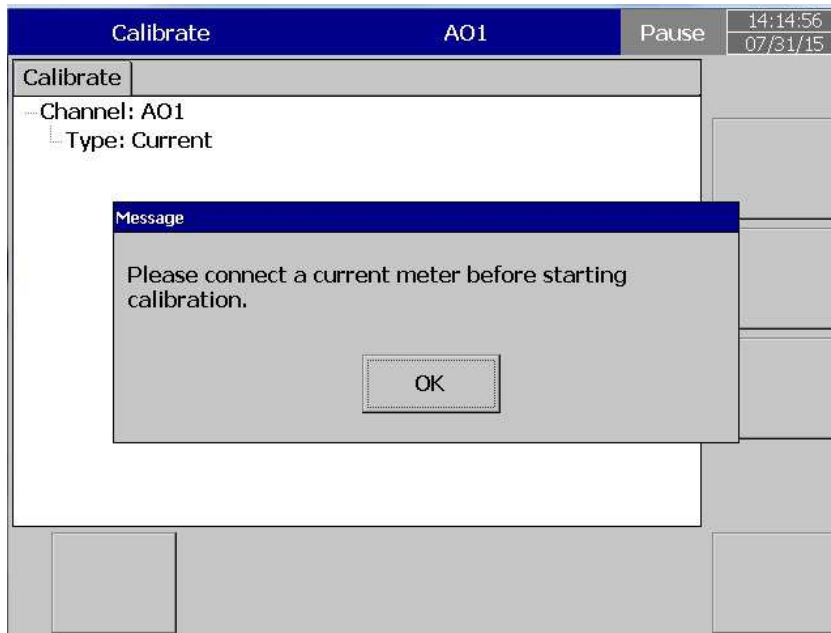

Then, input the value for Lower calibration, ie 2.7308 mA after clicking ok

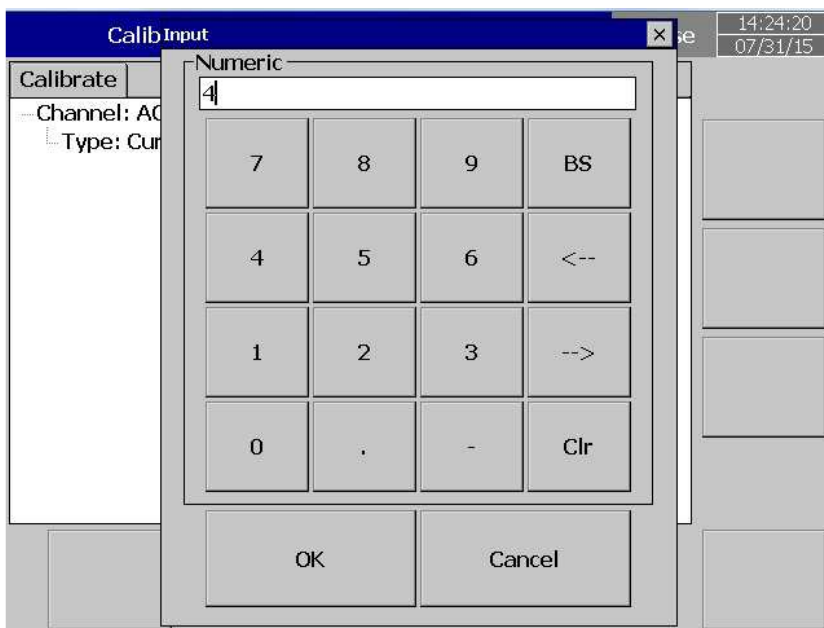
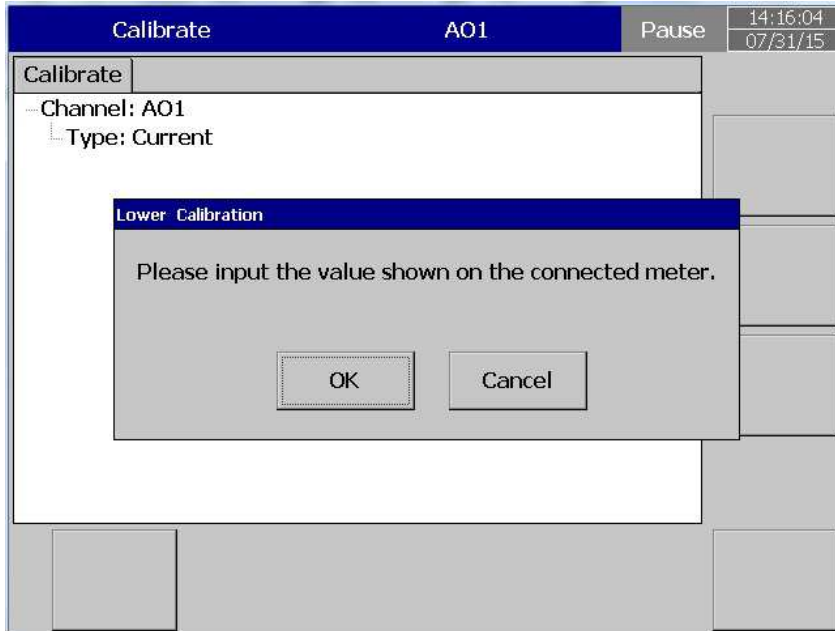

Lower calibration is in progress

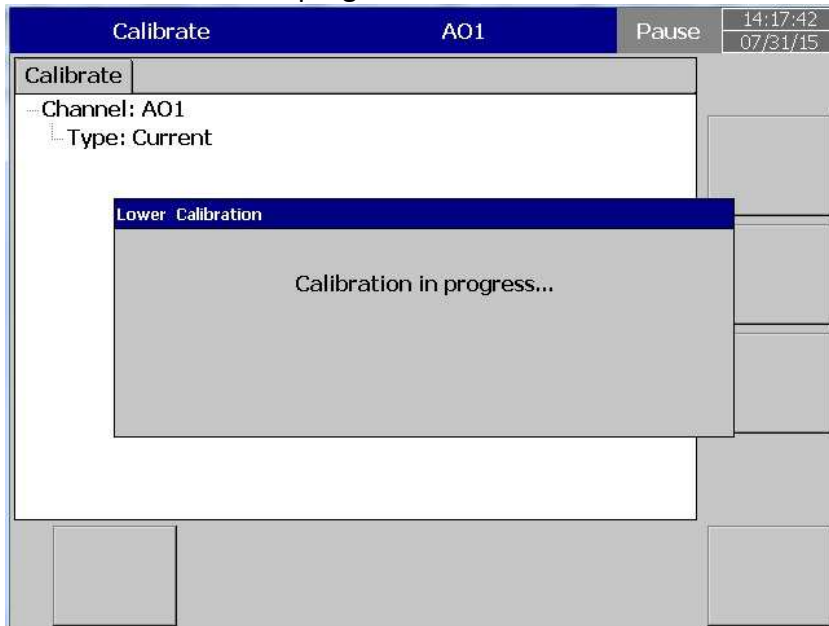

After we finish Lower calibration now we need go for Upper calibration

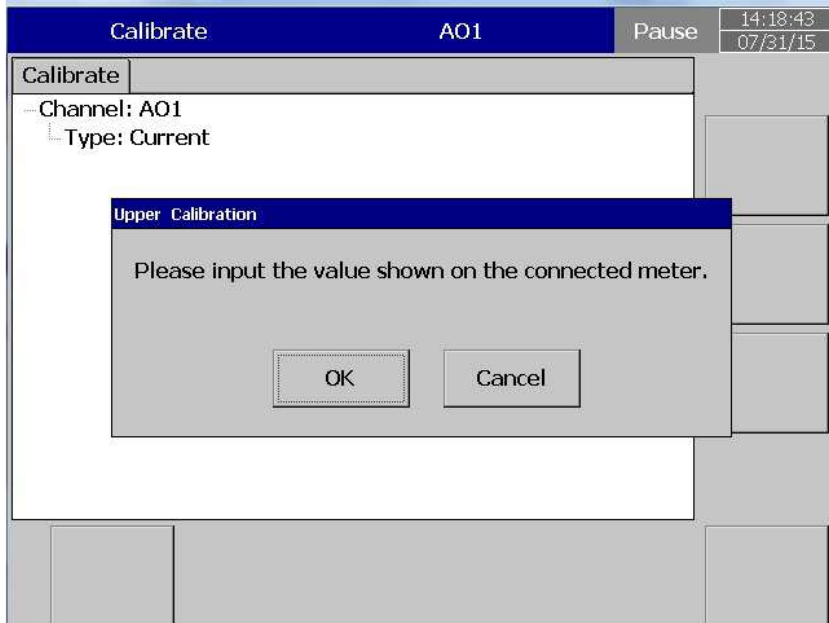

After click ok on the above enter upper calibration value as 18.745 mA and click ok

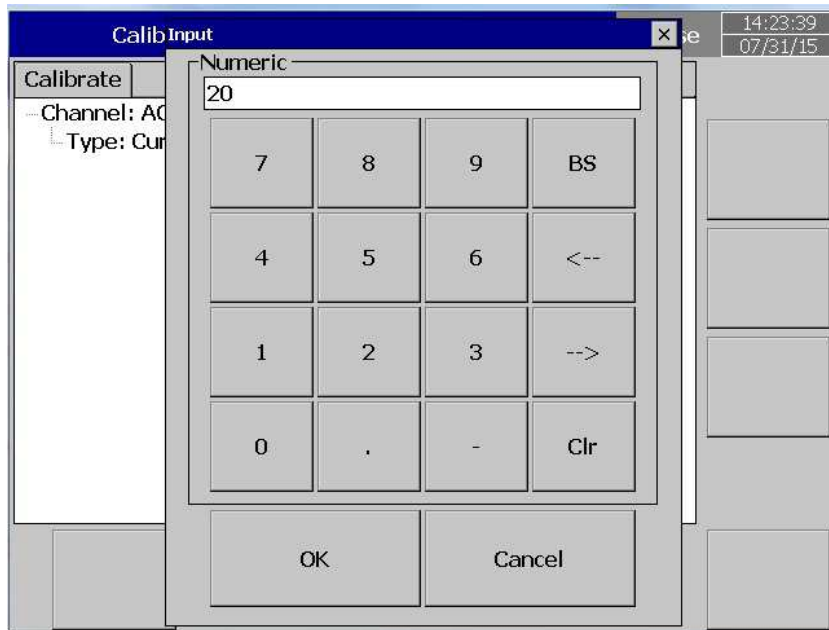

Upper calibration is in progress

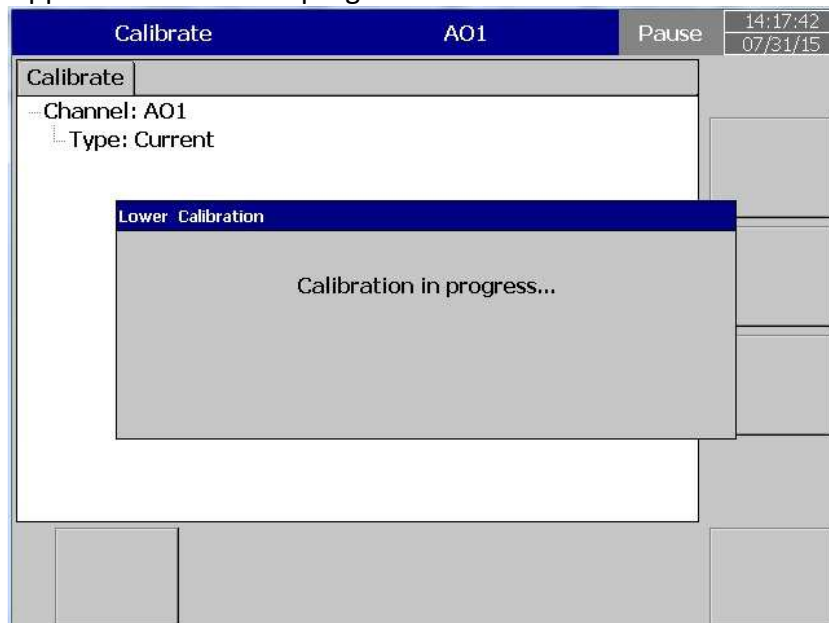

After we finish Upper calibration now we need go for entering Offset

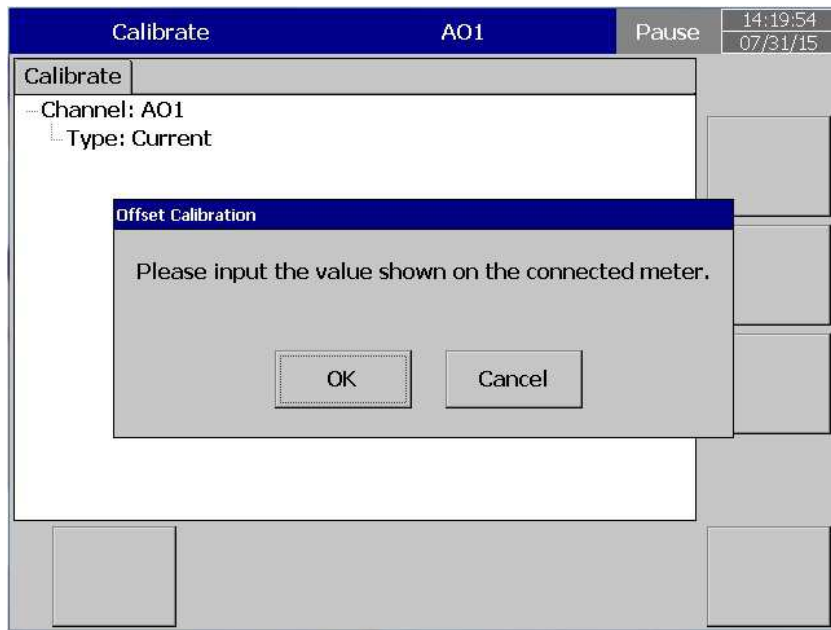

we enter 3.7554 mA as offset

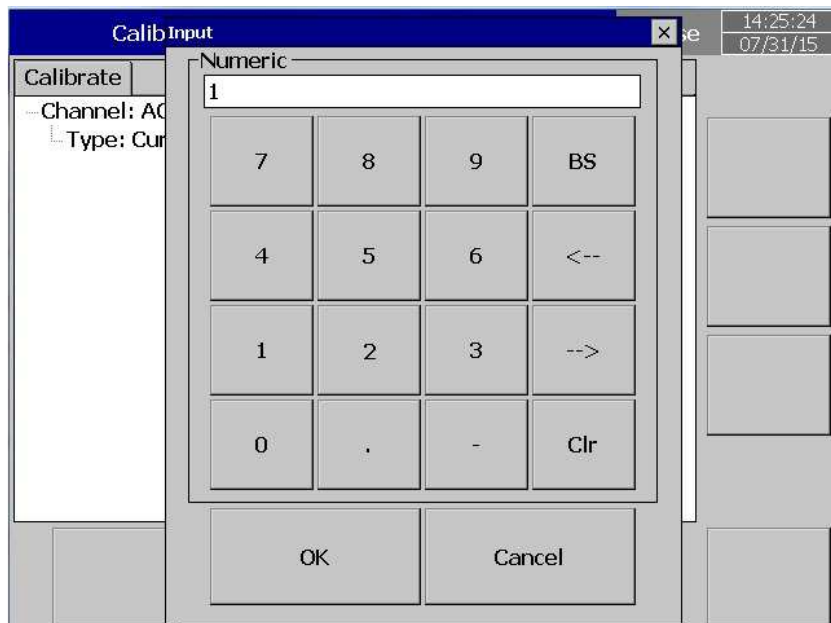

Offset calibration in progress

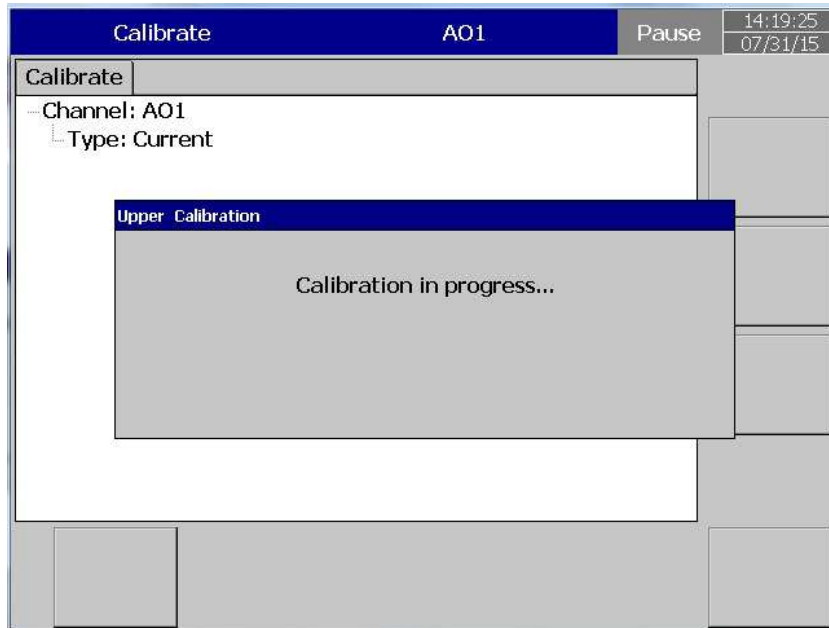

When the calibration is complete, we can see the below screen

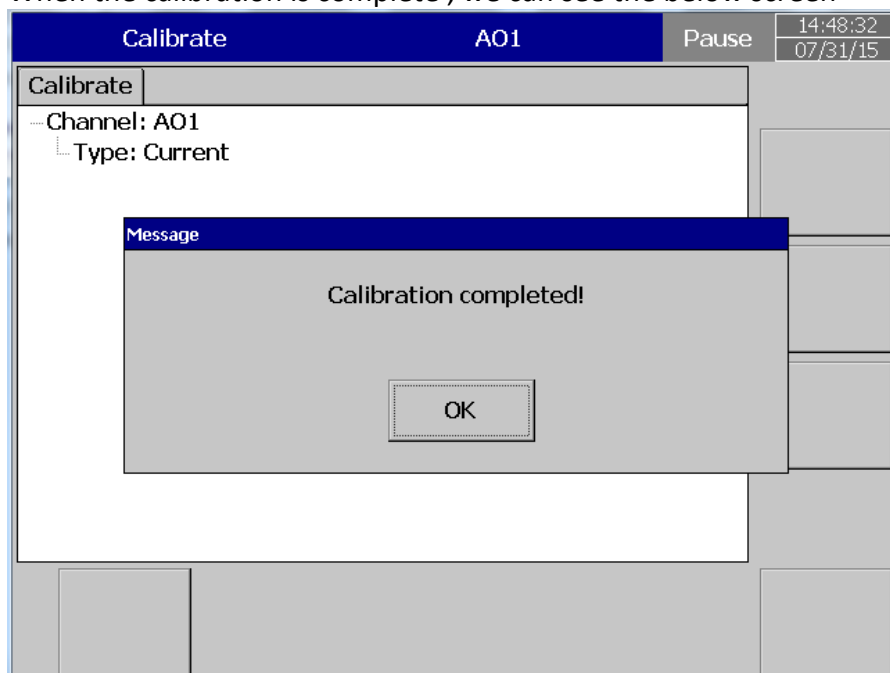

Note:

Channel #3 should be calibrated first in all types of Analog Input cards.

An analog temperature sensor is installed in channel # 3. When channel # 3 is calibrating, the cold junction voltage measured by this temperature sensor will be loaded into a register.

If channel # 3 is not calibrated, the default value of cold junction voltage will be used for all channels. It does not matter what order you perform calibration after calibrating input 3, there is no need to follow a sequence, and any one of T/C, RTD, mA or VDC can be done independently.

4.13 Procedure To Upgrade and Restore Factory Default Settings

Power ON the Recorder while Pressing the Reset Button

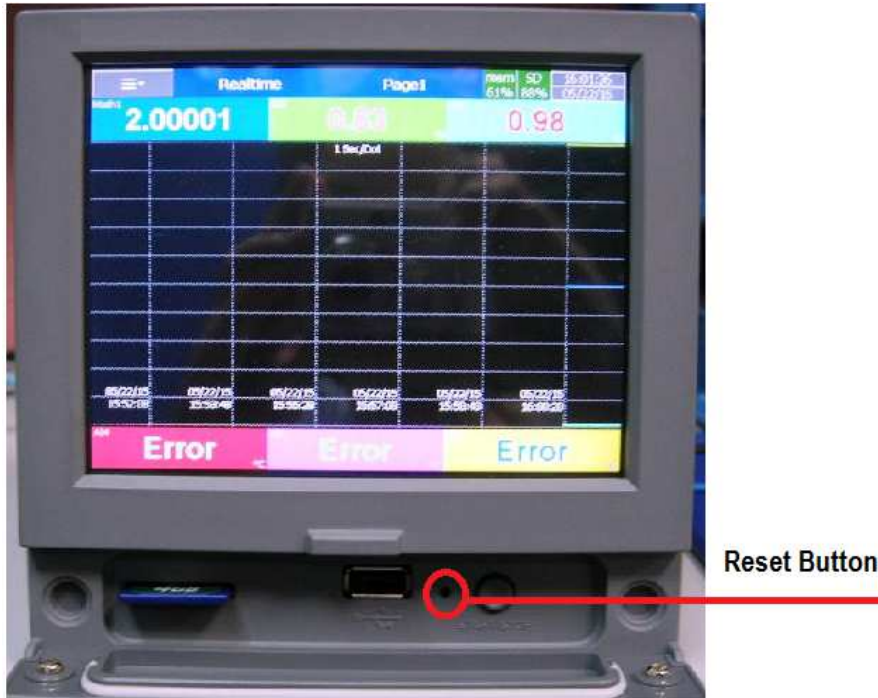

Now the Screen will appear like below

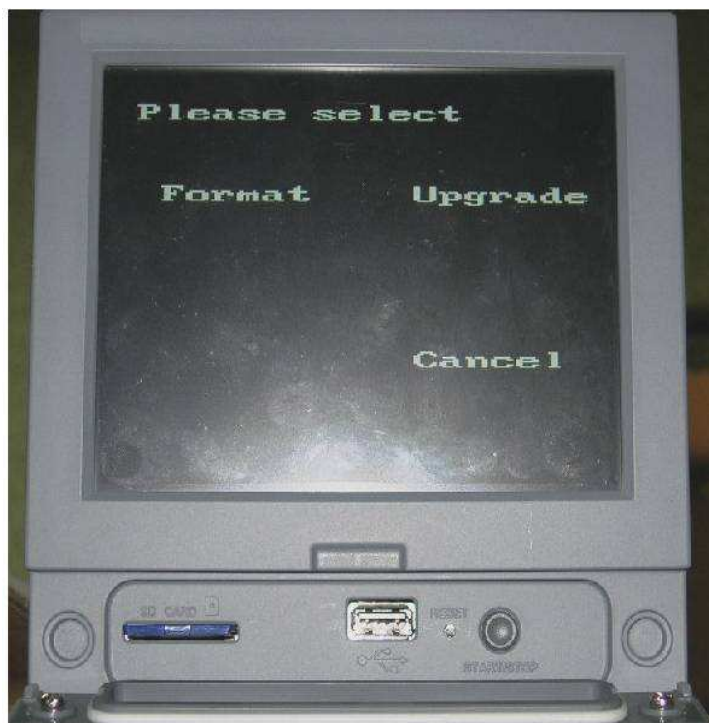

Format:

Press the Format Button for at least 3 Seconds to return the Recorder to factory Settings.

After the Recorder is done formatting, it will ask for Screen Calibration.

Do the Screen Calibration.

The recorder has now been returned to factory default settings.

Upgrade:

Download the Firmware from the FTP Link Given (.bin file, its compressed , it needs to be un zipped).

Copy the File to the SD Card. Be sure the SD card is formatted to FAT32.

Insert the SD Card to the SD Card Slot on the Recorder.

Press Upgrade Button for at least 3 Seconds to upgrade the image from SD Card.

Follow the on-Screen instructions.

5. PC BASED SOFTWARE

By using this software you can configure the settings of the Recorder offline and online. Trends of configured channels can be viewed in PC by using this.

This has got 4 Options:

5.1 Free Basic Software

5.1.1 Requirements

Hardware

Recommended hardware

PC with 2 GHz processor, 1GB RAM

50GB free space in the hard disk.

Ethernet port, RJ 45 female/ USB port

Minimum 20% free space in hard disk, Less than 10% space generates an error message

5.1.2 Operating system

Windows based Operating systems, Windows XP, Windows 7, Windows 8 etc..
32 bit and 64 bit operating systems are supported

5.1.3 Software

Software installation

1. Install latest dotNet software from Microsoft website
2. Install the software
3.  Historical viewer icon desktop shortcut will be created after installation of software
4. Historical viewer can be accessed from the following path as well
Start-Programs-Historical viewer-Historical viewer.

The Software contains:



HIST_VIEWER is for monitoring historical trends and also for configuration of recorder parameters via the PC.

Uninstall the free Software

This is to remove previous versions of free software from PC.

HIST_VIEWER



How to set configuration of the Recorder from PC.

Start-Programs-Historical Viewer

Tool bar



To open new project



To open existing project file

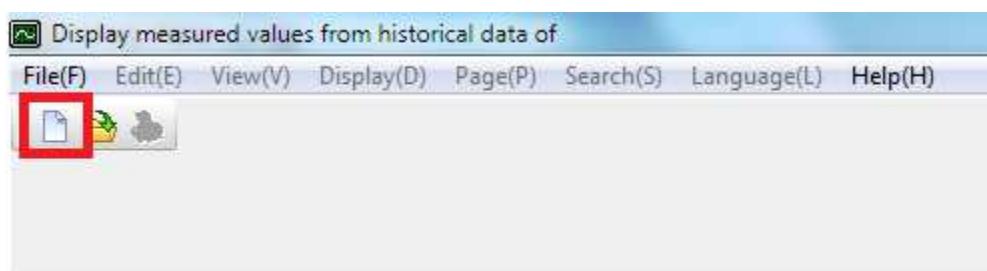

When the User clicks the icon new (shown in the above picture in the red square), they can view the below menu where they can select the Recorder (PR) and click ok.



After that, the user must give a name to the project and select the location of project (as shown in the below figure). If the user already has the configuration stored in a SD card or USB, they can select the path accordingly.

If the User wants to configure the Recorder for the first time via Ethernet, they must select Ethernet, and enter the correct IP address of the Recorder.

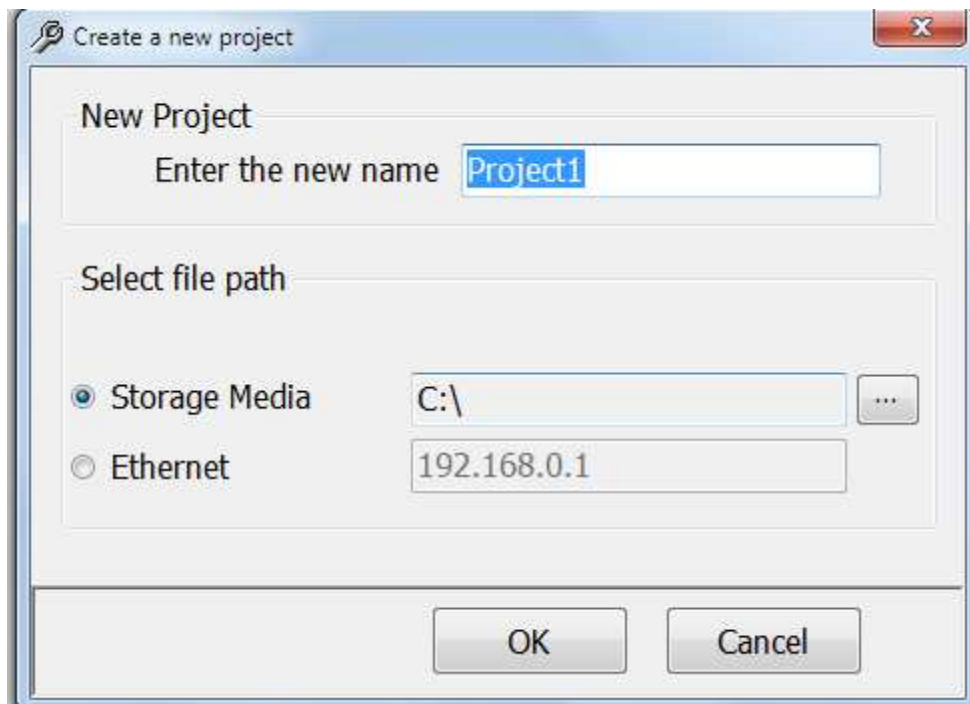

If the User wants to open file in the software, already configured in the PC, then they can select *.prj file to open the project.

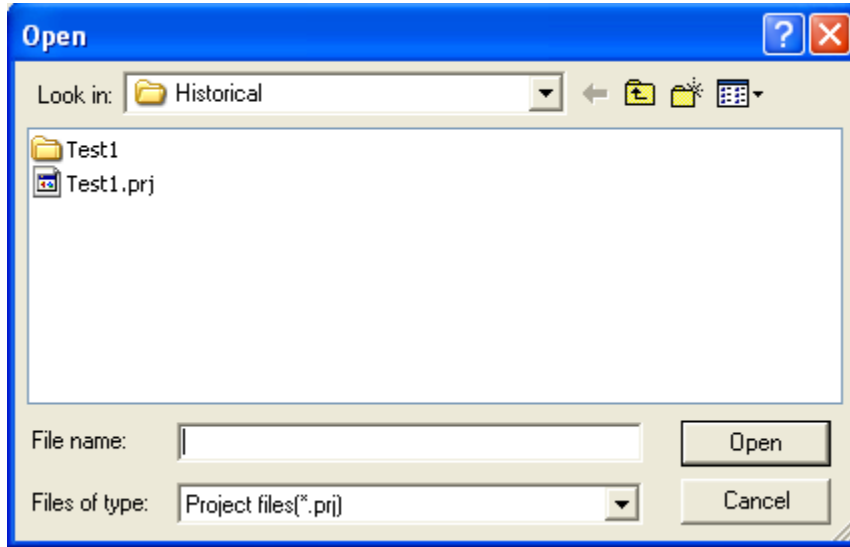

 To save the project file settings in PC

 Receive configuration (Storage Media/Ethernet)

 Send configuration (Storage Media/Ethernet)

If the software is already configured in the PC, then you can select *.prj file to open the project.

Bank 

This is used to select the physical connection between the Recorder and PC.

Two options are available:

Storage Media

Ethernet

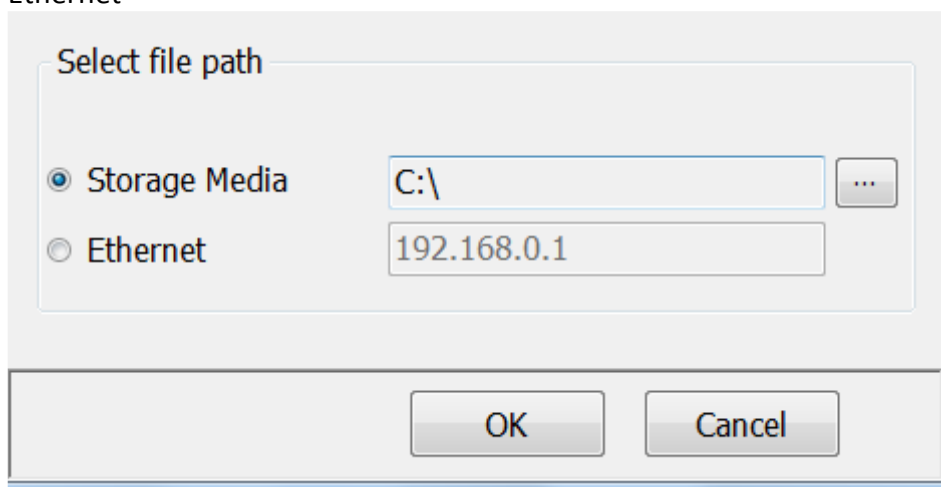

Standard Ethernet port (RJ 45 female) shall be available at the Recorder. RS 232/RS485 shall be supplied as additional options.

5.1.4 Ethernet Configuration

It is possible to use PC software for data logging of Recorders connected on standard Ethernet. A maximum of 1024 tags can be configured for data logging, archiving and analysis. The tags cover AI, Math, DI, DO, Counter & Totalizer.

1. Make sure that the network adapter in the PC is properly configured. IP address, Subnet mask and Gateway should be configured at the PC for using the Historical Viewer program. Please contact you System administrator to set a Unique IP address for the PC.
2. Install the Historical Viewer application software in your PC. The software may be installed from "setup" available in the CD supplied as per the order.
3. Ethernet configuration at the Recorder

Please refer to **4.5 Communication** for entering the IP address, subnet mask and gateway address manually at the Recorder.

Gateway refers to a device on a network that sends local area traffic to other networks.

Subnet mask numbers help to define the relationship between host and rest of the network.

For every LAN, the Network administrator shall define a Subnet mask and Gateway. Obtain the subnet mask and gateway address for the LAN at the place where the Recorder to be connected. Enter these details at the Recorder manually using front buttons.

By default, subnet mask address: 255.255.255.0

By default, Gate way: 0.0.0.0

Enter the Unique IP address to the Recorder and enter IP address at the Recorder manually. Contact your system administrator to obtain a free IP address available at user LAN. Naming duplicate IP addresses may disable the communication between the Recorder and PC/LAN HUB.

4. Local area network uses UTP cable for Ethernet connectivity. Maximum UTP cable distance between the Recorder and LAN/HUB/PC should be less than 100 Meters. If the distance is more than 100 Meters, additional LAN accessories/equipment may be required for increasing signal strength. Please contact your network administrator for more information on extending the LAN distance.

- Two different types of cables shall be used for connecting the Recorder on Ethernet as follows. For connecting the Recorder to LAN HUB, then standard straight-through Ethernet cable should be used. For connecting the Recorder to a PC/Laptop directly, a crossover Ethernet cable should be used.

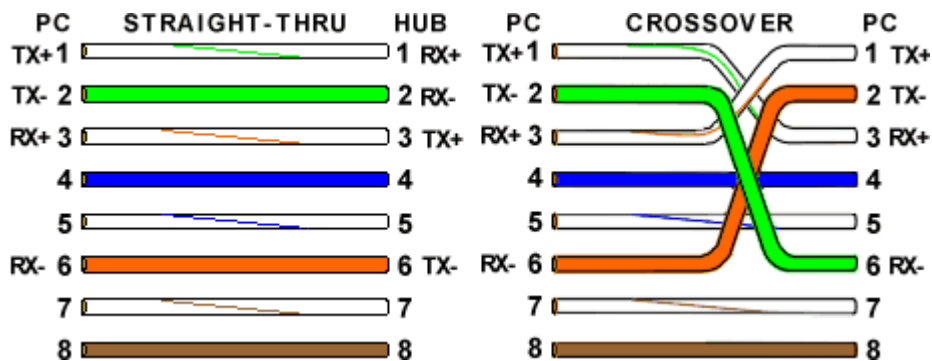
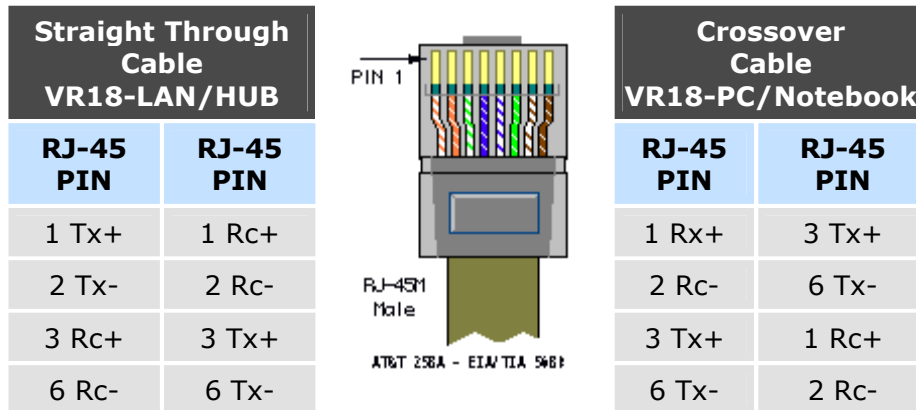

- Connect a proper UTP Ethernet cable per the requirements and observe the communication status between the Recorder and PC/LAN HUB at the LED's located near the female RJ 45 connectors.

Recorder side

Link (Green LED)

Green lit: Cable connected between the Recorder and PC/LAN HUB

Green Off: No Link between the Recorder and PC/LAN HUB

Tx/Rx

Orange Lit continuous: No cable connection

Orange slow blink: Communication established between Recorder & PC/LAN HUB

If the download is successful, the User can see the below screen.

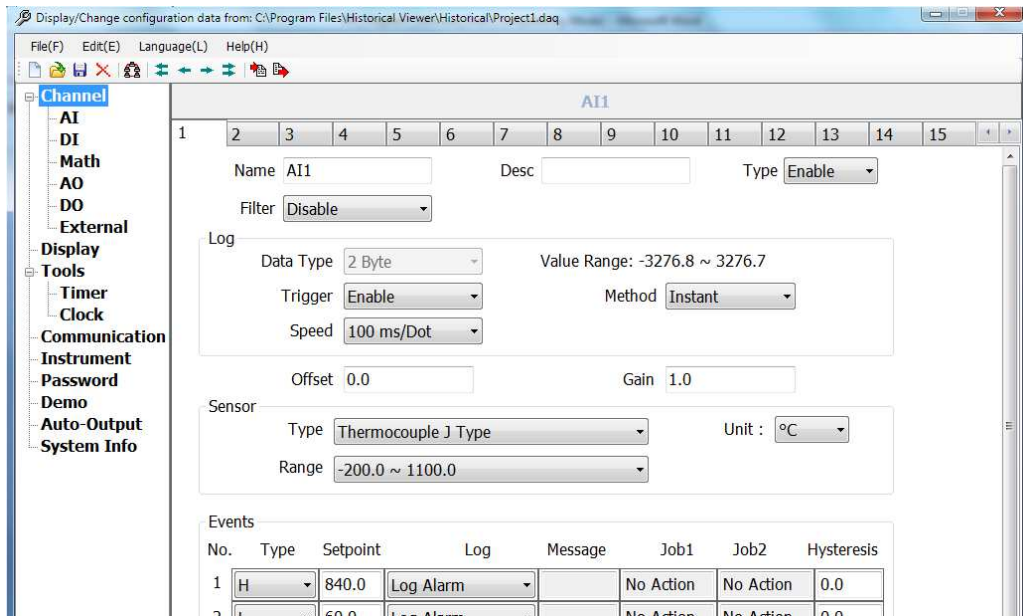

If Upload is unsuccessful, the recorder shows the message “No response from Recorder, connection fails”.

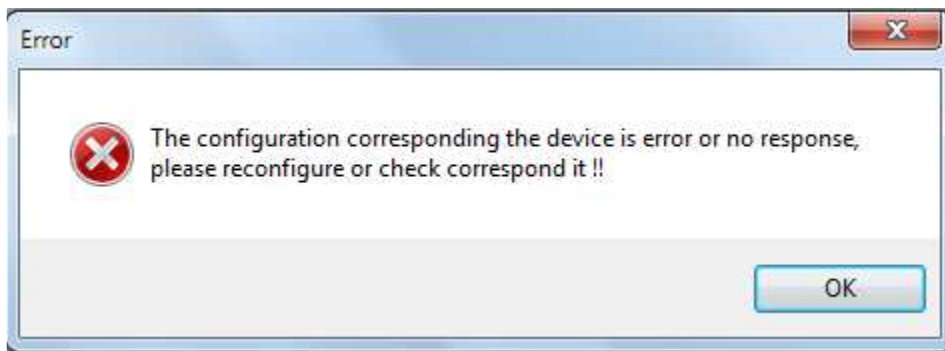

If this is the case, please check the Ethernet cable connections at both the Recorder and PC/LAN HUB side. Also make sure that green communication LED is lit which shows there is a proper firm connection at the RJ 45 connector.

If still communication is not established between the Recorder & PC, then once again check Subnet mask and gateway address at the Recorder & PC. Contact Network/ System administrator for proper Ethernet configuration of the Recorder & PC. Please note that Recorder should have a unique IP

address in the network and PC that is using the software shall have a separate Unique IP address in the network.

Now you see the configuration screen,

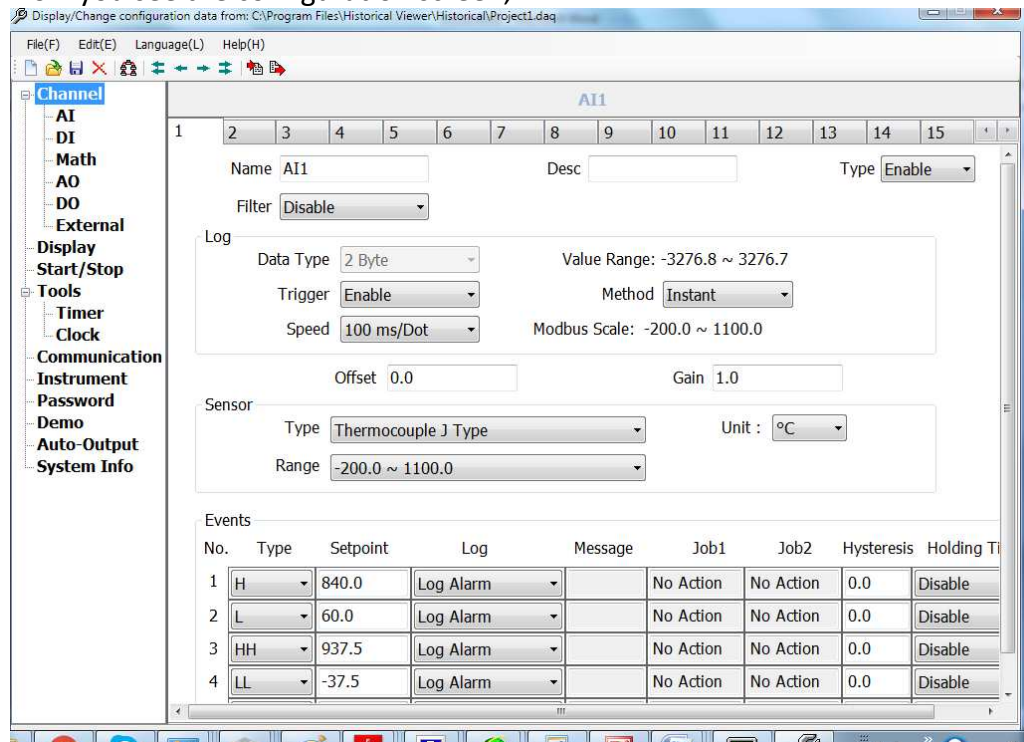

close the screen, its asks to save data , click yes

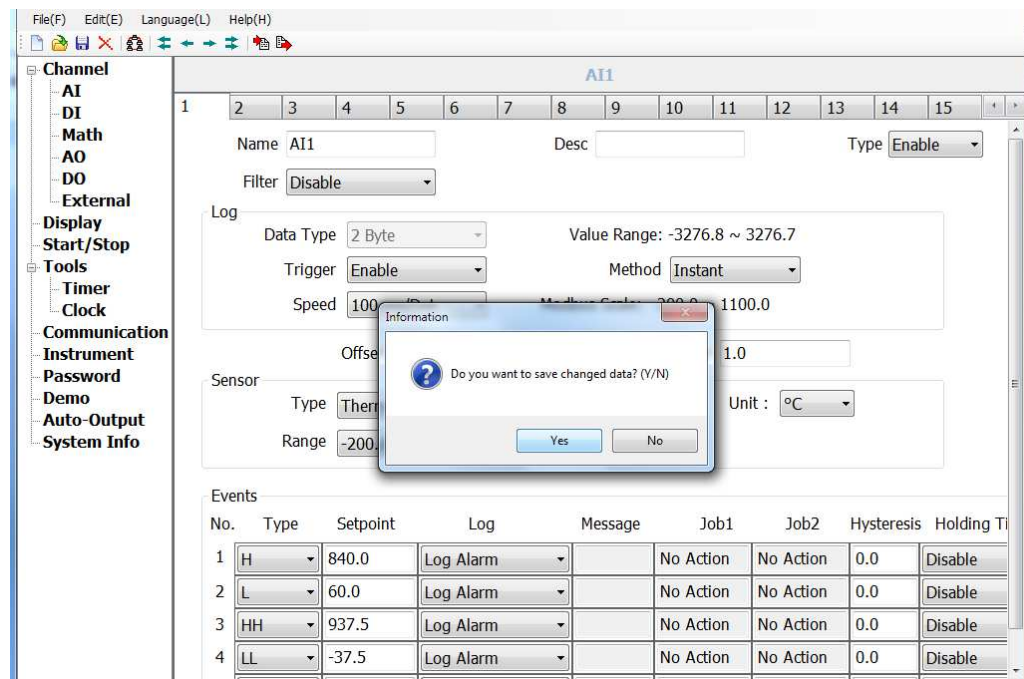

It will navigate to historical viewer screen, click yes for the import of data

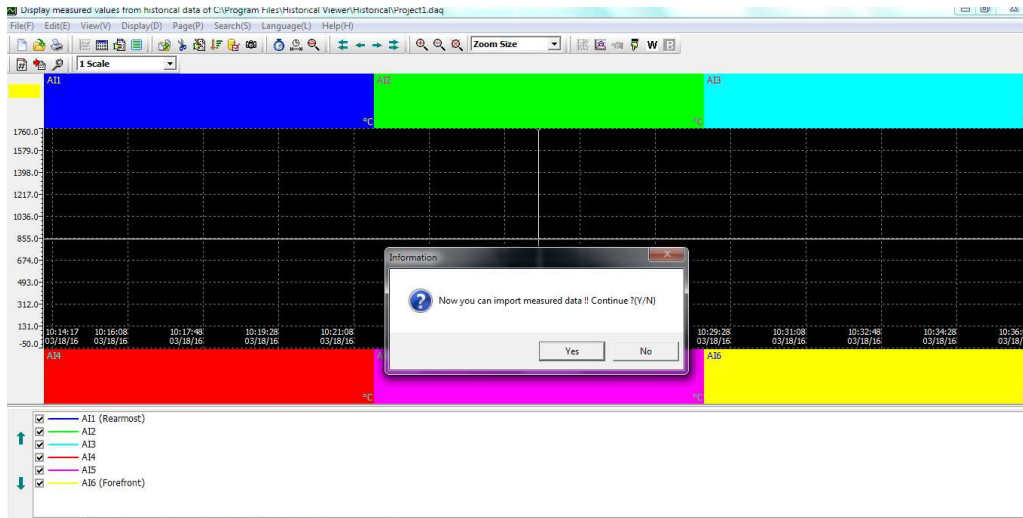

The import starts,

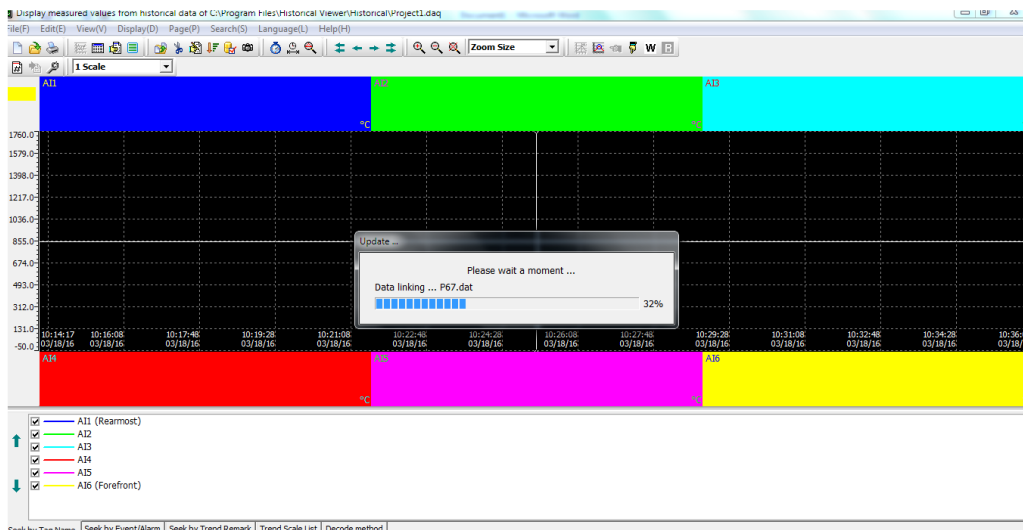

Once done, it will ask to your selection to delete storage media data, in this select No.



Then you can view the data as below

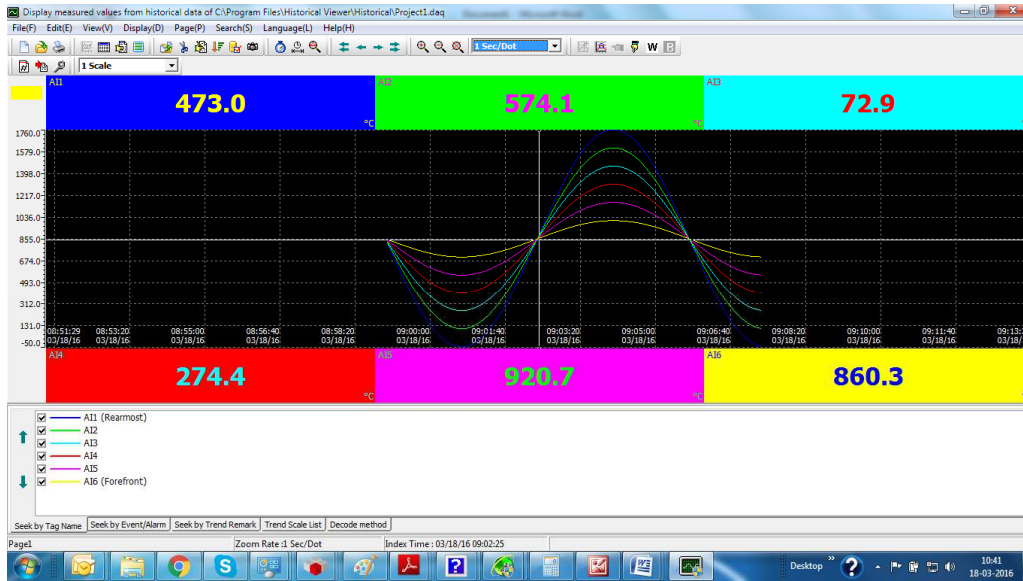

5.1.5 Automatic export of data from historical viewer

In the Historical Viewer after opening the project . Please follow the steps for automatic import

1. Please select Automatically import and export option as shown in the picture.

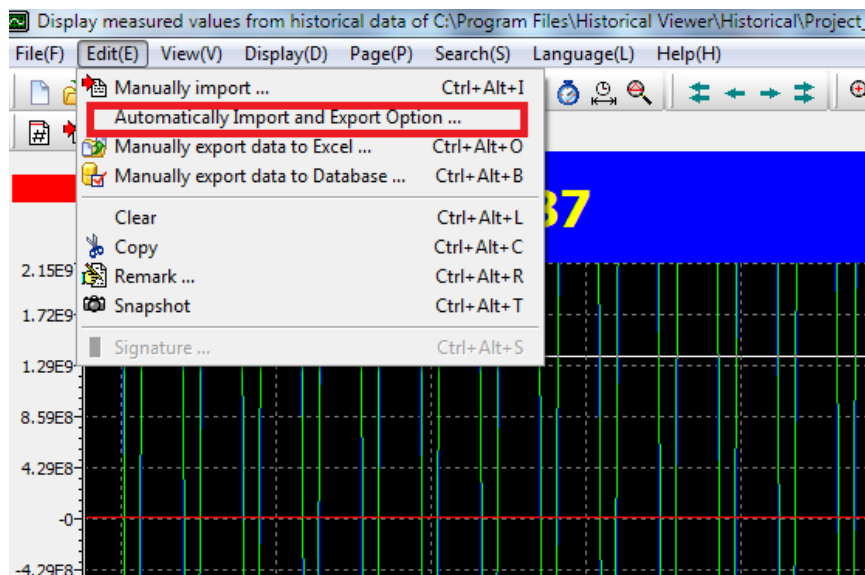

2. Please do the settings as explained in the below picture for the period and also select the path for data dump

Select the period when want the automatic output

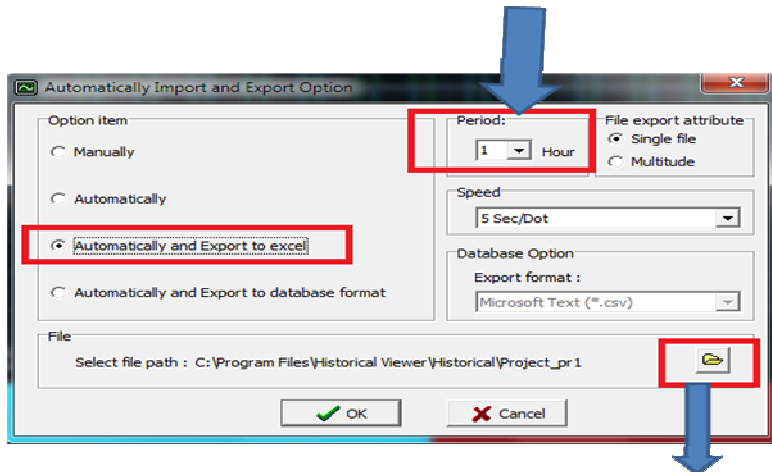

Select the path of the file where you want the data to be dumped

5.2 Data Acquisition Studio Software

5.2.1 Requirements

Hardware

Recommended hardware

PC with 2 GHz processor, 1GB RAM

50GB free space in the hard disk.

Ethernet port, RJ 45 female/ USB port

Minimum 20% free space in hard disk, Less than 10% space generates error message

Operating system



Windows based Operating systems, Windows XP, Windows 7, Windows 8 etc..

32 bit and 64 bit operating systems are supported.

5.2.2 Software

Software installation

1. Install latest dotNet software from Microsoft website
2. Install Data Acquisition Studio software

 Historical viewer icon and  Real time viewer icon, desktop shortcut will be created after installation of software

Historical viewer can be accessed from the following path as well
Start-Programs-Historical viewer-Historical viewer

Real time viewer can be accessed from the following path as well
Start-Programs-Data Acquisition Studio Realtime viewer

5.2.3 How to configure Communication Bank

It is to set path for the data transfer. It's important to setup "Bank" properly at the to proceed further

Open existing Project or create a new project from RealTime viewer using one of the following options

Start-Programs-Data Acquisition Studio-Realtime Viewer



Click on the new Project as shown in the red square in the above figure

Then the User must give a name to the project as shown in the below figure

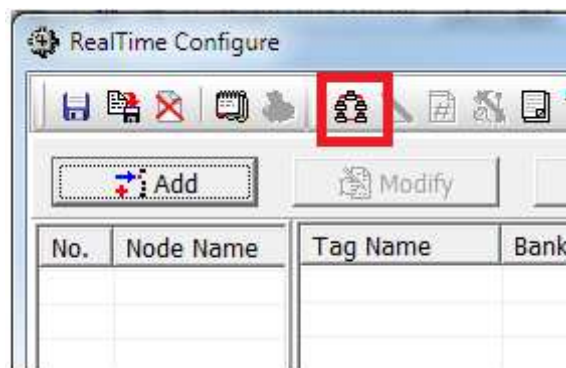

Click the bank icon  to open communication bank configuration, and select the bank accordingly.

Protocol: **Modbus_RS232** ▼

Disable
Modbus_RS232
Modbus_TCP

RS232

Com Port : COM2 ▼

Baud Rate : 9600 ▼

Parity : No ▼

Data Bits : 8 ▼

Stop Bits : 1 ▼

Default

If the recorder is connected to Ethernet, then select Modbus_TCP as shown below

Bank1

Protocol: **Modbus_TCP** ▼

Ethernet

Port : 502

Format : Standard ▼

Default

If the recorder is connected via Serial RS-232 or RS-485, then select Modbus_RS232 as shown below. Please select the same com port and baud rate that is in the instrument.

Bank1

Protocol: **Modbus_RS232** ▼

RS232

Com Port : COM2 ▼

Baud Rate : 9600 ▼

Parity : No ▼

Data Bits : 8 ▼

Stop Bits : 1 ▼

Note : For connecting PR with Realtime Viewer , we suggest to use Ethernet . as Ethernet has better speed compared to RS485/RS232. The Volume of Configuration data in PR is Large comparing to VR. So If you want to connect PR with DAQ using RS485 then you need to follow the below steps :

1. Dump the Configuration file to USB/SD Card from PR
2. Create a new project in Real time Viewer and select the bank with RS485
3. Select the Folder of SD Card/USB where the configuration file was dumped from PR
4. Now the Real time viewer read the configuration file from PR and start monitoring the real time value.

5.2.4 How to configure Recorder

There are three ways to configure the recorder:

Touch screen, Software and Storage Media.

5.2.5 Touch Screen

It is possible to configure the recorder directly from the touch screen.
Press Menu-Config

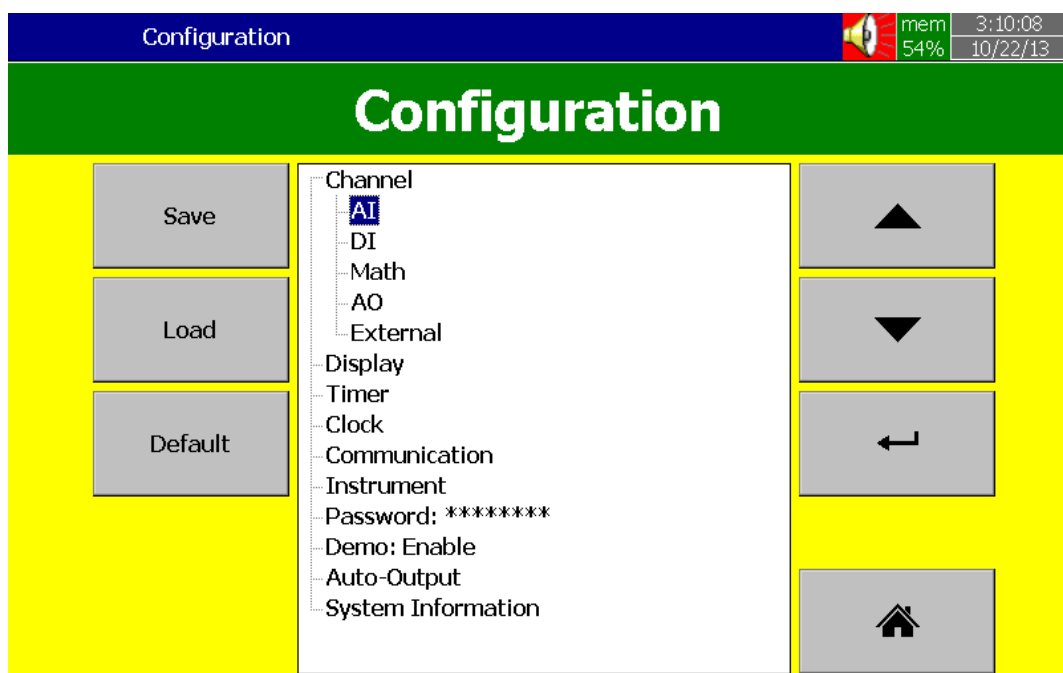

Please refer chapter 4 for more details

5.2.6 Ethernet

The steps are given below

1. Connect Recorder to PC via cross over or straight Ethernet cable
2. Check IP address of your Computer. Make sure to set IP address of Recorder in the same domain as your PC
For ex: IP address of your computer: 192.168.0.200
You may set IP address of Recorder as 192.168.0.11
3. Procedure to set IP address manually at Recorder
Menu-More-Config-Communication, press "Enter"
IP = Select User Define

Select, IP address: 192.168.0.11 (Default) and press “Enter” to change if required

Subnet mask: 255.255.255.0

Default Gateway: 192.168.0.1

4. Use “Ping” from DOS prompt and check if communication is ok or not. If there is no response, check the cable or IP address at your computer or IP address at the recorder

```
C:\ Command Prompt
Microsoft Windows XP [Version 5.1.2600]
(C) Copyright 1985-2001 Microsoft Corp.
E:\Documents and Settings\Mahi>ping 192.168.0.11
Pinging 192.168.0.11 with 32 bytes of data:
Reply from 192.168.0.11: bytes=32 time<1ms TTL=128
Reply from 192.168.0.11: bytes=32 time<1ms TTL=128
Reply from 192.168.0.11: bytes=32 time<1ms TTL=128
Reply from 192.168.0.11: bytes=32 time<1ms TTL=128
Ping statistics for 192.168.0.11:
    Packets: Sent = 4, Received = 4, Lost = 0 (0% loss),
    Approximate round trip times in milli-seconds:
        Minimum = 0ms, Maximum = 0ms, Average = 0ms
E:\Documents and Settings\Mahi>_
```

5. Double click the Realtime viewer icon  at desktop and follow on screen instructions to create a new project

Note: Create a new project only if it's first time. Next time, you can

open  the saved project available in your computer

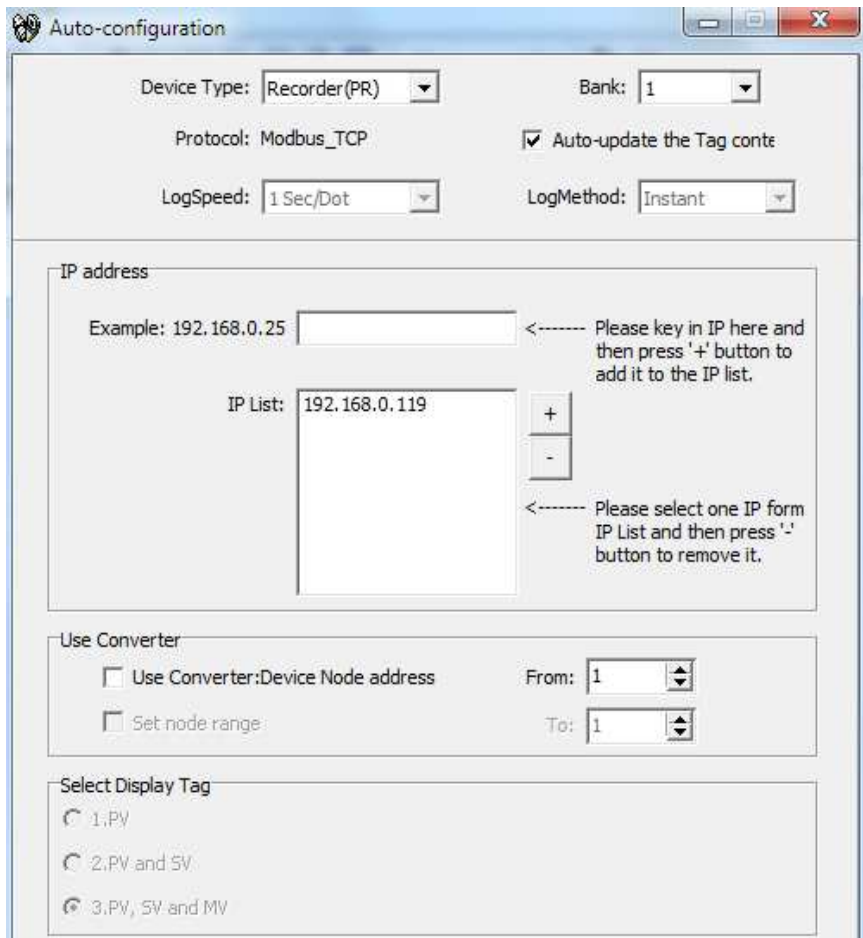

If the connection is working fine, the user can see the below figure. Upon clicking the icon shown in the red box, you are accepting the configuration

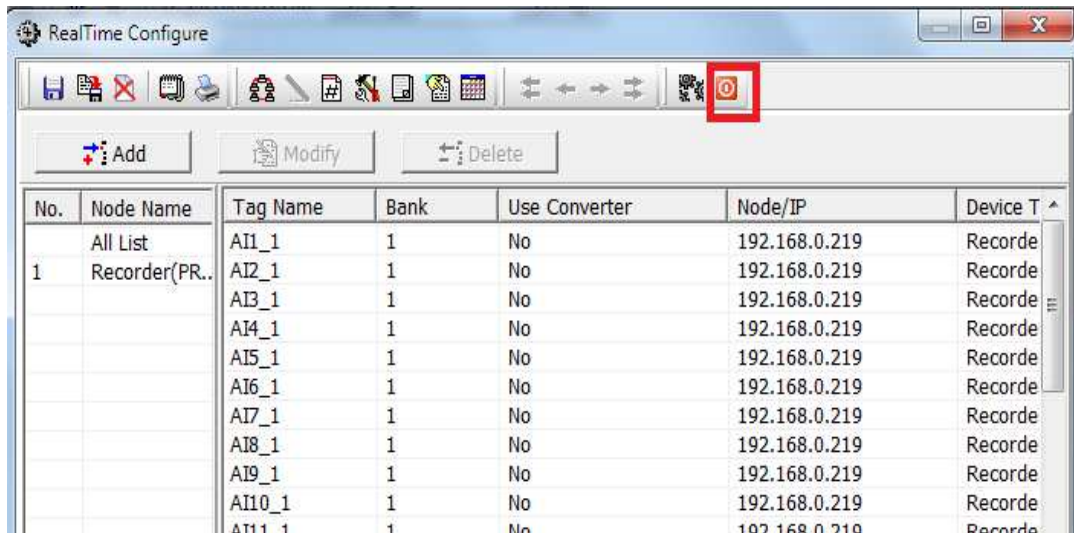

Click yes to apply the settings.

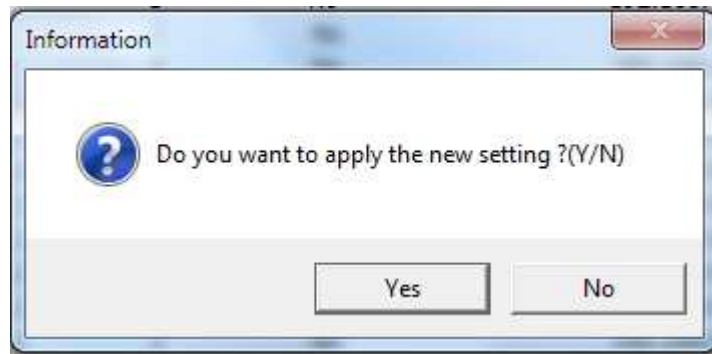

If you have set no password just click ok



And after that you will see the below figure

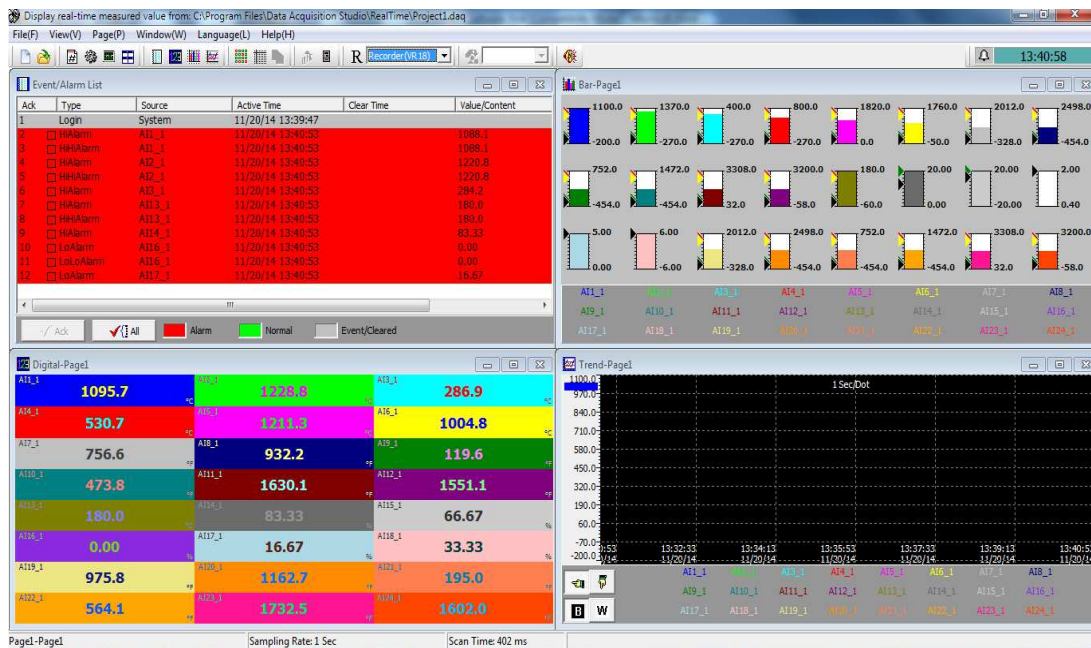

5.2.7 Removable Media

The steps are given below

1. In recorder, please insert an empty SD card or USB stick
2. In the recorder, press “Menu-More-Config”. Press “Save”

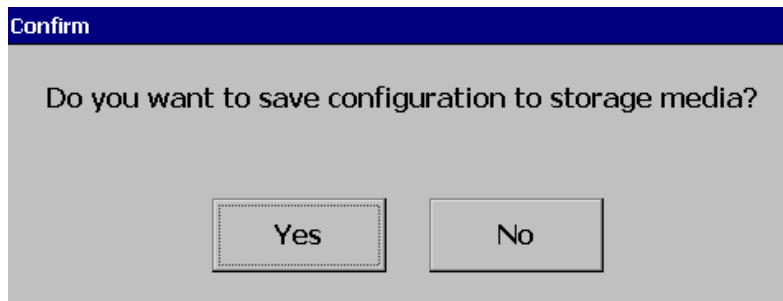
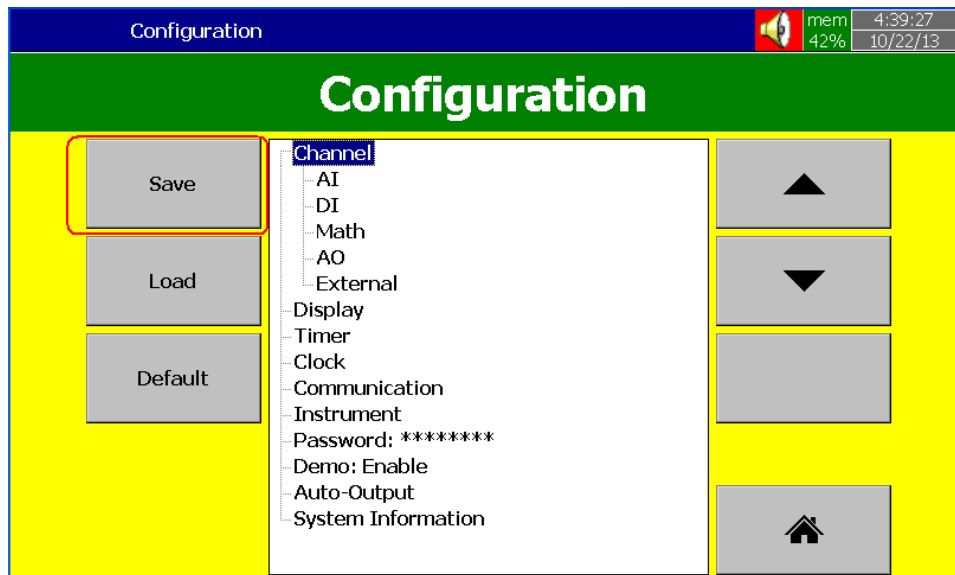

Press “Yes”. It will save Recorder configuration files into USB stick.

Check contents of removable media. It should have the following files

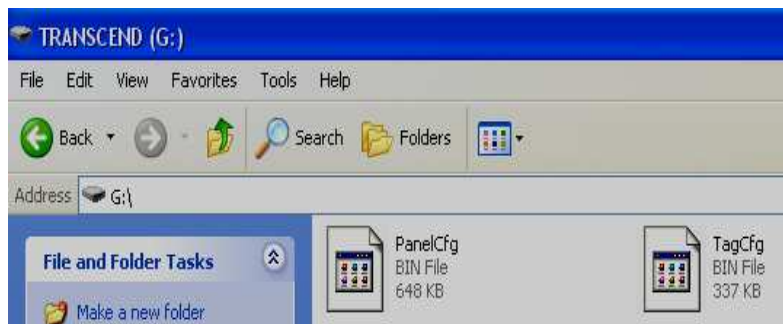

3. Remove the removable media from the recorder. Insert into PC

4. Double click the historical viewer icon  at desktop and follow on-screen instructions to create a new project

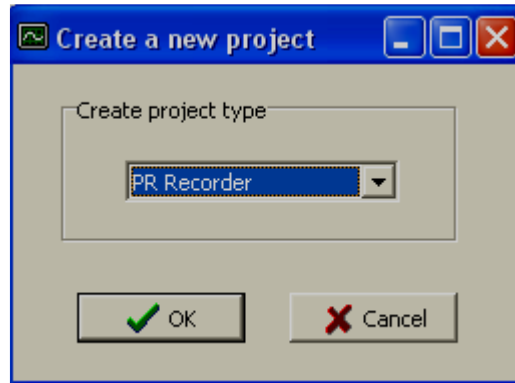

Select PR Recorder. Click “OK”

Note: Above screen appears right away if no project files available in Computer

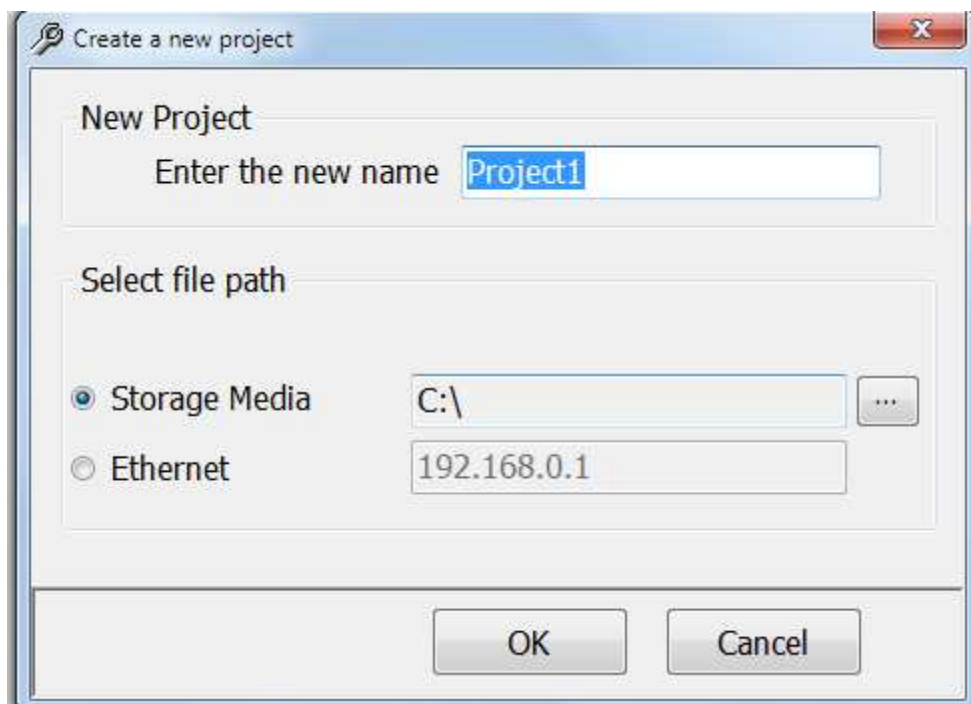

Select “Storage Media”. Then enter the path to the Recorder files in USB stick or SD card. Click “OK”

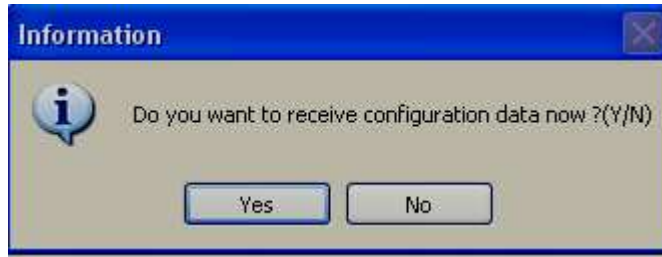

Click “Yes”. It will open Recorder configuration screen

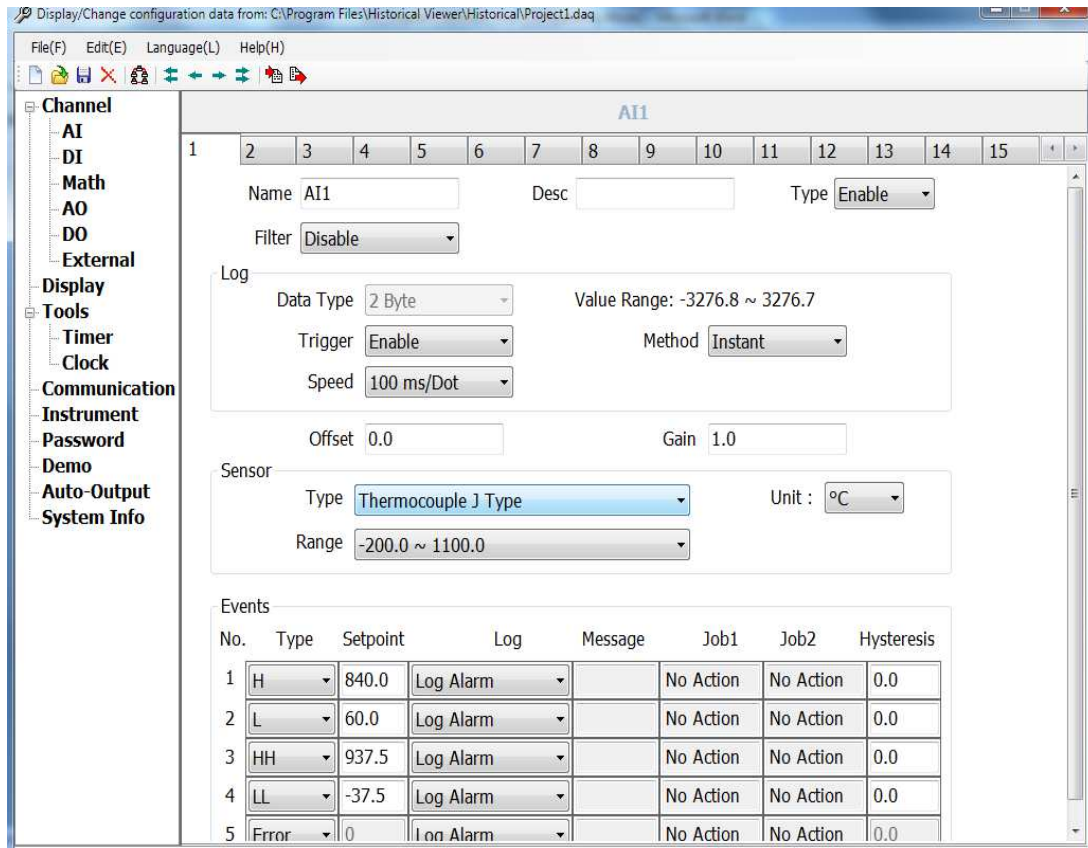

Note: The configuration screen is the same as the screen available directly in recorder. Please refer to Chapters 3 & 4 for more details about configuration

- Do your required changes in the configuration. Click at Send configuration icon 



6. Now, remove your removable media from the PC. Insert it into the Recorder. In the recorder, press "Menu-More-Config".

Press "Load"

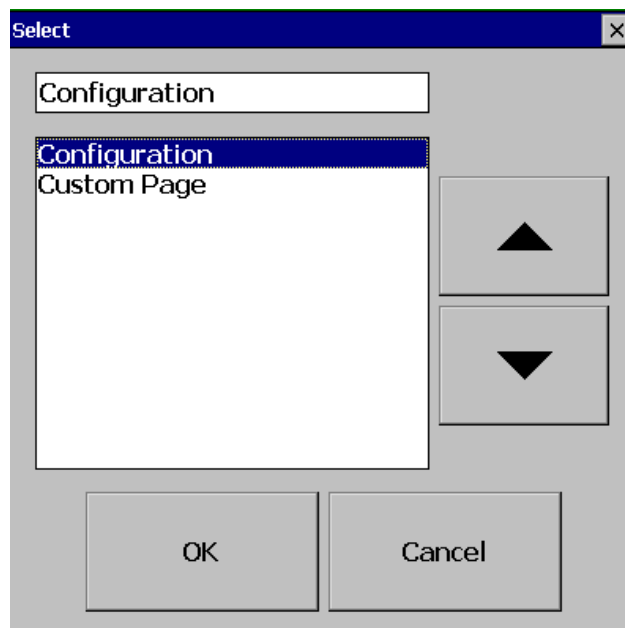
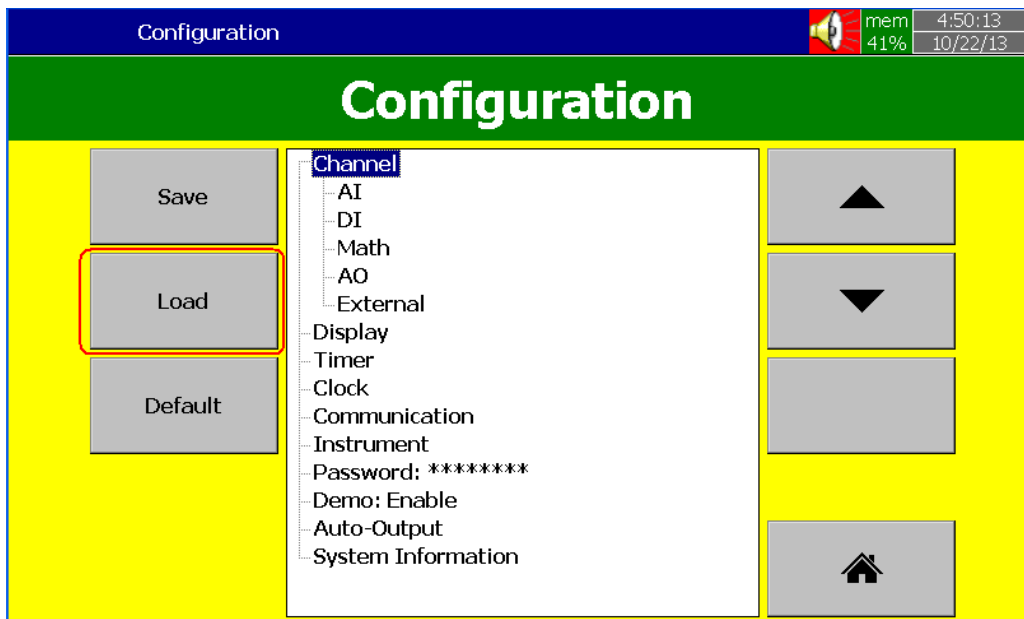

Press "OK"

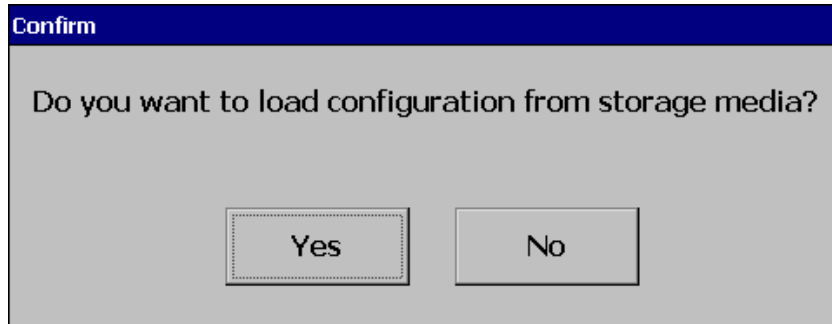

Press "Yes"

5.2.8 Configuration

Please refer to Chapter 4 for full details related to configuration

5.2.8.1 Analog Input

The screenshot shows the configuration interface for channel AI1. On the left is a navigation tree with categories: Channel, AI (selected), DI, Math, AO, DO, External, Display, Tools, Timer, Clock, Communication, Instrument, Password, Demo, Auto-Output, and System Info. The main area is titled "AI1" and contains the following settings:

- Name:** AI1
- Desc:** (empty)
- Type:** Enable
- Filter:** Disable
- Log:**
 - Data Type: 2 Byte
 - Value Range: -3276.8 ~ 3276.7
 - Trigger: Enable
 - Method: Instant
 - Speed: 100 ms/Dot
- Sensor:**
 - Offset: 0.0
 - Gain: 1.0
 - Type: Thermocouple J Type
 - Unit: °C
 - Range: -200.0 ~ 1100.0
- Events:**

No.	Type	Setpoint	Log	Message	Job1	Job2	Hysteresis
1	H	840.0	Log Alarm		No Action	No Action	0.0
2	L	60.0	Log Alarm		No Action	No Action	0.0
3	HH	937.5	Log Alarm		No Action	No Action	0.0
4	LL	-37.5	Log Alarm		No Action	No Action	0.0
5	Error	0.0	Log Alarm		No Action	No Action	0.0

5.2.8.2 Digital Input

Channel

- AI
- DI**
- Math
- AO
- External
- Display
- Tools
 - Timer
 - Clock
- Communicati
- Instrument
- Password
- Demo
- Auto-Output
- System Info

DI1

1 2 3 4

Name: DI1

Desc: Tank level high

Type: Logic Level

Events

No.	Type	Log	Message	Job1	Job2
1	Disab	No Action		No Action	No Action
2	Disab	No Action		No Action	No Action

5.2.8.3 Math channel

Channel

- AI
- DI
- Math**
- AO
- External
- Display
- Tools
 - Timer
 - Clock
- Communicati
- Instrument
- Password
- Demo
- Auto-Output
- System Info

Math1

1 2 3 4 5 6 7 8 9 10 11 12

Name: Math1

Desc: Totalizer 6

Type: Math

Log

Data Type: 4 Byte

Value Range: -3.4E+38 ~ 3.4E+38

Trigger: Enable

Method: Instant

Speed: 100 ms/Dot

Expression: (AI1+AI2)/2

Scale

Unit:

Transformation: Value

Decimal: 0

Table: Point 1 to 2

Range: 0 ~ 10

Events

No.	Type	Setpoint	Log	Message	Job1	Job2	Hysteresis
1	H	0	No Action		No Action	No Action	0
2	Disab	0	No Action		No Action	No Action	0
3	Disab	0	No Action		No Action	No Action	0
4	Disab	0	No Action		No Action	No Action	0
5	Disab	0	No Action		No Action	No Action	0

5.2.8.4 Analog Output

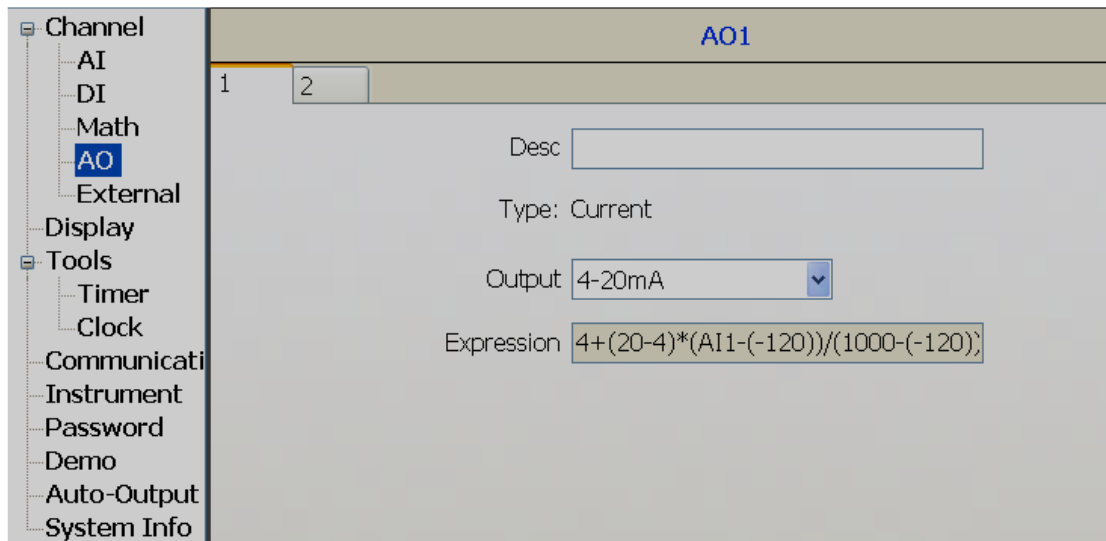

5.2.8.5 External Channel

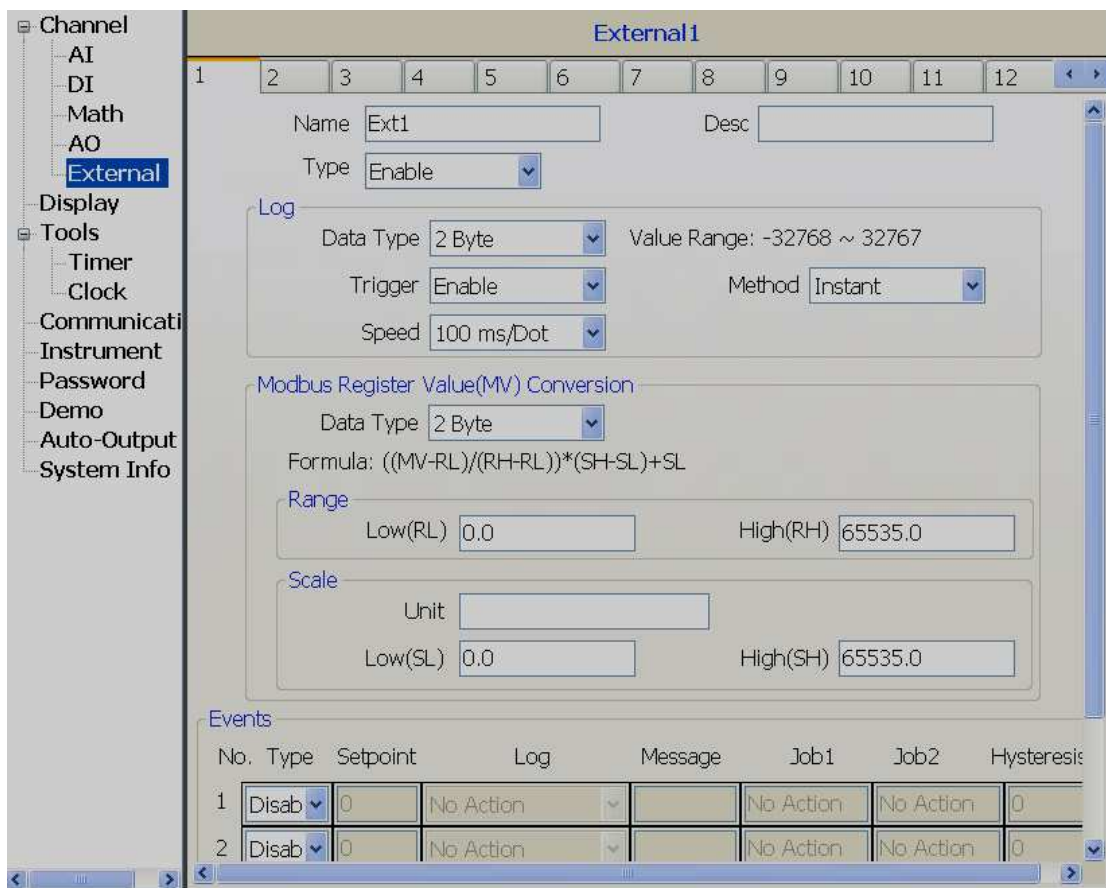

5.2.8.6 Display

Display1

Name: Page1 Mode: Trend Direction: Horizontal

Speed: 1 Sec/Dot Background: Black

No.	Channel	Color	Width	Display Low	Display High
1	AI1	Blue	1	-120.0	1000.0
2	AI2	Lime	1	-200.0	1370.0
3	AI3	Cyan	1	-250.0	400.0
4	AI4	Red	1	-100.0	900.0
5	AI5	Magenta	1	0.0	1820.0
6	AI6	Yellow	1	0.0	1767.8
7	AI7	Gray	1	0.0	1767.8
8	AI8	Dark Blue	1	-250.0	1300.0

Status Bar

Type: Disable

1. Disable 2. Disable 3. Disable 4. Disable
 5. Disable 6. Disable 7. Disable 8. Disable

5.2.8.7 Timer

Timer1

Type: Daily Action: Enable

Time

Day: 1 Hour: 8 Min: 0 Sec: 1

Events

Job1: Print Report List
 Job2: No Action

5.2.8.8 Clock

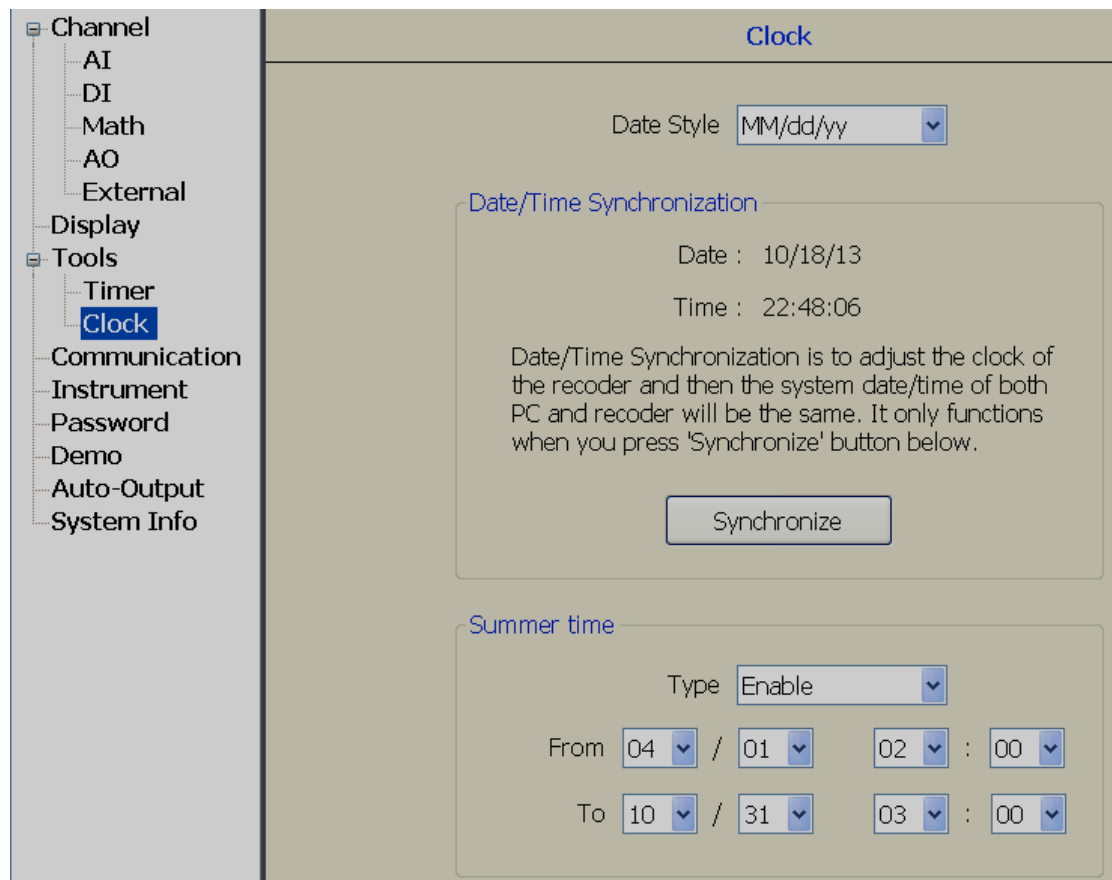

5.2.8.9 Communication

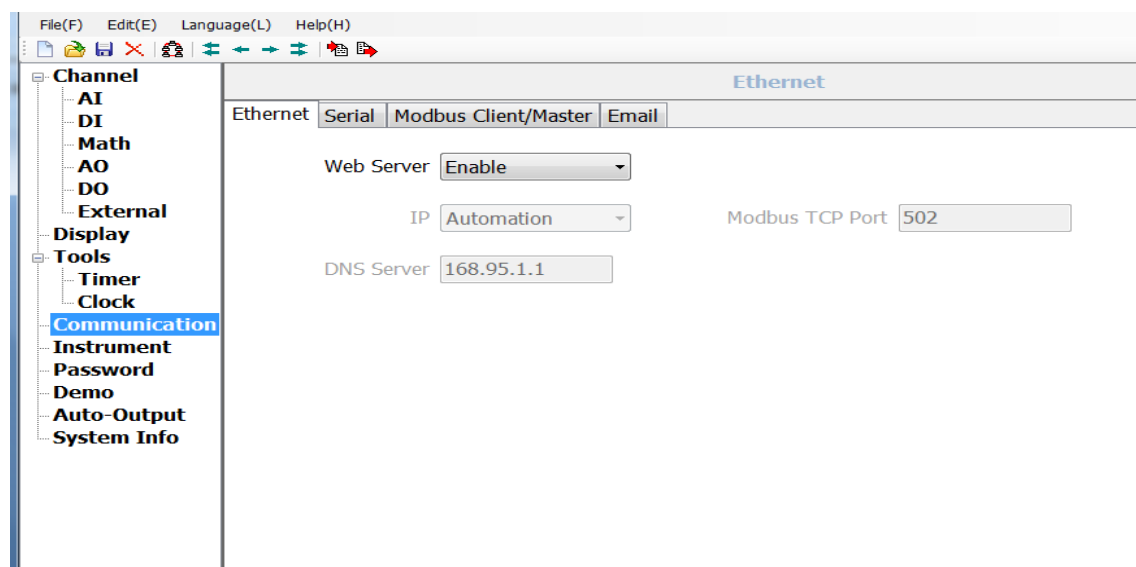

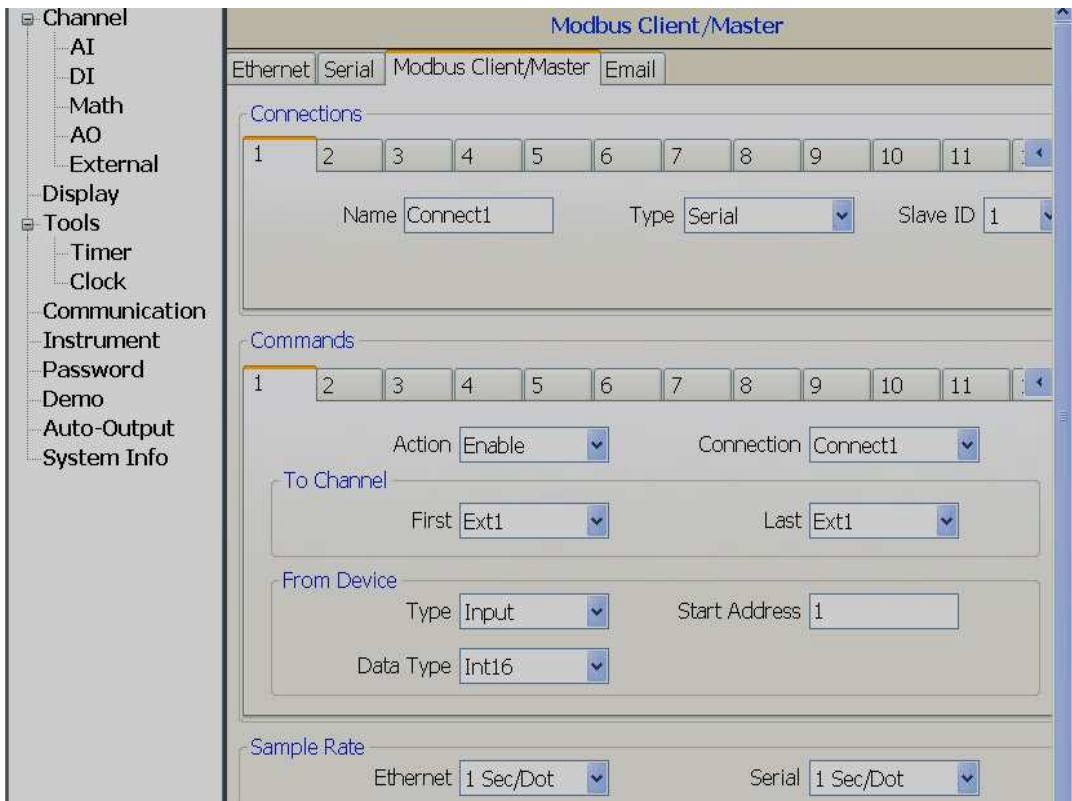
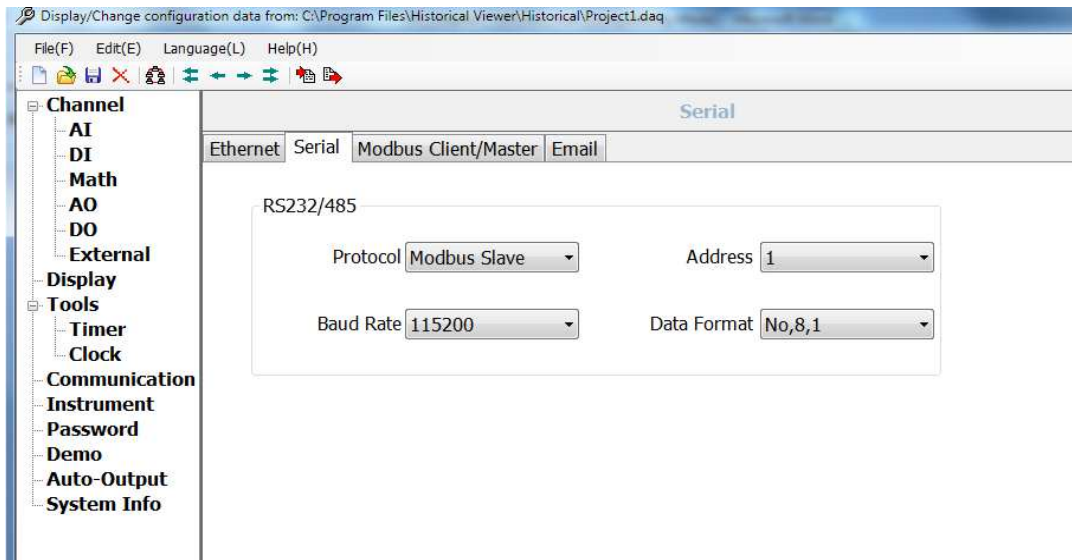

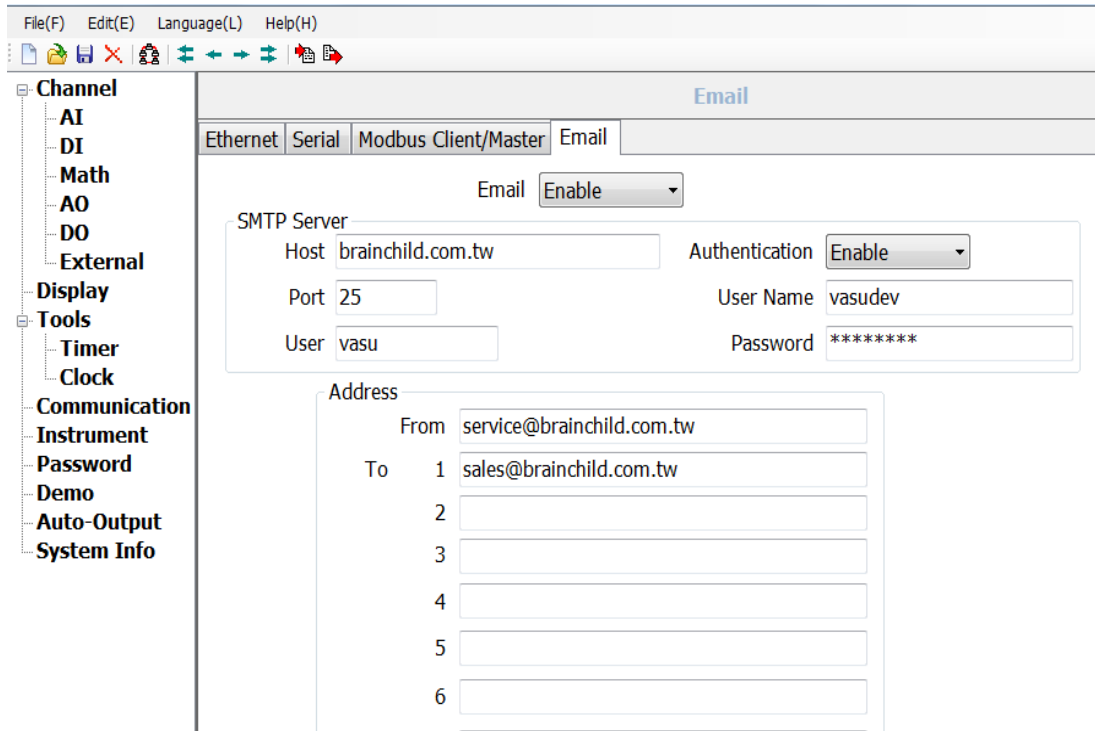

5.2.8.10 Instrument

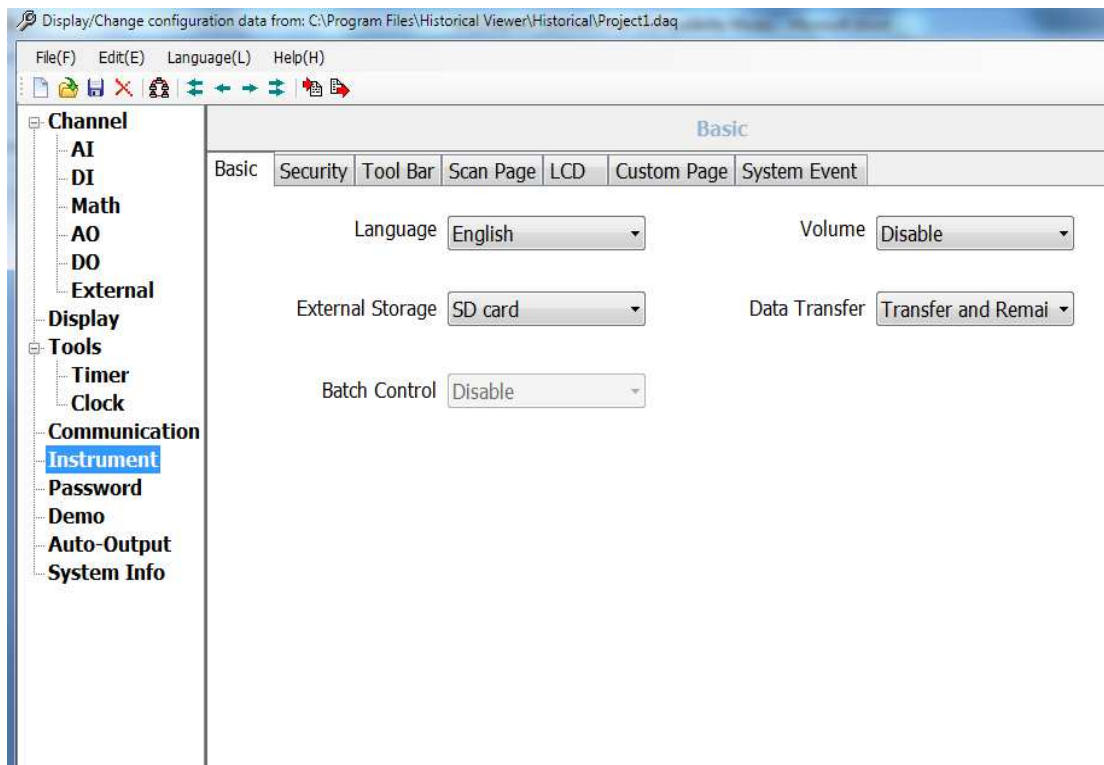

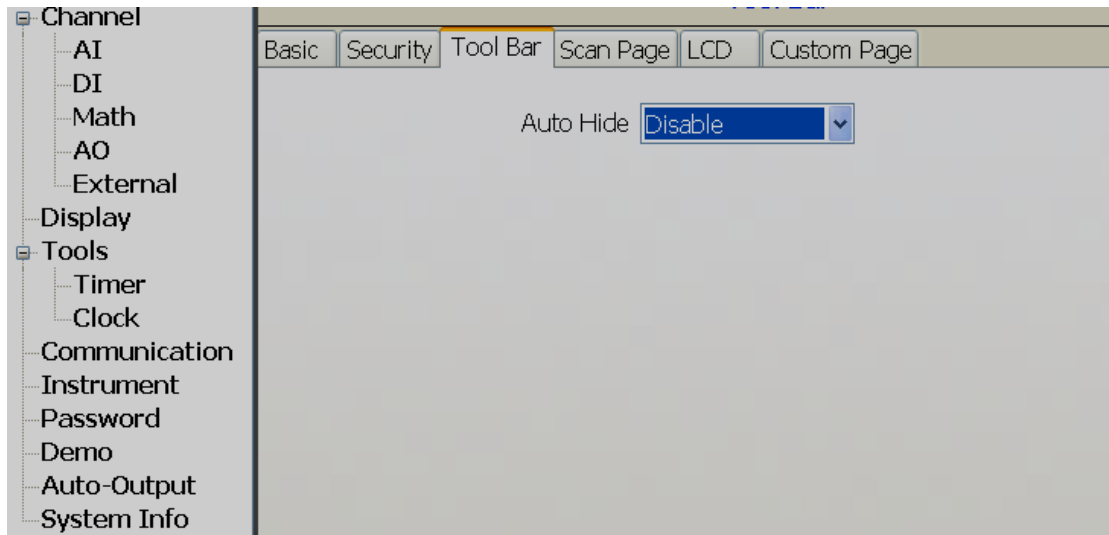
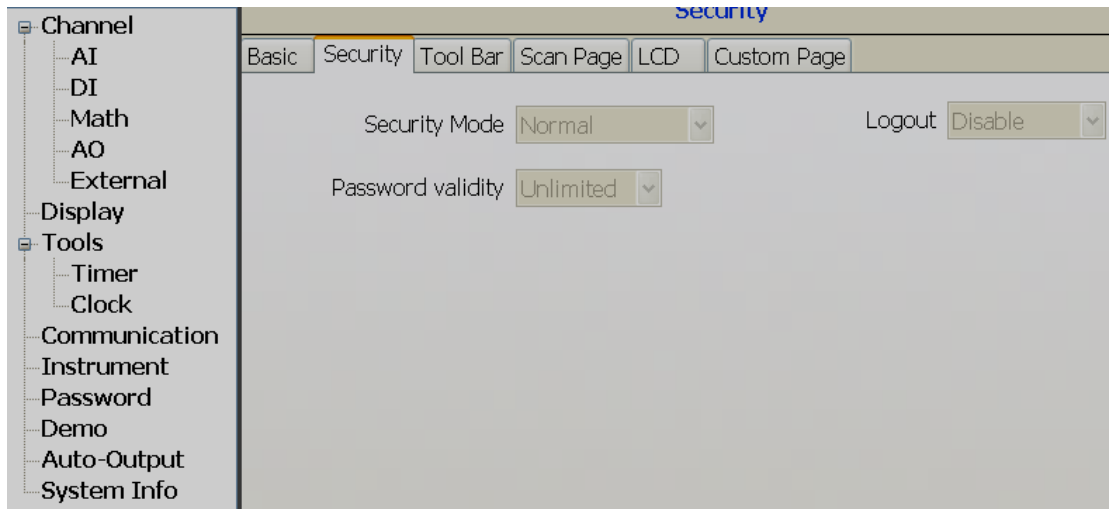

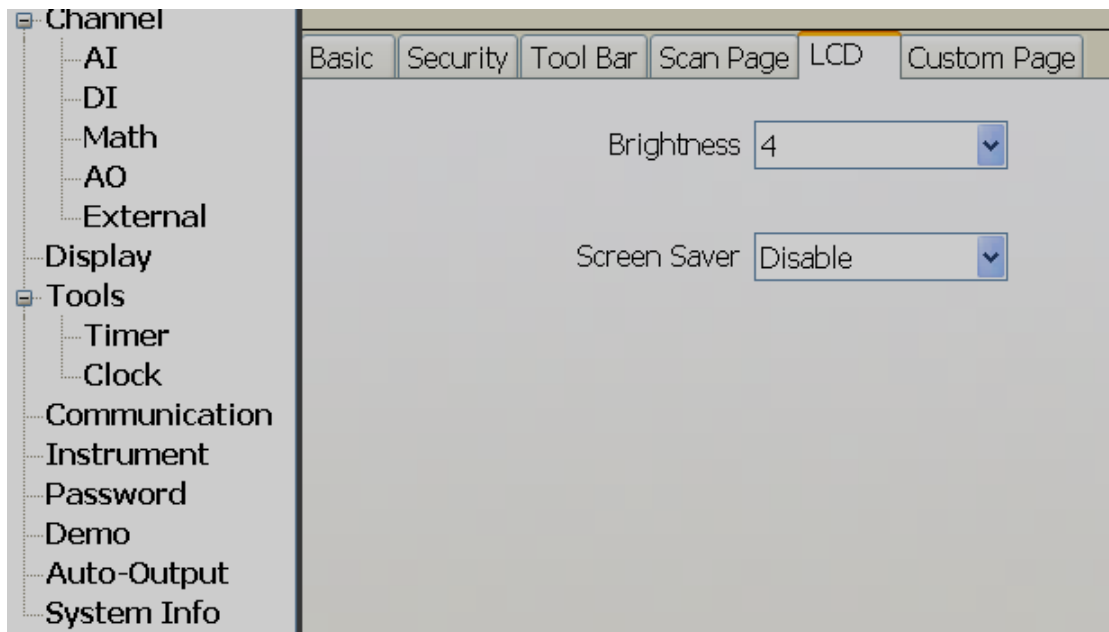
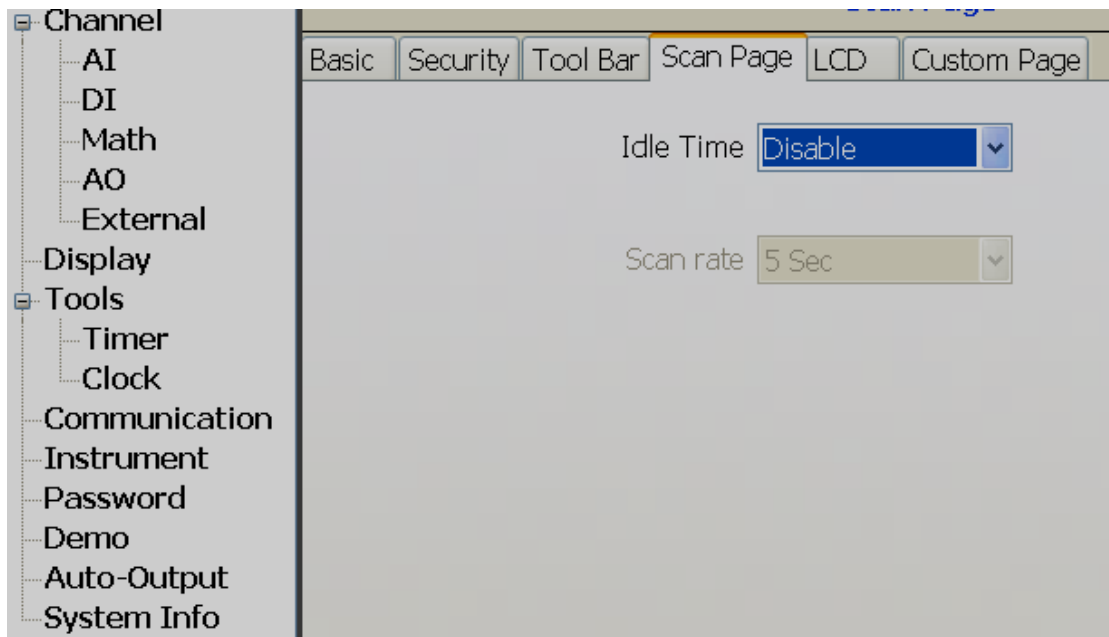

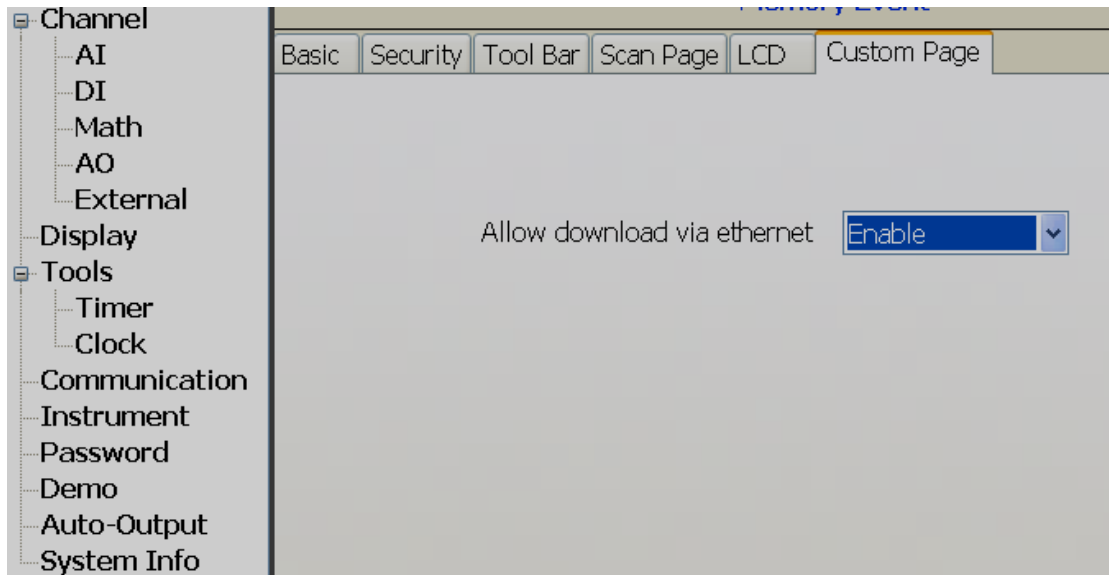

5.2.8.11 Password

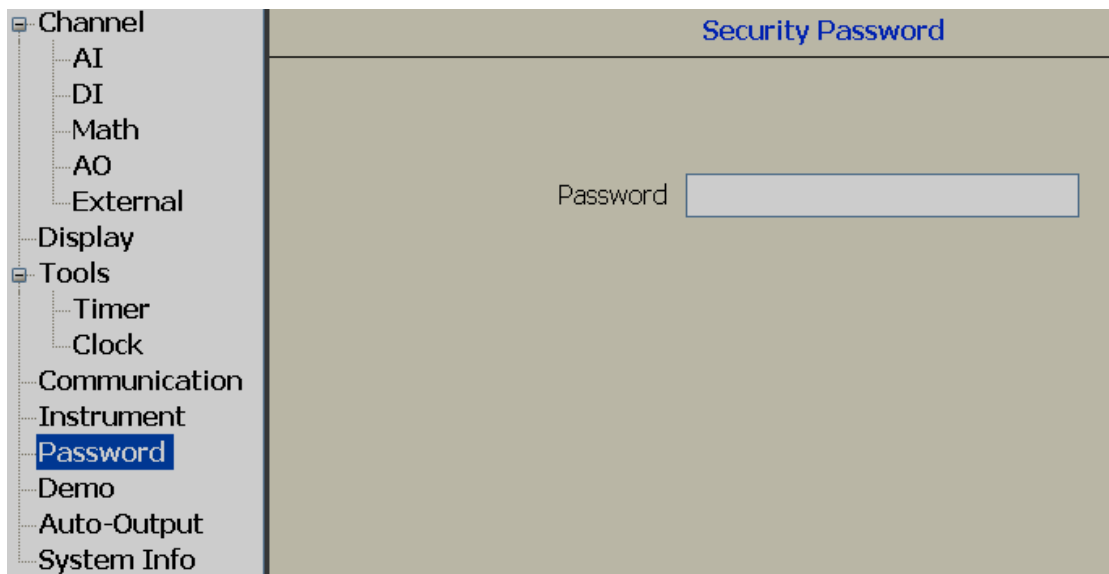

5.2.8.12 Demo

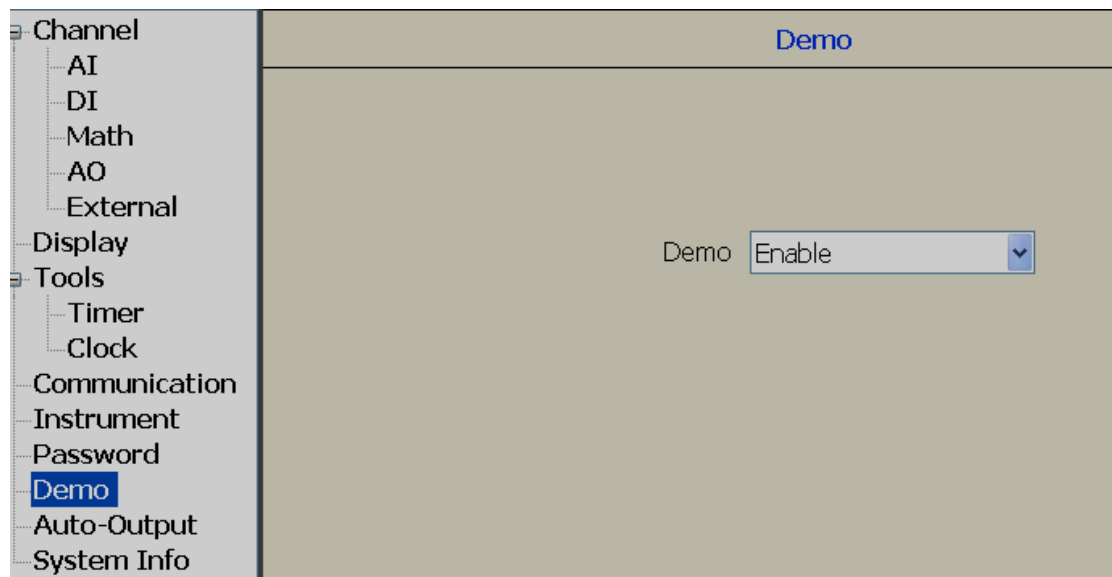

5.2.8.13 Auto-Output

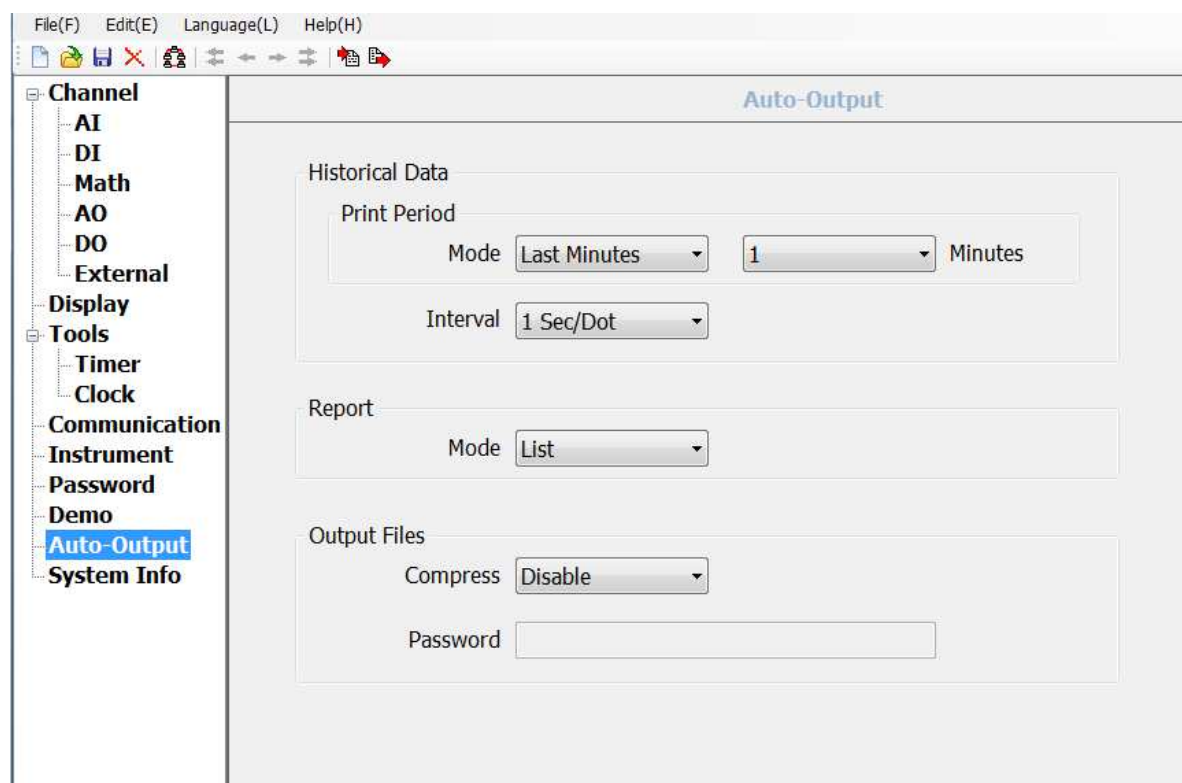

5.2.8.14 System Information

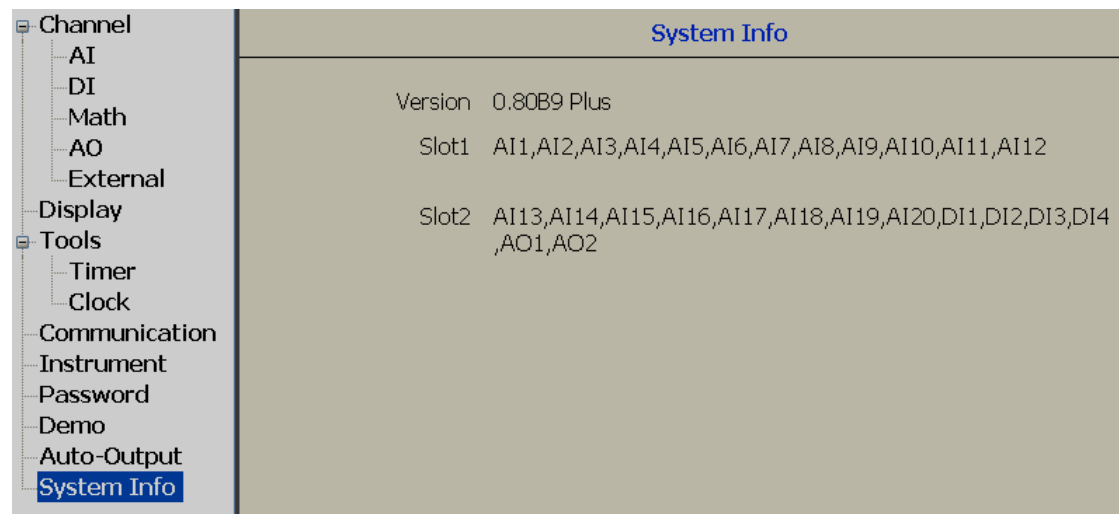

5.2.9 How to view Historical data

There are three ways to view Historical Data

1. Touch screen
2. Ethernet
3. USB stick

5.2.9.1 Touch Screen

Please refer Chapter 3 for details how to view historical data in directly from the recorder using the touch screen

5.2.9.2 Ethernet

Note: Please read the following sections first

1. How to configure Communication bank
2. How to configure Recorder - Ethernet

Make sure your Project has already been created and saved in your computer. Then set bank to Ethernet before proceeding with the following steps

Open Project from Historical viewer using one of the following options

Desktop: Historical viewer icon 

Start-Programs-Historical viewer-Historical viewer

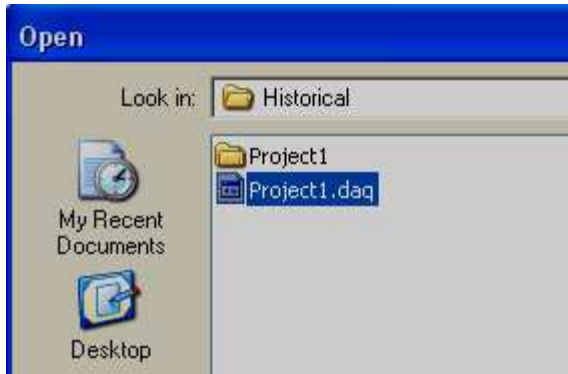

Select Project and click “Open”

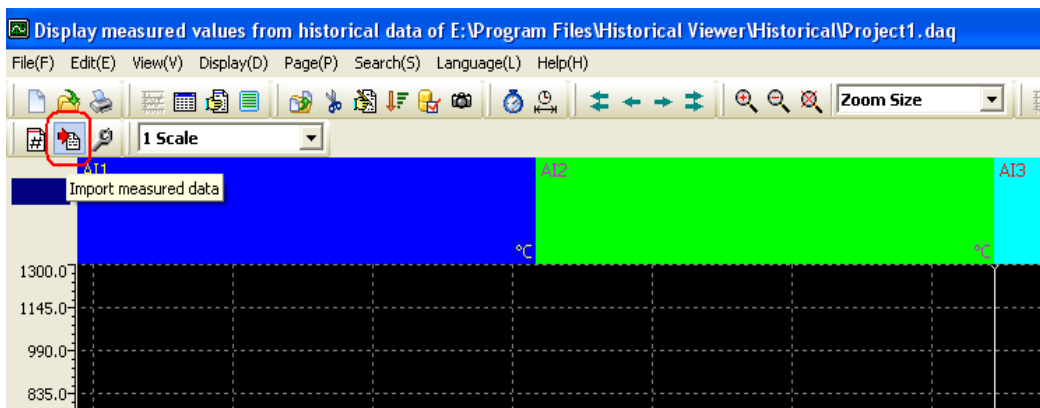

Click Import measured data icon 

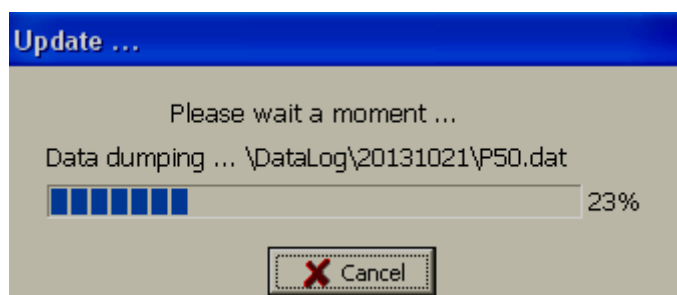

Note: Time taken based on amount of data available in internal memory

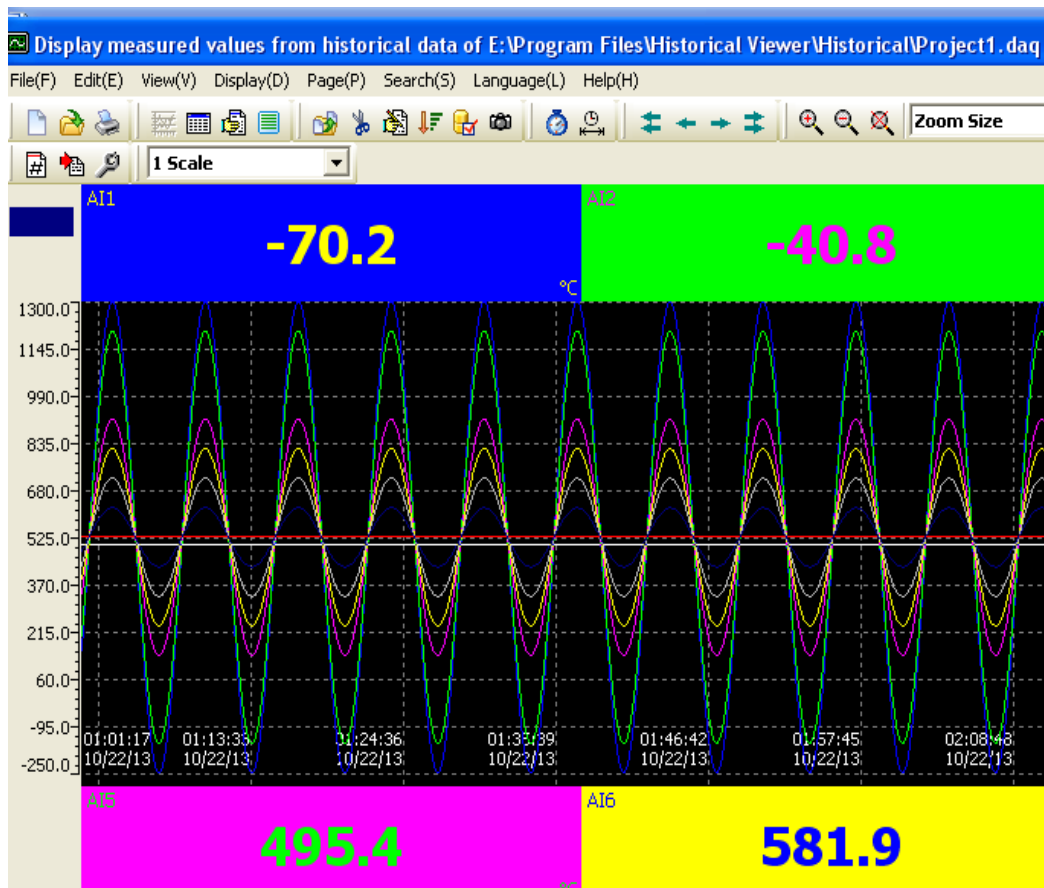

Press anywhere on the trend area, then click at Zoom icon  and then see the historical trend clearly

Note: Please read "Historical viewer" help file from software itself for all the features available in Historical viewer software

5.2.9.3 Removable Media

Note: Please read the following sections first

1. How to configure Communication bank
2. How to configure Recorder viaSD card or USB

Make sure that if a project has already been created, and the settings and data are stored on an SD card or USB, set the bank to "Storage media" before proceeding with the below steps:

Insert Empty - SD card or USB in Recorder

Press "Menu-More-Dump"

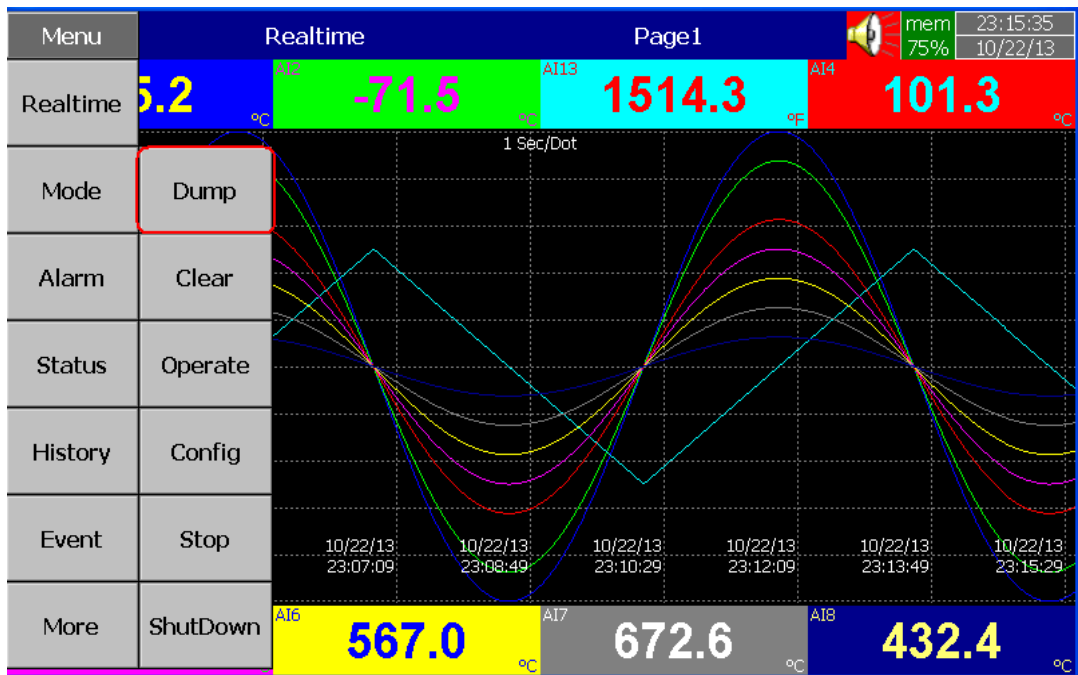

Select

All

All

Initial 1 Day

Initial 2 Days

Initial 3 Days

Initial 4 Days

Initial 5 Days

Initial 6 Days

Initial 7 Days

Initial 8 Days

Initial 9 Days

Initial 10 Days

OK

Cancel

Select "All" or one of the other available options, then press "OK"

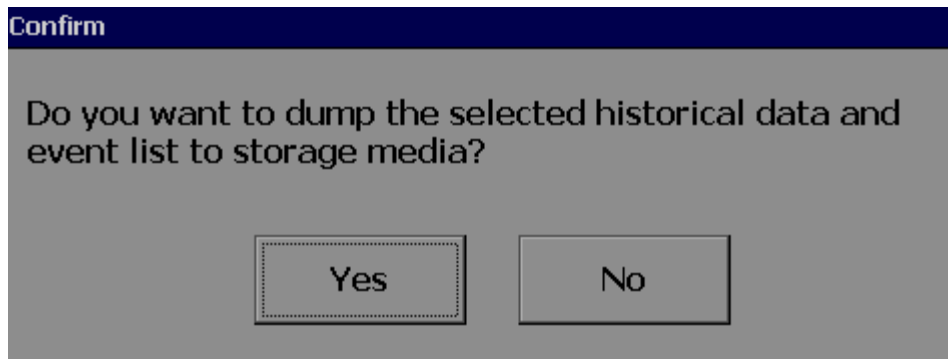

Press "Yes"

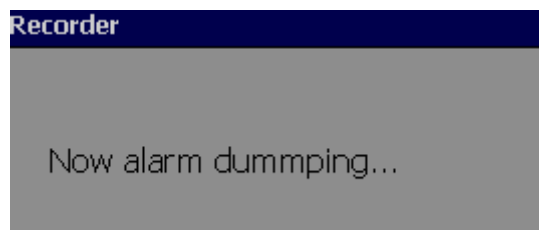

Now, remove USB stick from Recorder

Check contents in the USB stick

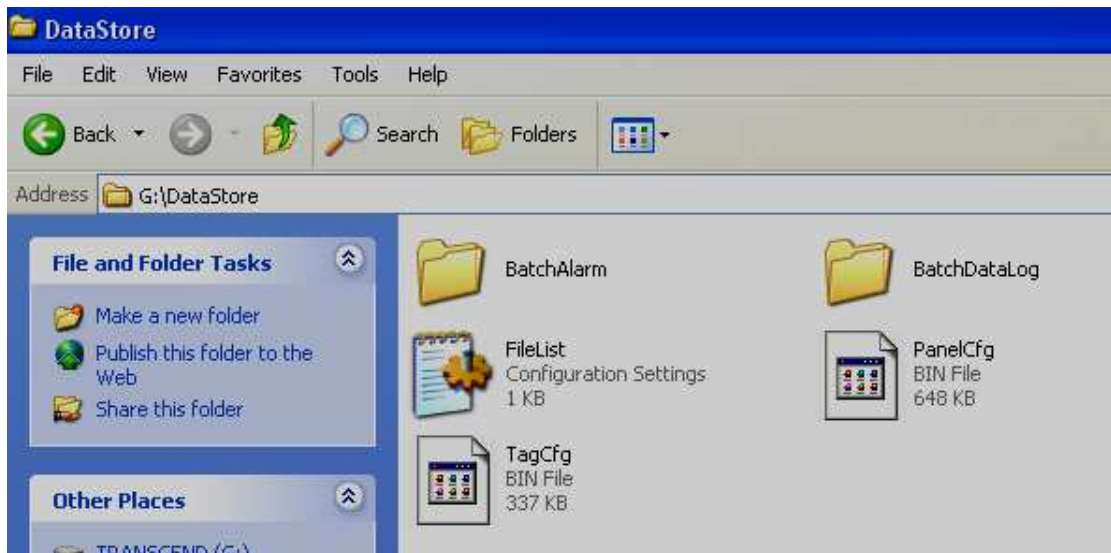

Open Project from Historical viewer using one of the following options

Desktop: Historical viewer icon 

Start-Programs-Historical viewer-Historical viewer



Select Project and click “Open”

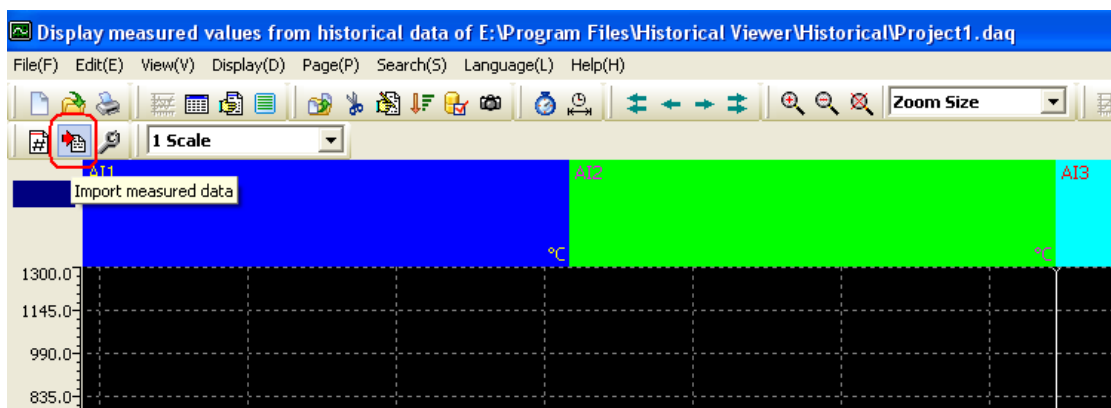

Click Import measured data icon 

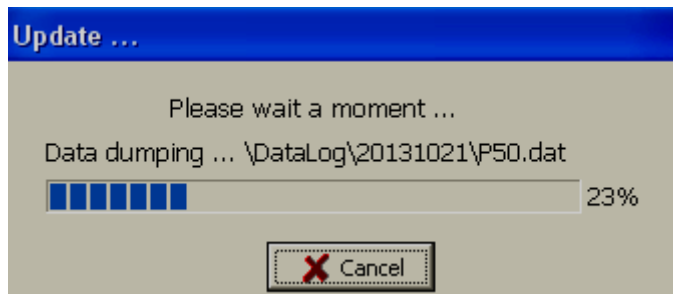

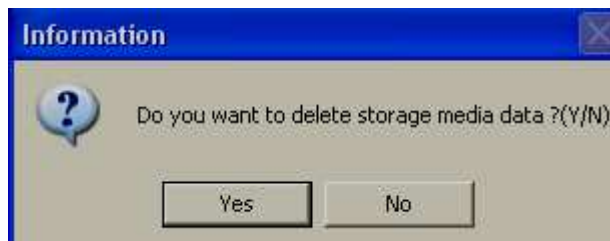
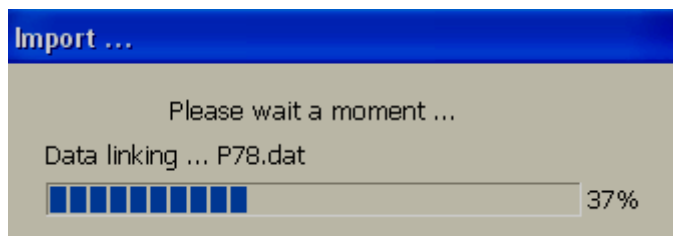

Note: Time taken is based on the amount of data available in internal memory

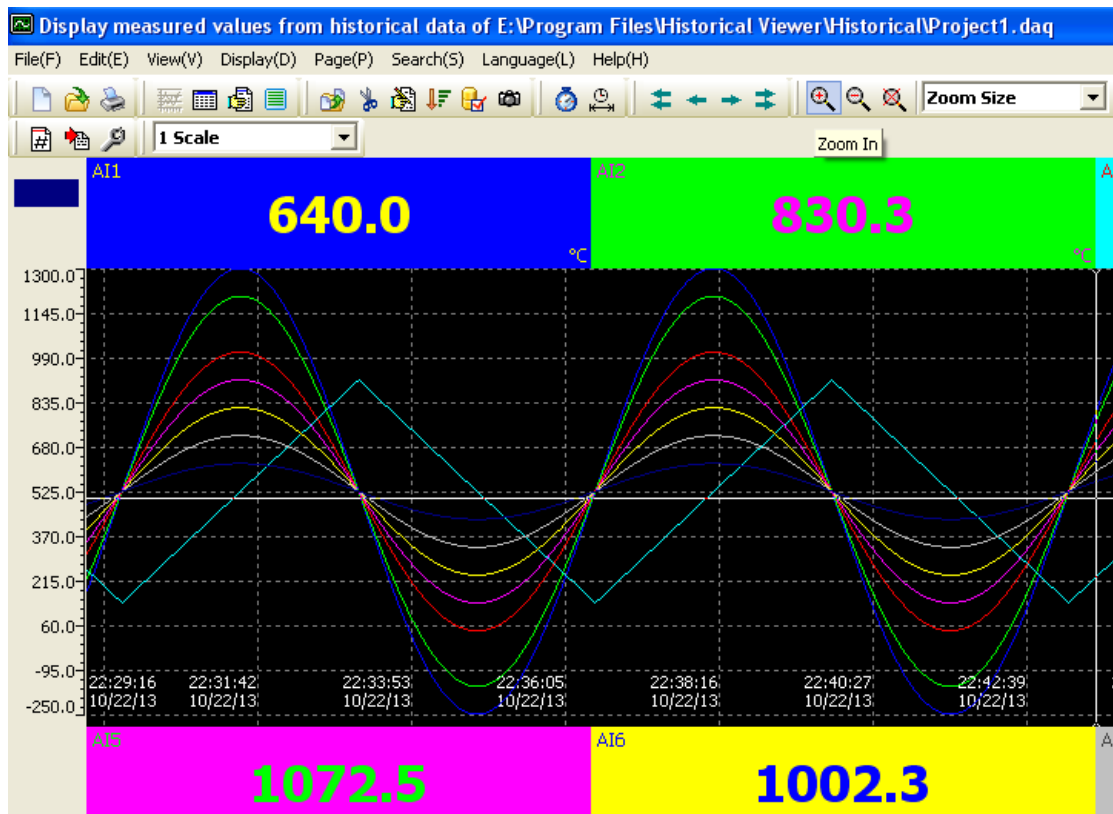

Select "Yes" if you wish to delete data from USB stick.

Select "No" only if you have plans to transfer data to another Computer or if you have plans to maintain data storage as back up in proprietary format in a Computer hard disk



Press on any area of the trend screen, then click at Zoom icon  and then see the historical trend clearly

Note: Please read "Historical viewer" help file from software itself for all the features available in Historical viewer software

5.2.10 How to view Real time data in PC

It is possible to monitor Real time data from paperless recorder on your PC

For this, the recorder should be connected to a PC via Ethernet or Serial network (RS232/422/485). Set bank appropriately to proceed with required option.

5.2.11 Bank configuration

How to open Real time viewer

There are two ways to open Realtime Viewer

Click the desktop icon 

Start-Programs-Data Acquisition Studio Studio-Real time viewer

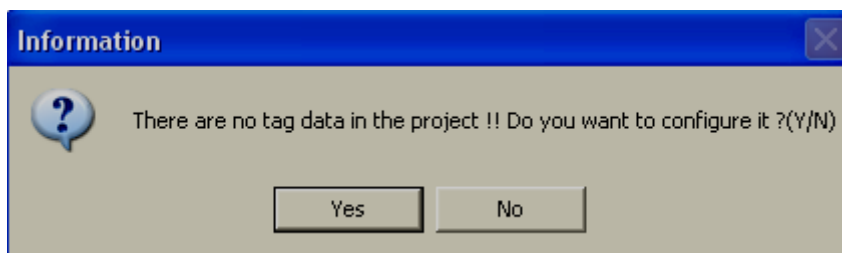
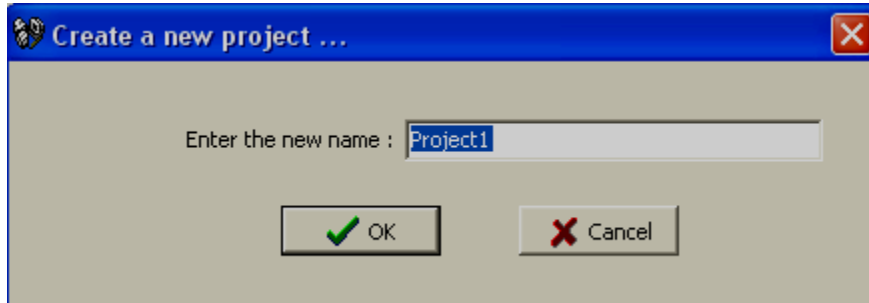

Click "No"

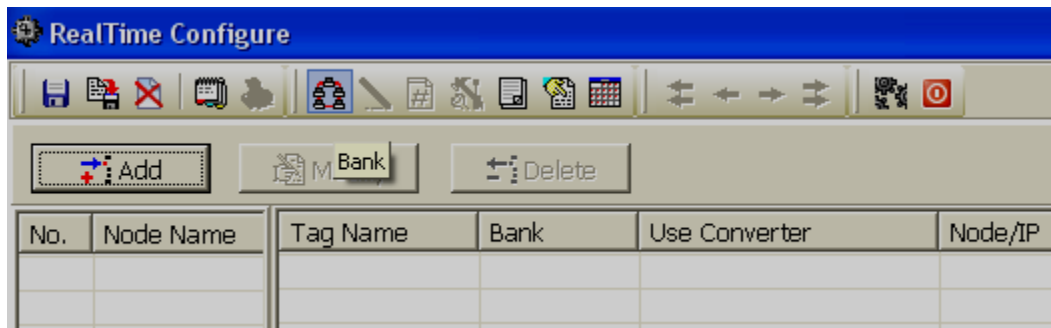

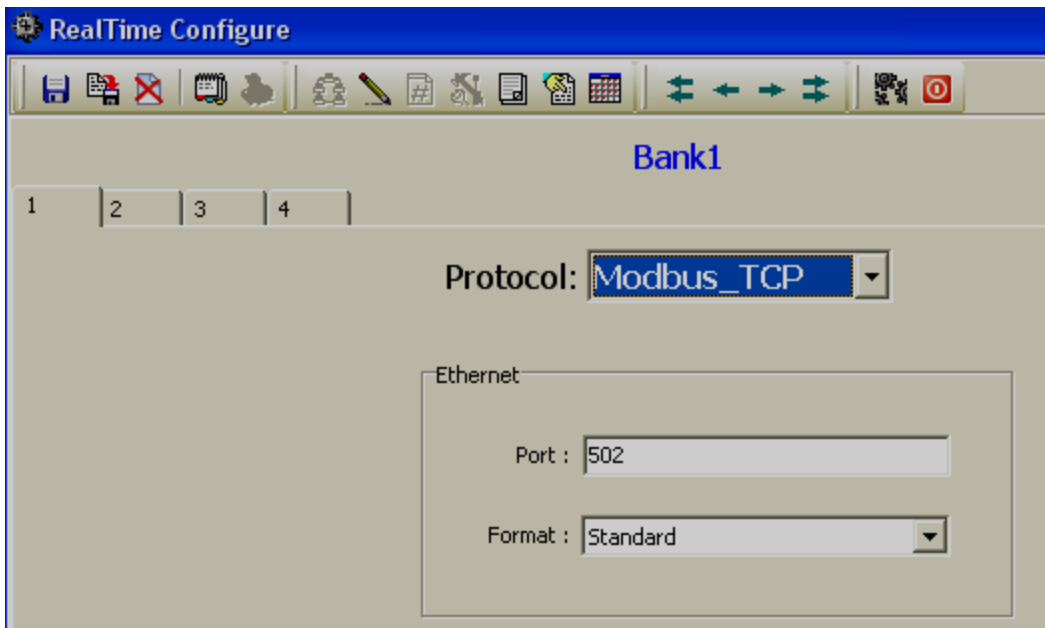

Click bank icon 



A total of 4 communication banks are available

Each bank can be configured as Either Modbus Serial (232/422/485) or Modbus_TCP (Ethernet)

For example: If two Paperless Recorders are coming on two different RS485 networks, then each bank can be configured for each individual Recorder. This is provided that two COM ports are configured in PC to receive data from two different serial networks. You may use two USB to Serial converters for this application (See our UPort1150).

After completing the bank setup, click “Save” icon . To close, click the return to main program icon 

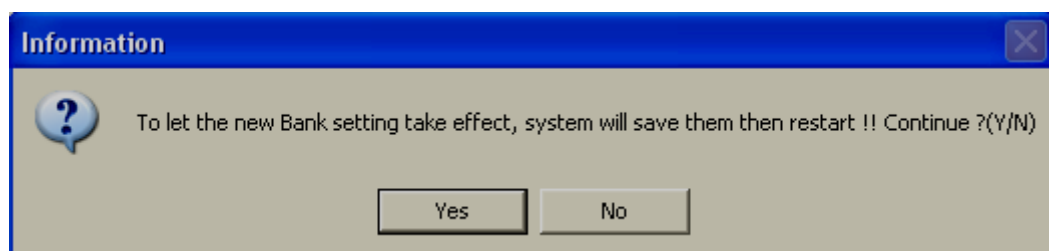

5.2.12 Ethernet

1. Install Data Acquisition Studio software
2. Set bank radial button to Ethernet
3. If the recorder is connected to the PC via Ethernet, make sure recorder is set with a User defined IP address and domain that is the same as the PC

Use Ping instruction from the Dos prompt, make sure the recorder is communicating with the PC via Ethernet

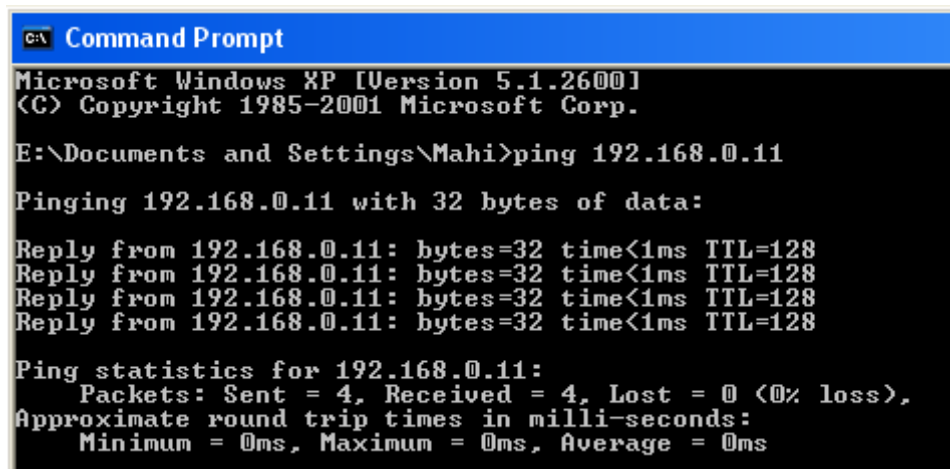

```
C:\> Command Prompt
Microsoft Windows XP [Version 5.1.2600]
(C) Copyright 1985-2001 Microsoft Corp.

E:\Documents and Settings\Mahi>ping 192.168.0.11

Pinging 192.168.0.11 with 32 bytes of data:

Reply from 192.168.0.11: bytes=32 time<1ms TTL=128
Reply from 192.168.0.11: bytes=32 time<1ms TTL=128
Reply from 192.168.0.11: bytes=32 time<1ms TTL=128
Reply from 192.168.0.11: bytes=32 time<1ms TTL=128

Ping statistics for 192.168.0.11:
    Packets: Sent = 4, Received = 4, Lost = 0 (0% loss),
    Approximate round trip times in milli-seconds:
        Minimum = 0ms, Maximum = 0ms, Average = 0ms
```

4. Create a new project in Data Acquisition Studio software and monitor real time data from Recorder directly from PC

How to open Real Time Viewer

There are two ways to open Real Time Viewer



Click the desktop icon

Start-Programs-Data Acquisition Studio Studio-Real time viewer

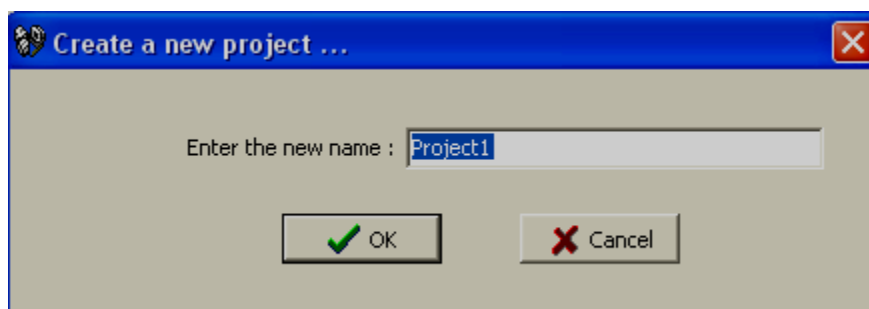

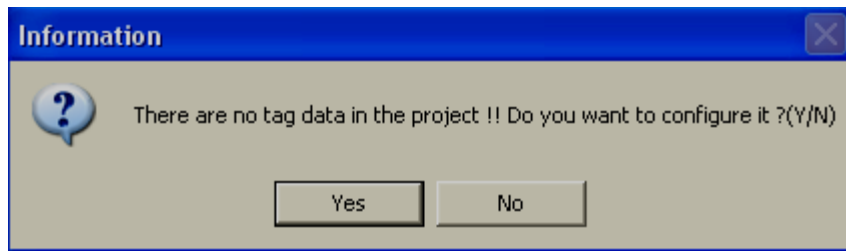

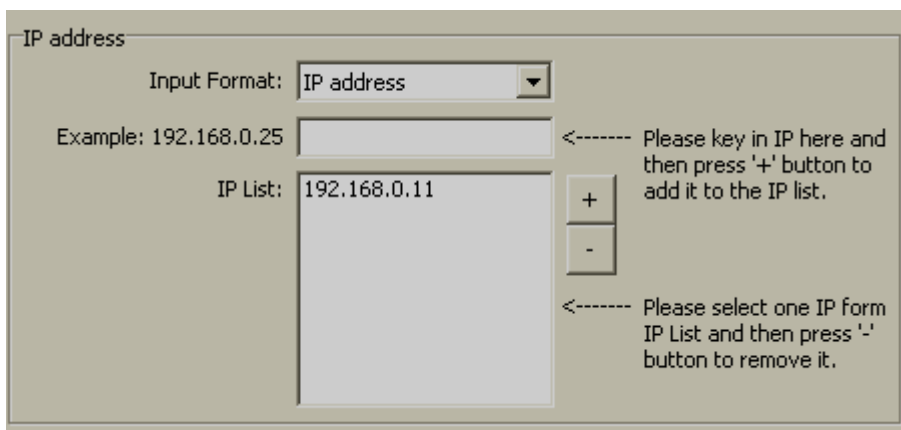
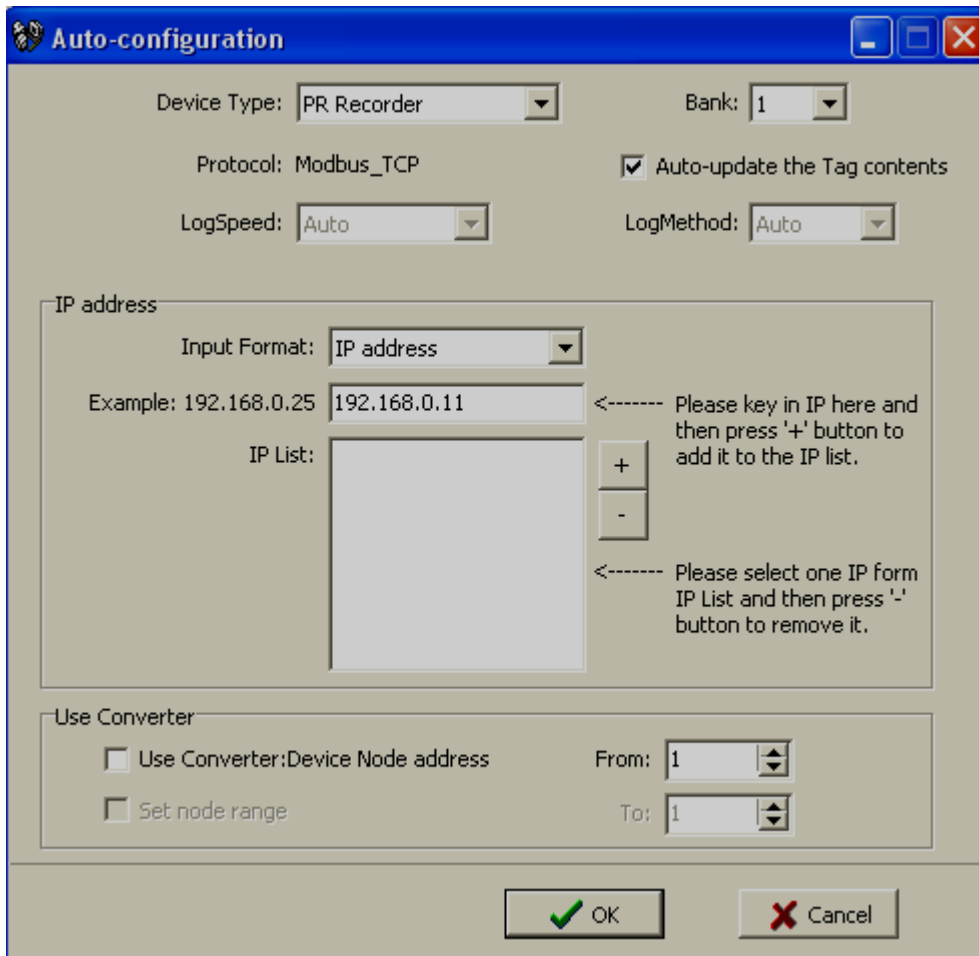

Click "Yes"

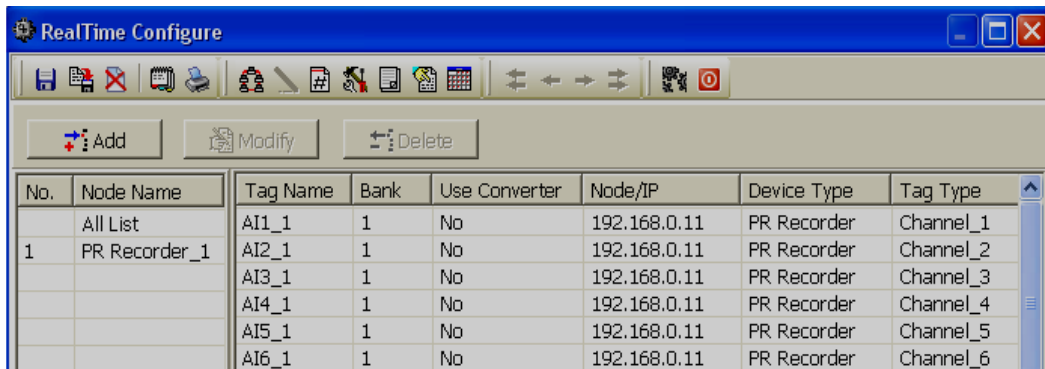

Click “OK”



Click “Save” icon . To close, click the return to main program icon .

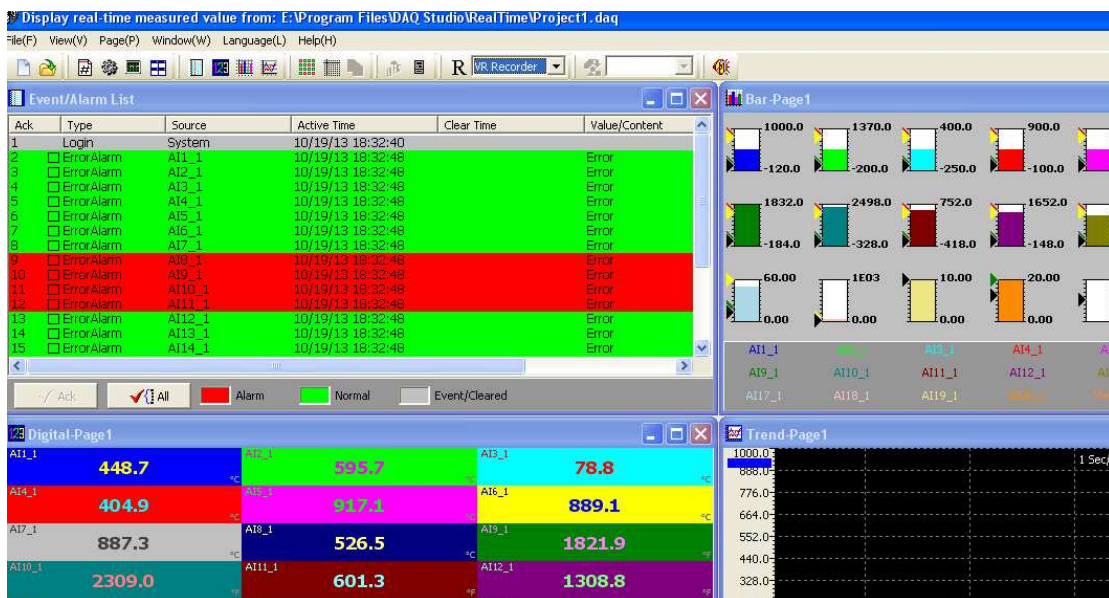

Note: When real time viewer is running in PC, data will be stored on the computer hard drive. This data can be archived later from Real time viewer itself using the “Measured data” icon. This data is same as the recorder’s internal memory (Historical data).

In the case of a PC running round the clock (like a server), there may be no need to manually transfer historical data from Recorder to PC via Memory stick.

Note: Please read “Real time viewer” help file from software itself for all the features available in Real time viewer software

5.2.13 Serial (RS232/422/485)

The procedure is similar to Ethernet. But the bank must be set for Modbus Serial.

5.2.14 View Real time data from Multiple Recorders

Assume one Recorder database has already been added in Ethernet using IP address 192.168.0.11

Target: Connect a second Recorder, IP address 192.168.0.12 to the Real time viewer

Connect both the Recorders and PC to Ethernet switch

Use “Ping” instruction at DOS prompt and check communication between PC and two Recorders. If there is no response, then check IP address in all the devices. Also check Ethernet cables.

If there is good response from Recorders using the “Ping” instruction, Open Real time viewer

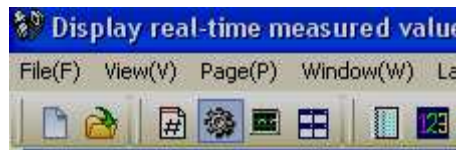

Click “Configuration data” icon 

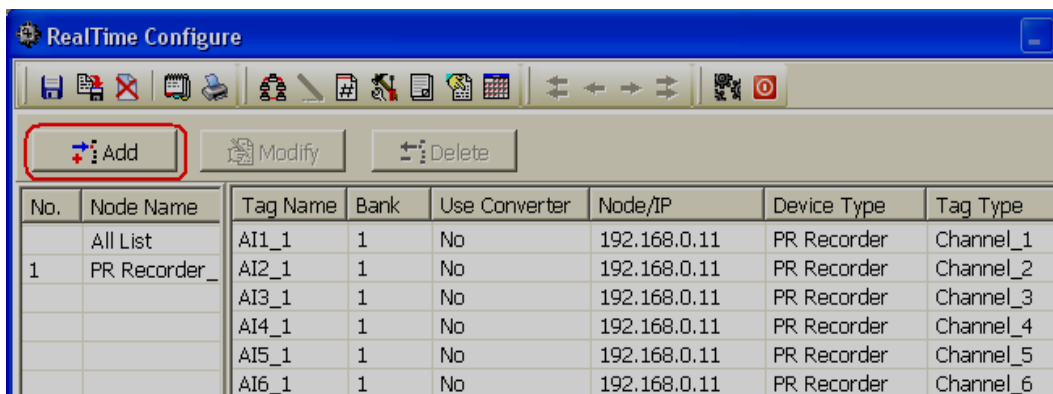

Click “Add”



Select Device Type = PR Recorder

Deselect checkbox next to “Auto-update the Tag contents”

Enter IP address of second Recorder. (Make sure to select user define IP address in Recorder. Do not select “automation”)

Click “OK”

Now, second Recorder database will add to Real time viewer.

5.3 Panel Studio version

Using this software you can develop custom screens for your display same as SCADA. All the graphics developed on the screens can also be configured for animations.

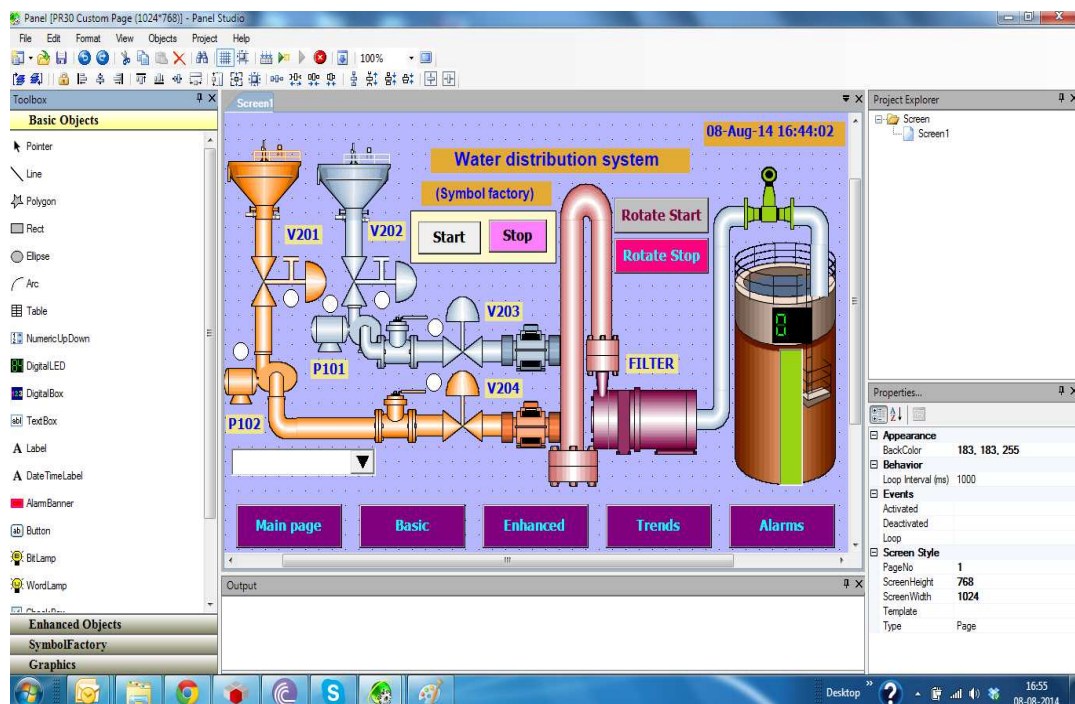

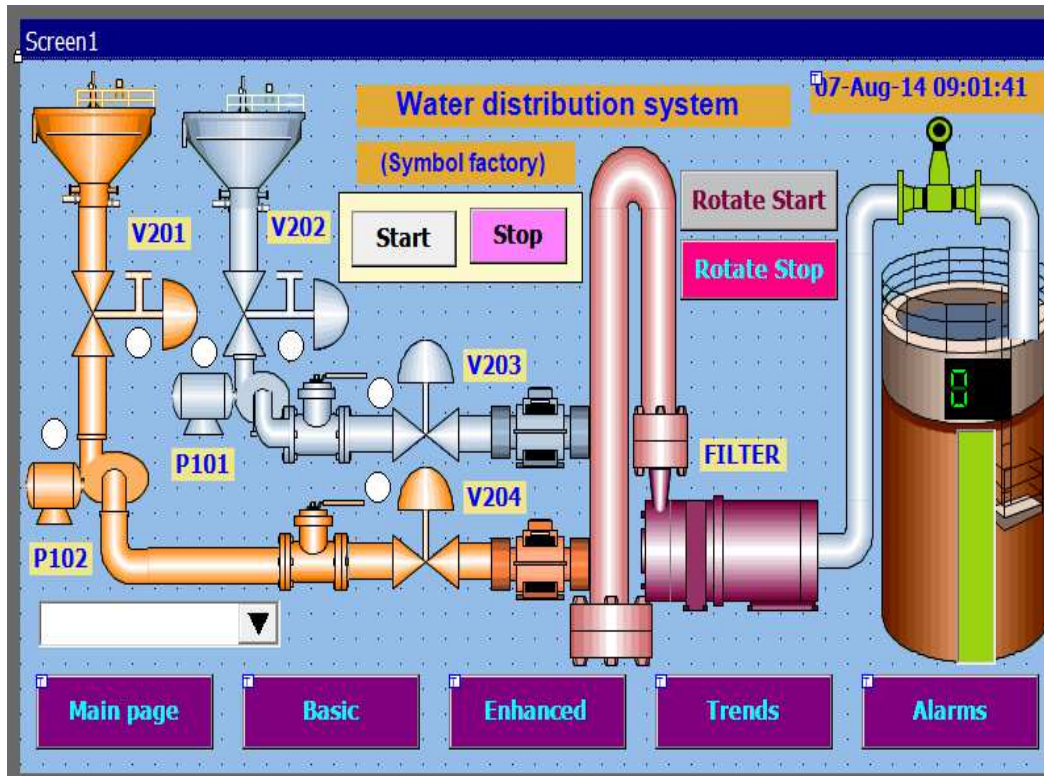

Use this editing software to develop animation screens on the Recorder. It is mainly used for application development useful for operator interface in industrial applications. Using Screens, operators will be able to communicate with PLC's, inverters etc. via COM ports, the Ethernet port, on Modbus RTU or Modbus TCP/IP. Using this software, it is possible to develop operator interface applications like the following.

- Sending start/stop command from Recorder to PLC to start motors, pumps etc.
- Display running stats of motors, pumps etc.
- Display Real time value of process parameters like temperature, flow, pressure etc
- Visualize process data in meaningful ways such as bar graphs, dial, meter, level, digital LED etc.
- Animation like visibility control, blinking, horizontal movement, vertical movement etc.

5.3.1 System Requirements

- Recommended hardware:
- PC with 2 GHz processor, 1GB RAM
- 50GB free space in the hard disk.
- Ethernet port, RJ 45 female
- Minimum 20% free space in hard disk, Less than 10% space generates error message

RS 232 serial port, RS485/RS232 converter to check online simulation if required

USB host to insert USB flash disk

Screen resolution better than 1024 X 768 (For Recorder 10" and 1550 projects)

Operating system: Windows XP, Windows Vista, Windows 7, Windows 2000 & Windows 2003 Server

5.3.2 Software Installation

Install Microsoft installer V3.1

Install Microsoft.Net frame work V3.5 SP1

Install Editing Software

Install OPC server

Install Demo projects

Install Historical viewer

Install Remote viewer



If any folders or files are deleted manually from C:\Program Files\Panel Studio, then delete a file by name "BCFile" manually from C:\WINDOWS before attempting to start new installation process. Otherwise, you may get error message "Access Violation".

5.3.3 Project status

During design time, it is possible to check current status of resources being used

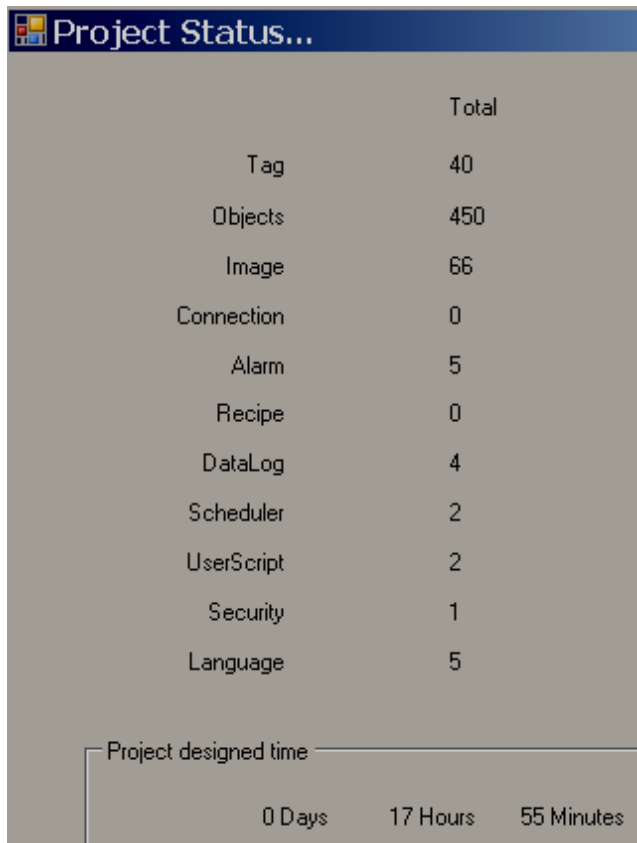
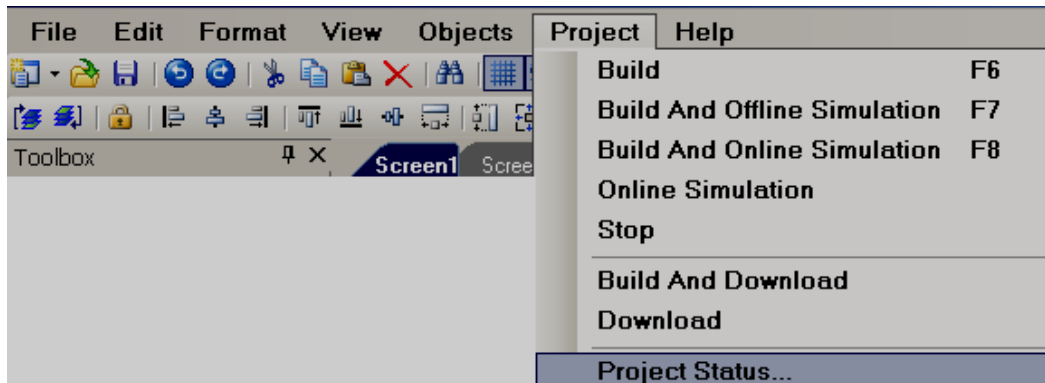

“Image” means symbols used from graphics and symbol factory. These symbols are also considered objects, so, if you add symbols, it also updates quantity in objects.

For example: If you add 2 symbols and one rectangle object. Then, Images = 2, Objects = 3

5.3.4 Create new project

Open Recorder Editing Software from desktop icon or from Start-Programs-Recorder Editing Software

Click on “Create a new project”

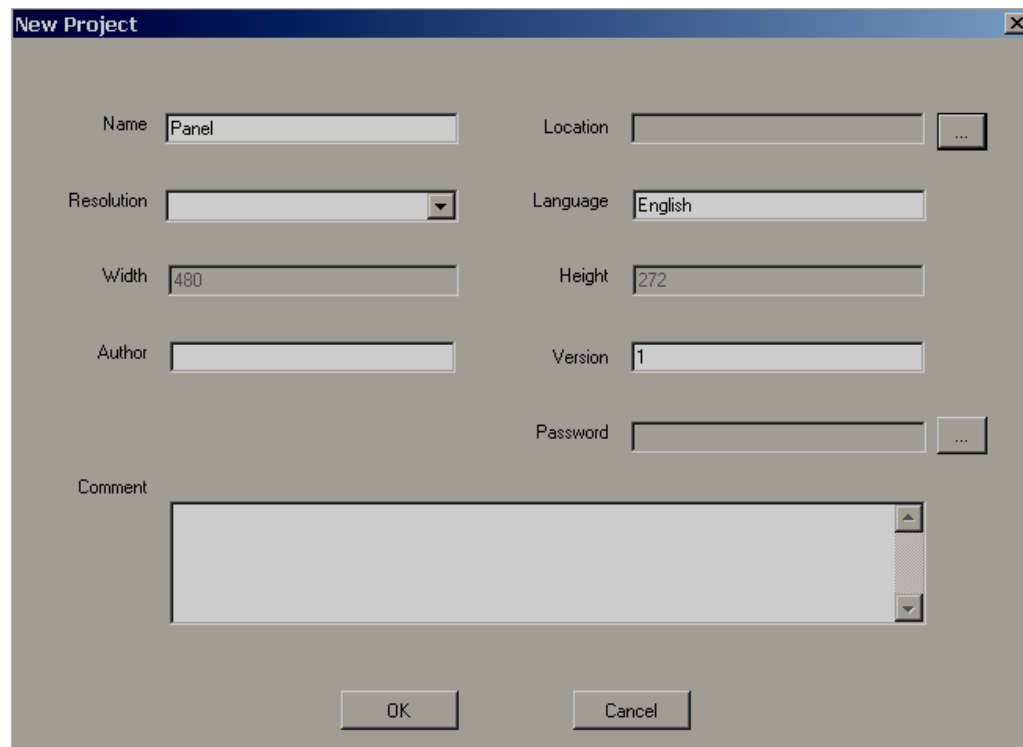
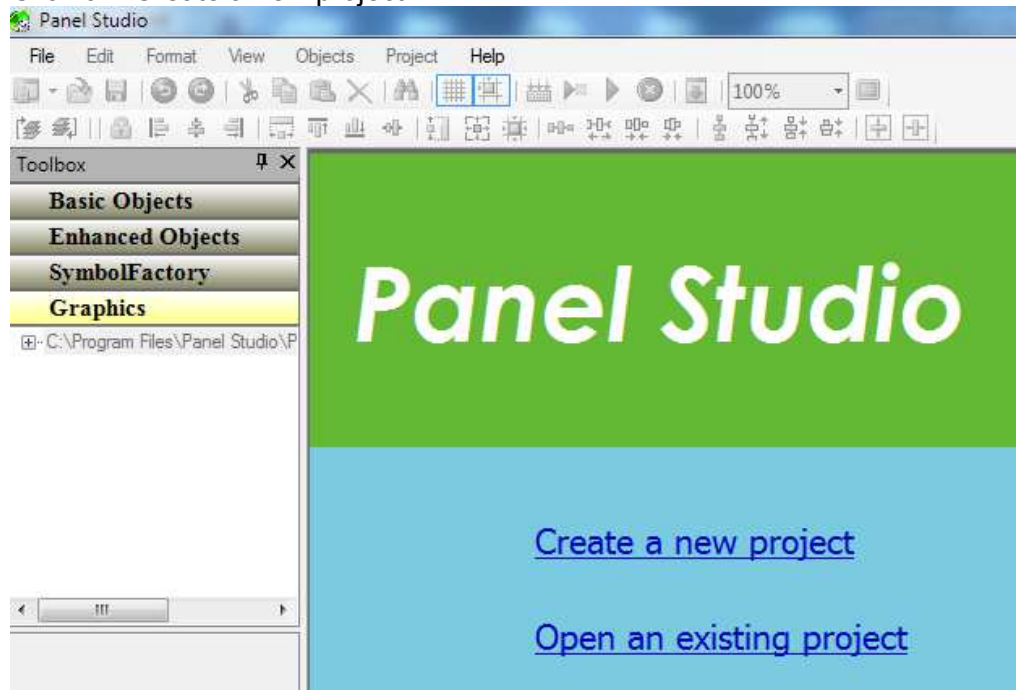

Project Name: It is Name of the Project. For ex: Boiler

Location: It is path for project file storage.

Default Language: English

Width: It is pixels, resolution in dots available on X-axis

Height: It is pixels, resolution in dots available on Y-axis

Author: Write author name/system integrator name for future reference

Version number: It is for version management

Comments: It is for project management

After entering all the above details, click “OK”

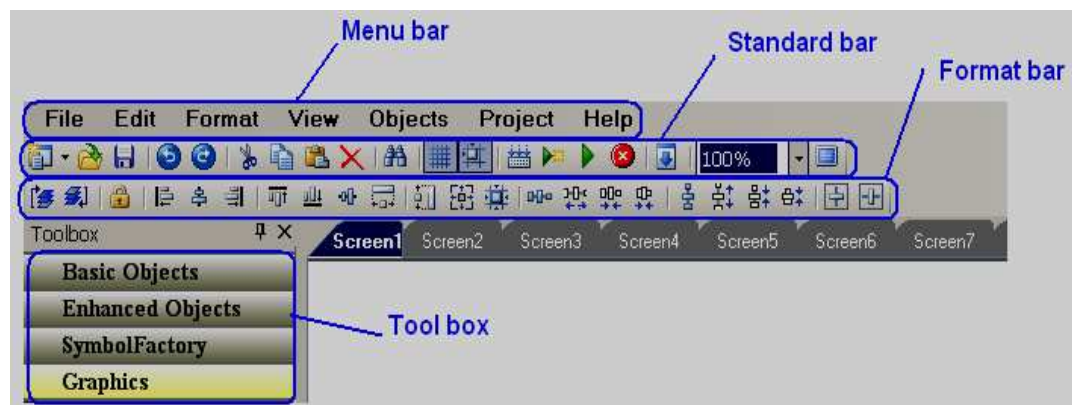
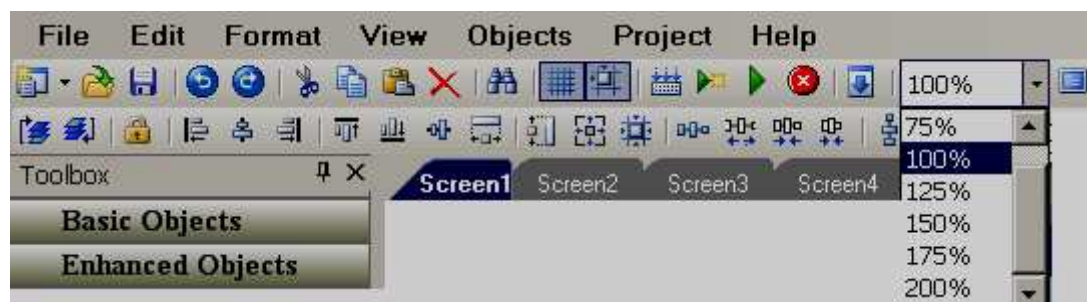

5.3.5 Menu bar

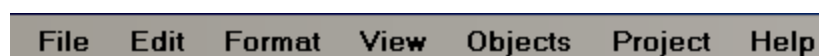

5.3.6 File

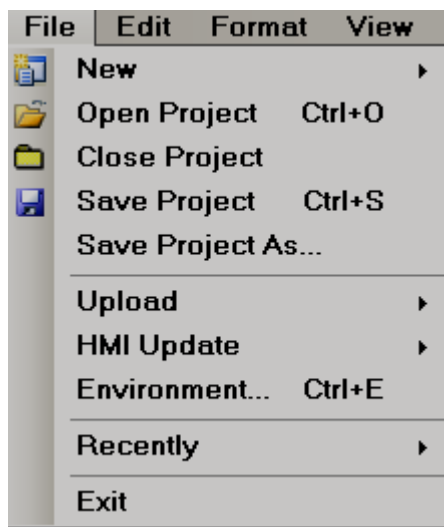

New: To create a new project

Open Project: To open existing project

Close Project: To close present project

Save Project: To save Project in default path

Save Project As: Saves project in selected path other than default path specified while creating a new project settings.

Upload: To upload project from Recorder back to PC

Recently: It is to open recently opened projects

Exit: To exit from current project

Language: To update language files in Recorder. This is required only if a new language required at Control Center. Contact factory for further information

Clock Synchronization: To synchronize recorder clock with PC clock.

5.3.7 Environment

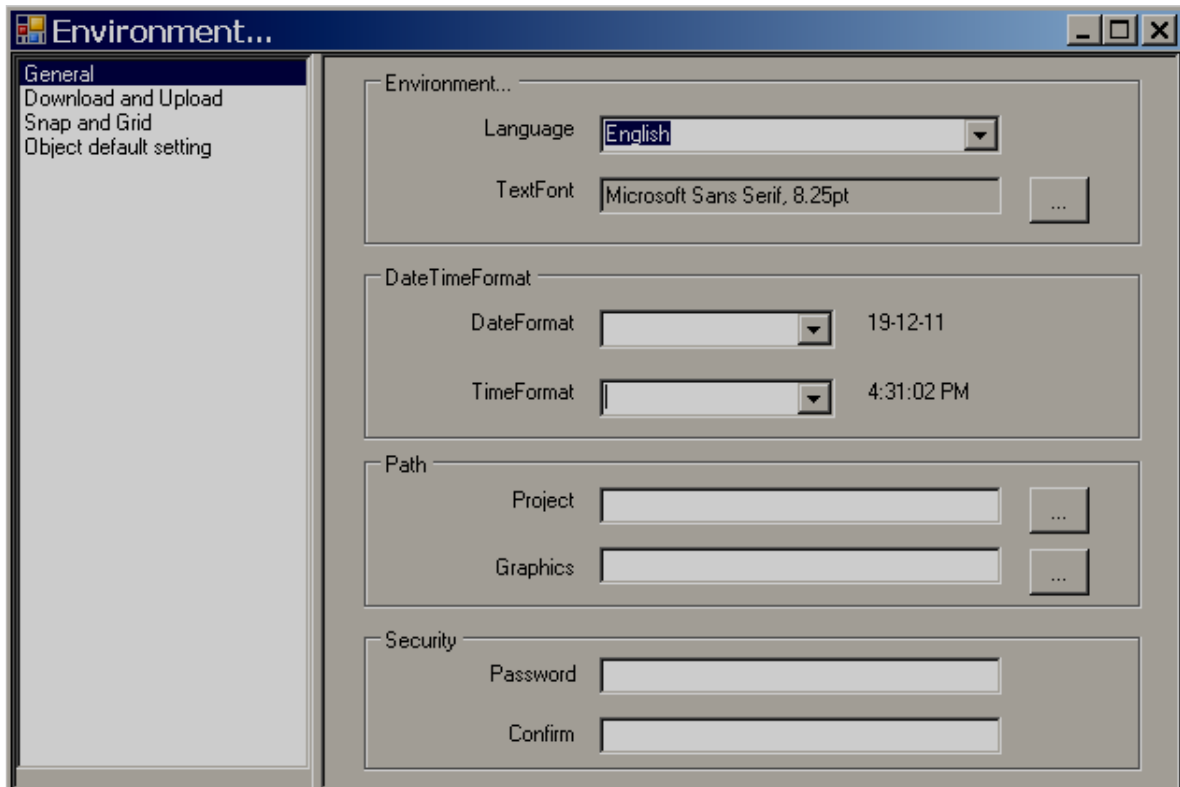

General:

Language: Select Language for project environment. 20 languages are supported from Recorder editing software V1.1 onwards including English, Simplified Chinese, Traditional Chinese, Japanese, French, German, Italian, Polish, Spanish, Portuguese, Brazil Portuguese, Russian, Thai, Czech, Danish, Dutch, Korean, Swedish, Turkish & Greek.

Environment font: Select font required for design time environment.
Example: Menu, Tool Box, Project explorer, function editor etc.

Project Path: Location to storage of project files
Default project path: C:\Program Files\Recorder Editing Software\Recorder Editing Software\PanelProject

Graphic Path: Location of default basic Symbols
Default graphic path: C:\Program Files\Recorder Editing Software\Recorder Editing Software\Basic Symbols

Security: This is to protect opening Recorder editing software in specific Personal computer (Not for project). Once password is entered, it is required to enter password correctly to open Recorder editing software for the current session. This is useful in factory environment to prevent un- authorized users to open Recorder editing software.

Note: If you need a password for a specific project, click “Settings” in the project explorer, select “General” tab, then enter the Password.



In general, it is preferred to back up project files regularly in other standard storage media like CD, DVD etc. It is recommended to store project files in separate folders on the D: drive instead of C: drive. Developers may make a hard disk partition and save all project files in drives other than location of operating system in the event that if there are problems with Operating system, it is still possible to retrieve project files.

Download and Upload: Please refer to section “Project tools” for more detailed information.

Snap and Grid: Used to define grid behavior in the design time environment.

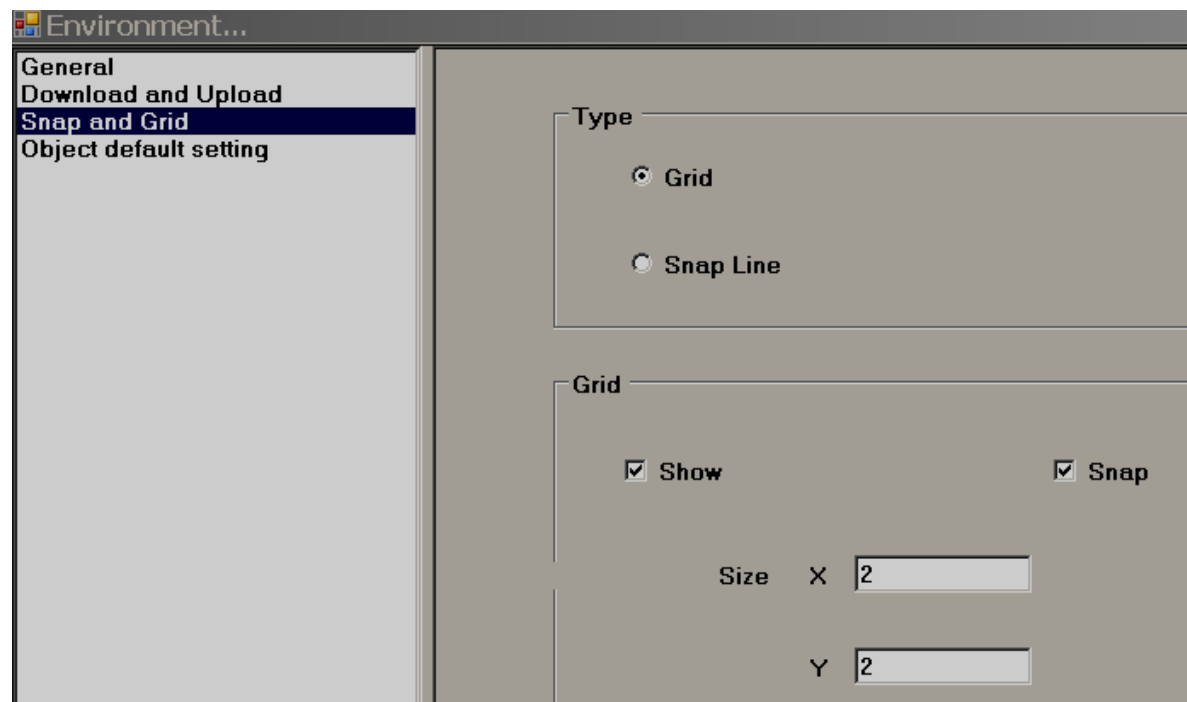

Grid: Select this option and select “Show grid” if grids are to be appeared in screen at design time.

Snap lines: Select this option if grids are not required to appear in screen at design time.

Snap: Select this option if component coordinates should within grids all the time.

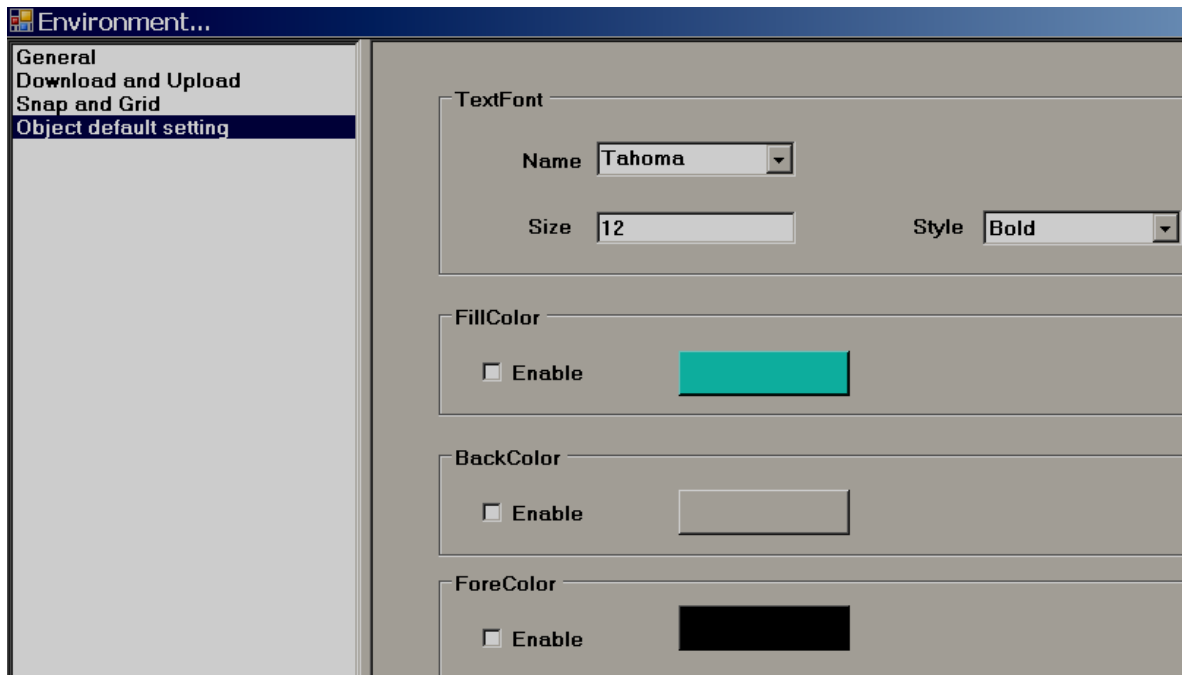

Object: Define default font size, Fill color, Back color and Fore color for the properties of most of the objects (label, Check box, Rectangle, Ellipse, Pie, Table, Dial, Level, Meter, Slider, Thermometer etc.).

5.3.8 Edit

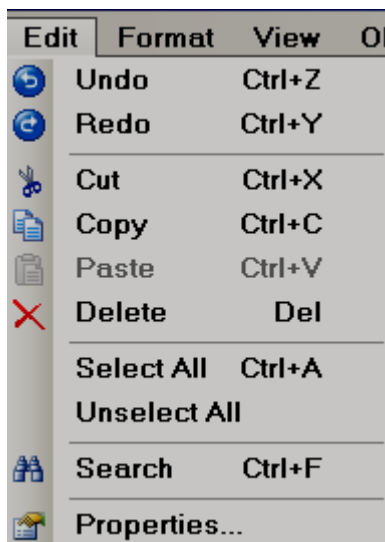

5.3.9 Format

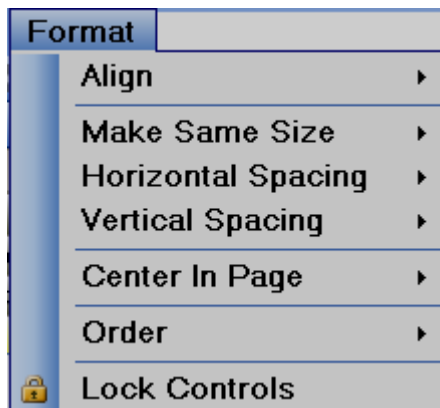

Align: Used to align selected components, objects etc. for adjusting their position precisely in the screen layout. Available options for selection are Center, Right, Left, Top, middle & Bottom.

Example: Align two Labels to the left in Recorder screen.

Assume both labels are created in Screen1. Select both labels first using your mouse. Alternatively, select first label by left clicking the mouse, then press "Ctrl" on the keyboard and select the second label by left clicking the mouse. Now, in Menu, click "**Format**", then select "**Align**", then select "**Left**".

Before Align adjustment

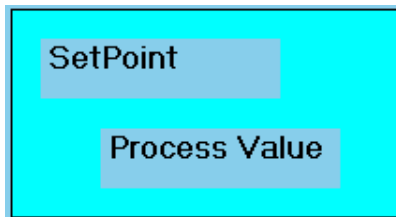

After Left Align adjustment

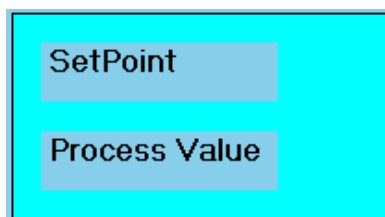

Make Same Size: To adjust different objects to the same Width, Height, Both width and height, Size to grid etc.

Example: Adjust five buttons to same size i.e., height and width.

Create five buttons first. Then, select all these buttons via Mouse, then click "**Format**", then select "**Make same size**", then select "**Both**".

Before size adjustment



After Same Size adjustment



Horizontal spacing: It allows adjustment of horizontal spacing between any objects to make Equal/Increase/Decrease/Remove.

For example: There are 3 buttons located at bottom area of a page. Spaces between these buttons are not equal and screen does not look good. Select all the 3 buttons via Mouse or using “Ctrl” on the keyboard along with mouse. Then in Menu bar, click “Format”, then select “Horizontal spacing”, then select “Make equal”. Now, space between all these buttons will have an equal distance.

Before Spacing adjustment



After Horizontal spacing adjustment



Vertical spacing: It allows adjustment of vertical spacing between any objects to make Equal/Increase/Decrease/Remove

Before Spacing adjustment

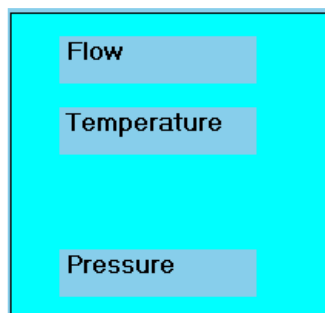

After vertical spacing adjustment

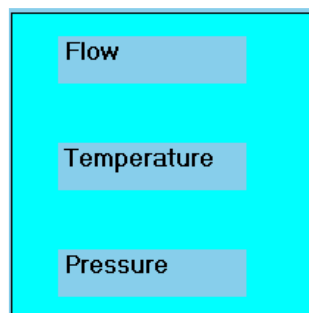

Center in Page: It allows adjusting objects to the center of the page horizontally and vertically.

For ex: There are 3 buttons located at screen. You wish to locate them in the center of the page horizontally. Select these buttons and apply this feature to adjust buttons as per requirement.

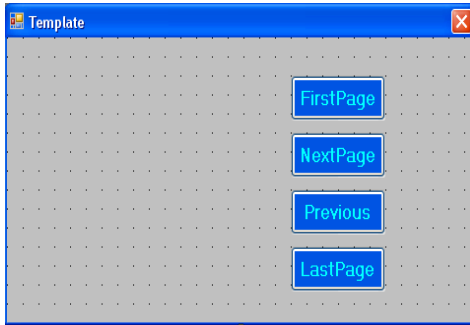

Order:

Bring to back: Moves objects to the back

Bring to Front: Moves objects to the front

For example: There is Rectangle box and a label with different colors. If you wish to keep label text in front of the Rectangle, select the Rectangle, choose the option, “Bring to Back” and for the label, choose the option “Bring to Front”, such that both are visible at same time allowing overlapping of two objects for clear display.

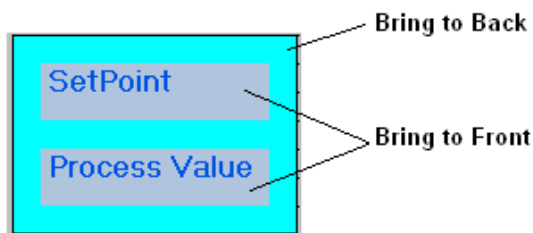

Lock Controls: It is to lock control for further development. Apply this for a second time to unlock the control.

5.3.10 View

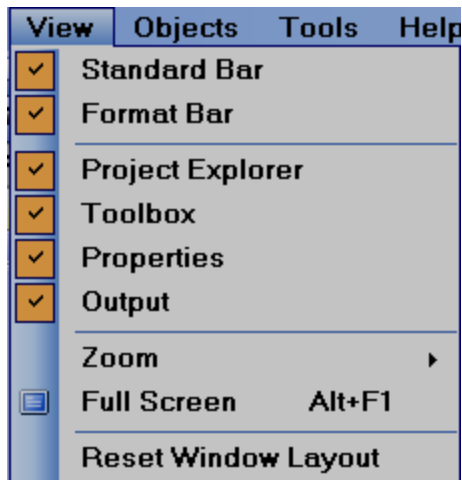

Select the required items to view in window layout.

Properties

If “properties” is checked as shown above, in the right side bottom of screen layout, the properties box will appear showing all the properties for the component/object that is selected.

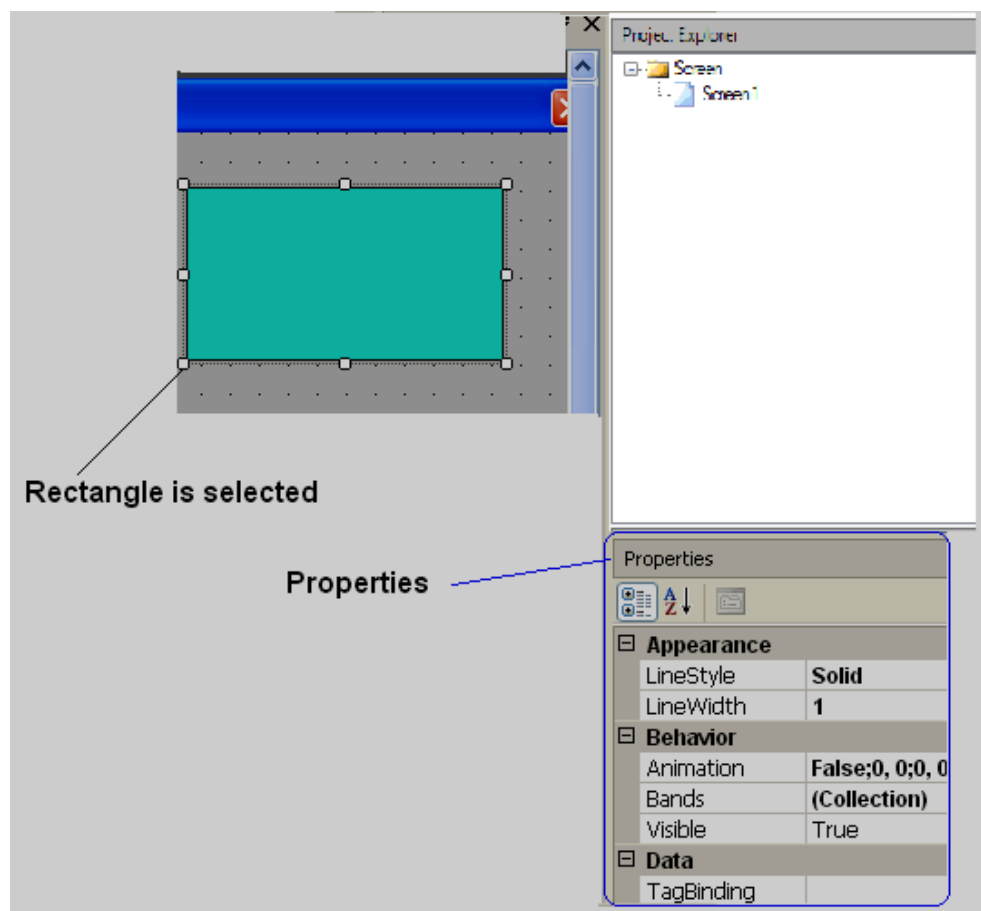

In above example, a rectangle is drawn, and once it is selected, the right side bottom corner will show all the properties for this specific rectangle if “properties” is checked

in the View dropdown menu. It is possible to modify properties of the rectangle from property grid. Alternatively, if you double click on the rectangle, you will see a pop-up window where you can edit properties.

Output

If output is selected in the view drop-down menu, this window appears just below the screen working area. This window will display any errors that appear during compilation of project.

In Menu, click “Tools”, then “Build”, or alternatively, on the “standard” bar, click the icon  to prepare the build for the application. The project will then compile. A summary is shown in the output window as shown below.

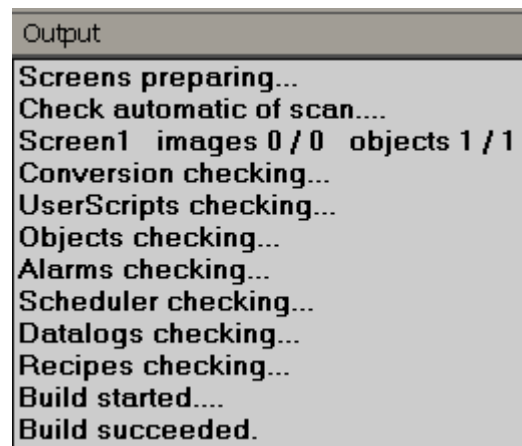

```
Output
Screens preparing...
Check automatic of scan....
Screen1 images 0 / 0 objects 1 / 1
Conversion checking...
UserScripts checking...
Objects checking...
Alarms checking...
Scheduler checking...
Datalogs checking...
Recipes checking...
Build started....
Build succeeded.
```

Zoom

It is used to Zoom the current screen to various %, and it is useful during screen editing, particularly if screen size of PC screen is small. If 200% is used and if PC screen size is small, then horizontal and vertical slider will appear automatically in screen to navigate to other areas of screen easily.

Full screen

It is to display full screen. After selection, the screen layout will be as shown below. To go back, in menu, click at “View” and then “Full screen” again

Reset window layout

Used to display the default screen layout showing the screen working area, tool box, project explorer, output window etc.



Ex: If user deselects the “project explorer” in the View drop-down menu, then it will not show the Project explorer at the right side of the window layout. In this case, the user may select Project explorer again in the View drop-down menu. Alternatively, in Menu, click “View”, then “Reset Window Layout”, then it will reset all the view selections and show default window layout.

5.3.11 Objects

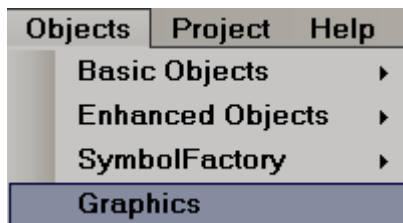

More details about Basic objects, Enhanced objects, Symbol factory and Graphics are explained in section “Tool Box”

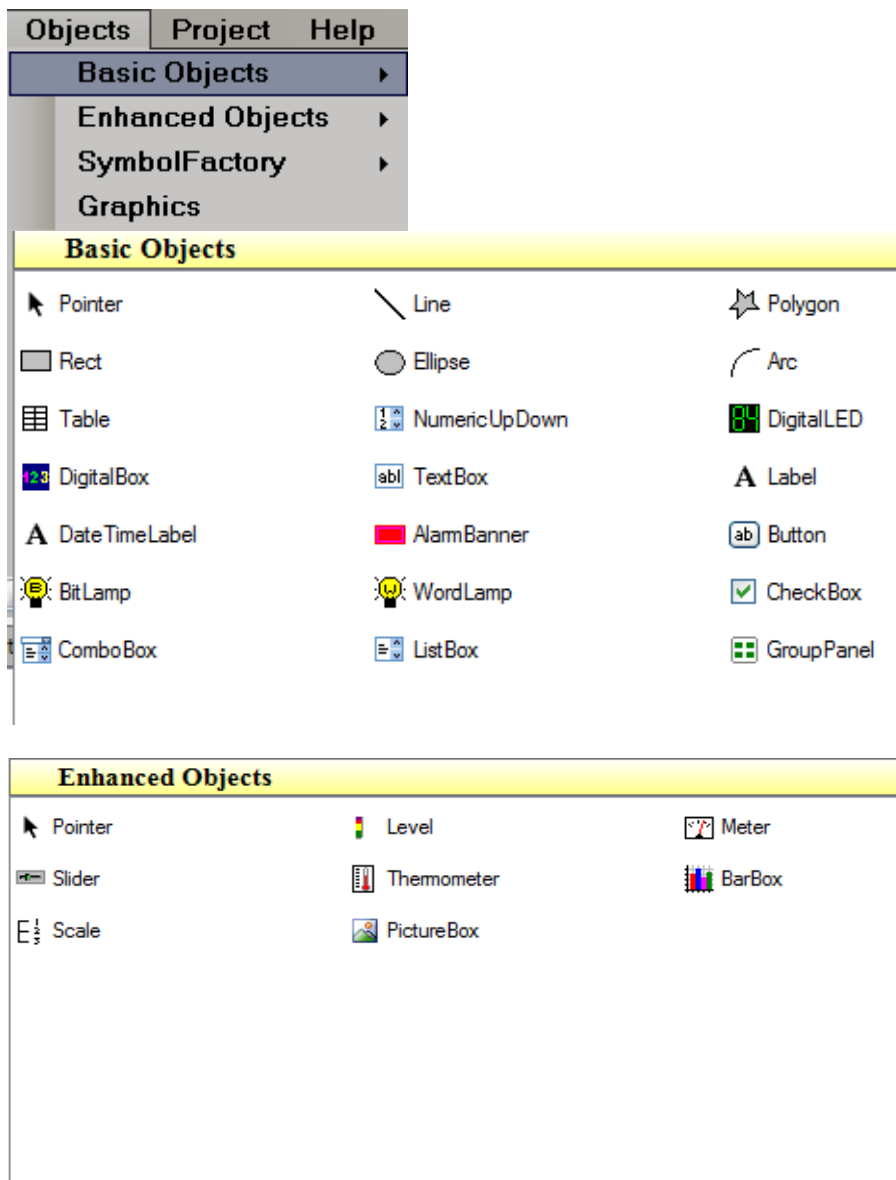

If you would like to increase font size in Menu bar, then, in menu, click File, then click “Environment” and then set font settings.

5.3.12 Project

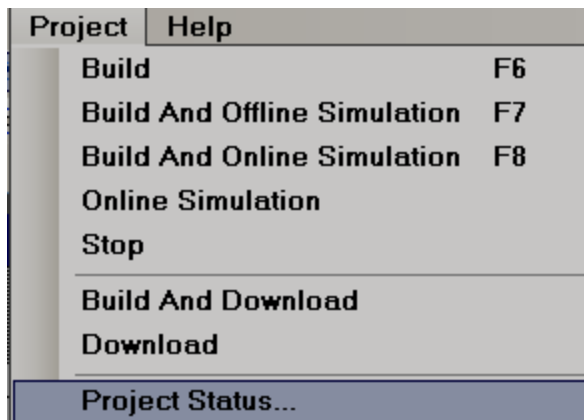

Above details are explained at section "Project Tools"

5.3.13 Standard bar



New Project



Open Project



Save Project



Undo



Redo













Cut



Copy



























Paste

-  Delete
-  Search
-  Show Grid
-  Align to Grid
-  Build
-  Offline Simulator
-  Online Simulator
-  Stop simulation
-  Download
-  Full screen

5.3.14 Format bar



- | | | |
|--|---|--|
|  Bring to Front |  Bring to Back |  Lock the control |
|  Group |  Ungroup |  Align left |
|  Align center |  Align right |  Align Top |

- | | | | | | |
|---|-------------------------------|---|-----------------------------|---|-----------------|
|  | Align bottom |  | Align middle |  | Make same width |
|  | Make same height |  | Make same size |  | Size to grid |
|  | Make horizontal spacing equal |  | Increase horizontal spacing | | |
|  | Decrease horizontal spacing |  | Remove horizontal spacing | | |
|  | Make vertical spacing equal |  | Increase vertical spacing | | |
|  | Decrease vertical spacing |  | Remove vertical spacing | | |
|  | Center vertically |  | Center Horizontally | | |

5.3.15 Project Explorer

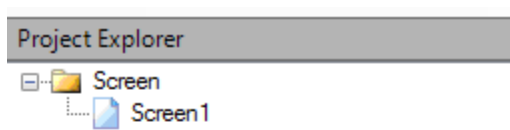

5.3.16 Screen

This is to add new screen to the project.

It is possible to set screen into the following types

1. Page

When a new project is created, screen1 (Page type) is created by default. It is not possible to change screen1 to either template or popup. Screen1 (start page) should be "Page" type only.

How to add a new page

In Project Explorer, select "Screen1", then right click your mouse. It will show the screen below. Click "Add", and Screen2 will be created and will appear as shown below.

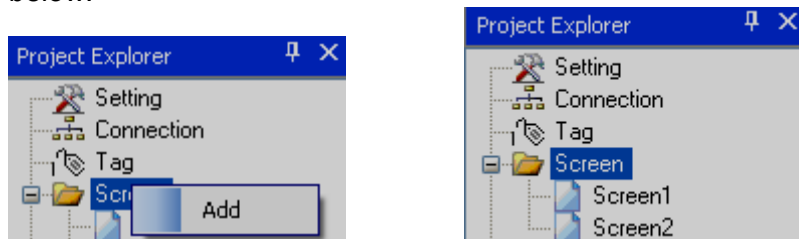

Now, Select Screen1, then check its properties. For example: It is possible to change the background color of a screen from the page properties

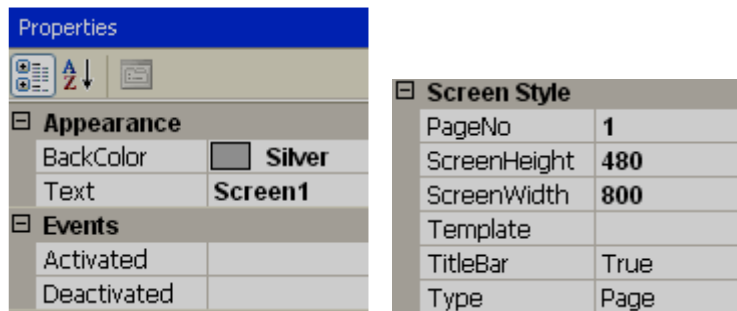

Right click your mouse keeping the pointer on any page, then, you can edit screen properties via the wizard.

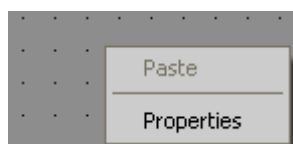

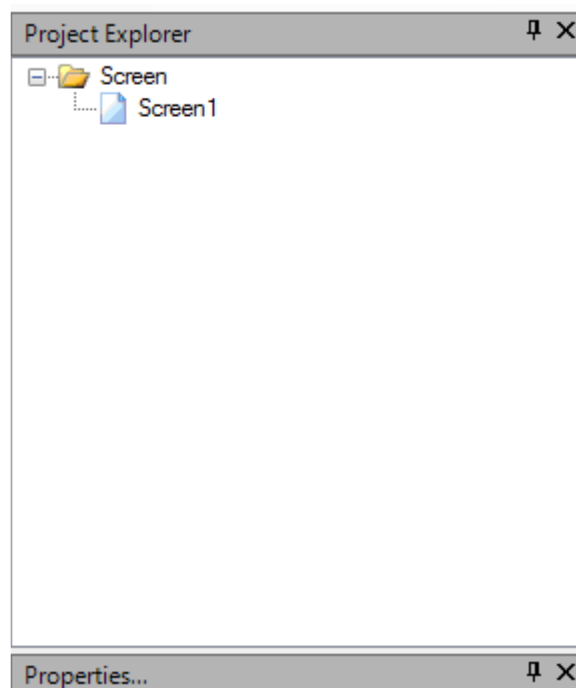
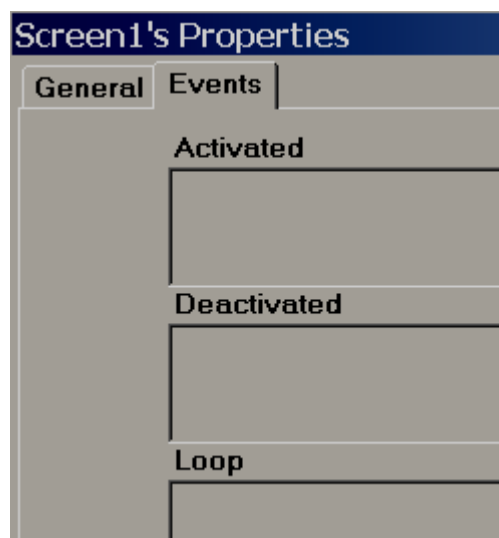
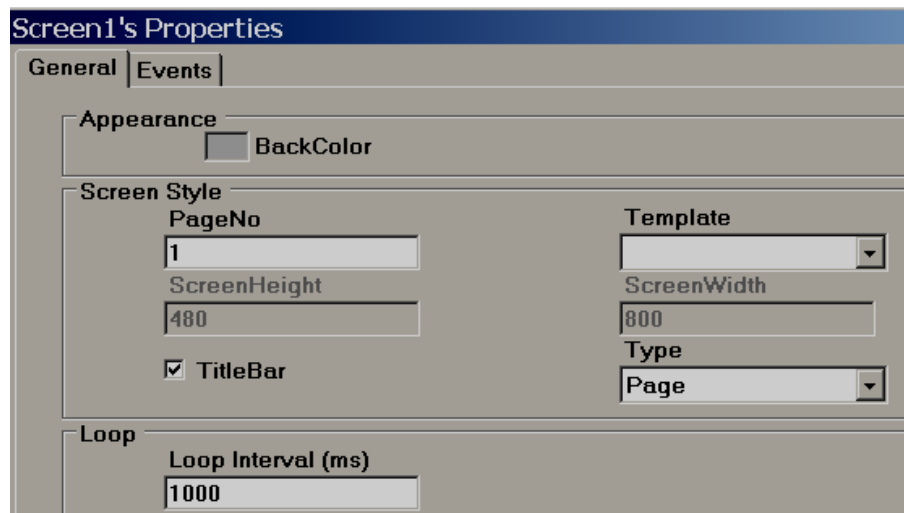

It is possible either to open, delete or rename a screen. Select the appropriate screen in the project explorer, then “Right click” the mouse to show the above Screen dialog.



Note: These screen display names are the same as those available at project explorer. These are different from title bar (Text) defined for screen.

Properties:

Back Color: Defines the background color of a component.

Events:

Activated: Defines tasks to be executed before opening a Screen.

Deactivated: Defines tasks to be executed before closing a Screen.

Screen Style

Page No: Displays current page number.

Screen Height: Defines/Displays current screen height.

Screen Width: Define/Display current screen width.

Template: Select the Template page for this screen.

Title bar: Control visibility of Title bar and select it in design time.



If “Title Bar” is selected in Page properties, then, the number of grids vertically in screen multiplied by grid size will not match the screen height since the Title Bar occupies some space.

Type: Defines the type of screen. Available options include Template, Page and Popup.

5.3.17 Tool box

These can be accessed from menu bar also from objects.

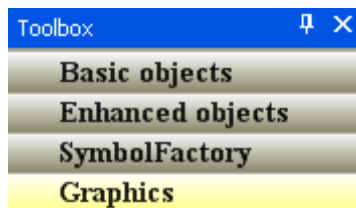

5.3.17.1 Basic Objects

It is to draw simple shapes in the screen, data entry, data display, alarms view etc.

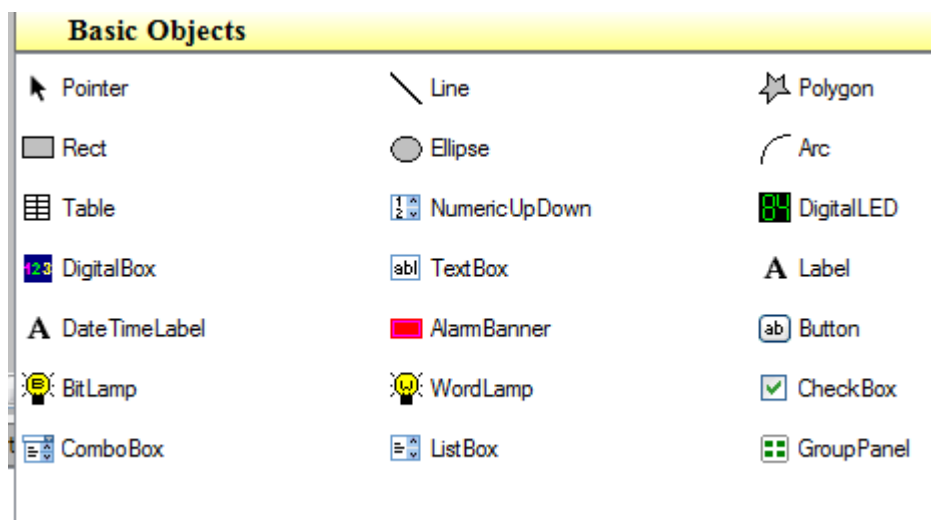

There are three ways to insert the above objects into the screen.

- i) Drag and drop.
- ii) Select the object, say a line, then use the mouse to draw a line on screen.
- iii) Select the object, then double click (mouse left click) quickly by keeping pointer on selected object. Then, the object will appear on screen. For example, select "line" and Double click it 3 times by keep mouse pointer on line, you can see 3 lines appear on the screen.

After inserting object to screen, it is possible to edit its properties either by Graphical User Interface (GUI) dialog or editing properties directly in property grid.

How to edit via GUI dialog

Insert any object in a screen. Select the object, right click the mouse, and then select properties.

Or

Insert any object in a screen. Double click on the Object. A GUI dialog will open automatically.

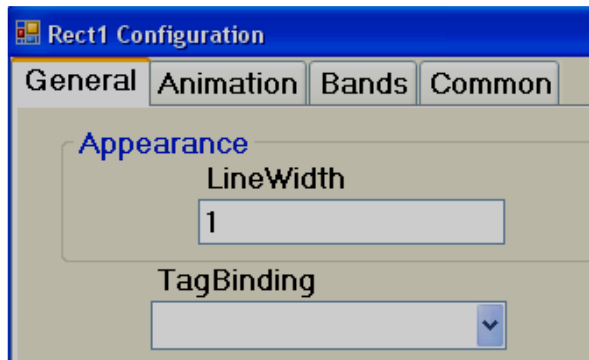

How to edit via Property grid

By default, the property grid will appear at the bottom-right area of the screen editor. If it is not available, click on the "View" drop-down menu, then click "Reset Window Layout". The property grid will appear at bottom right side of the screen editor just below the Project Explorer.

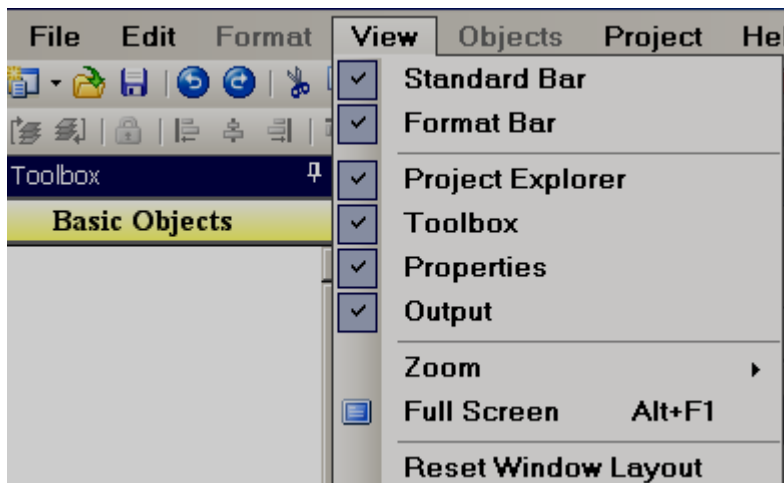

Property grid

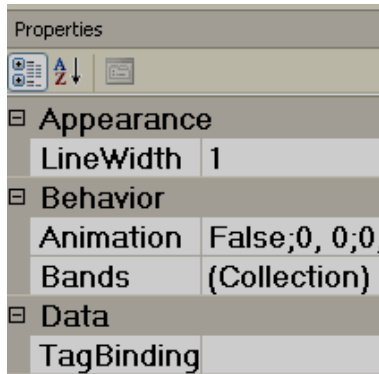

Before placing any objects in screens, check the section File- Environment and set default font size, fill color, fore color and back color for the objects as shown below.

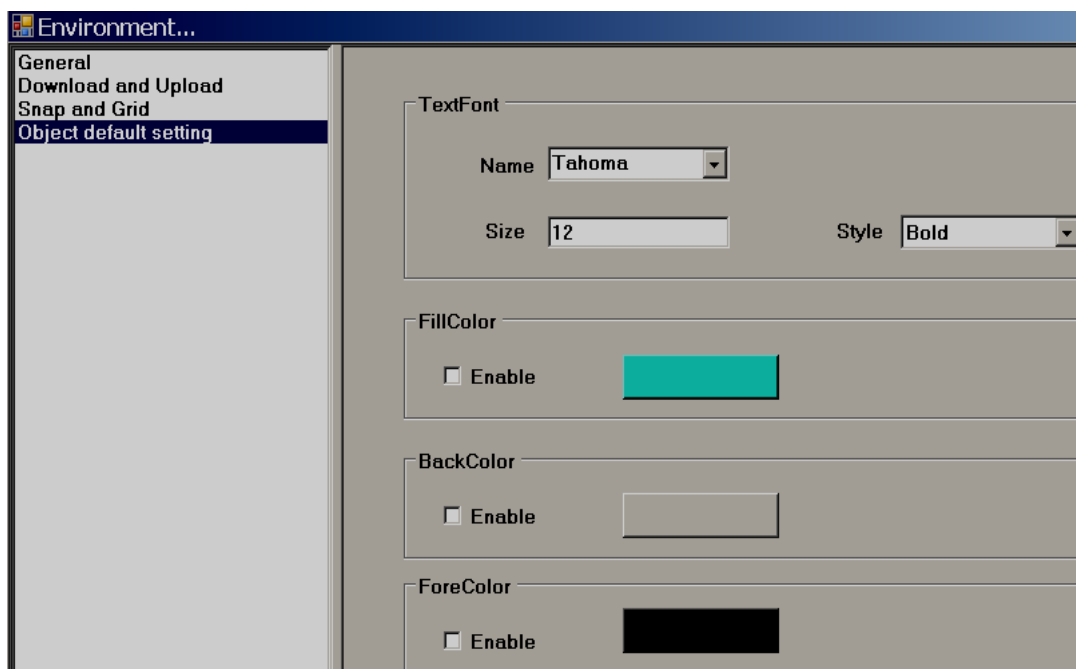

5.3.17.2 Common Properties

Appearance

Back Color: Sets the background color of the component.

Fore Color: Sets the Fore color of the component.

Bevel: Used to set the border including inner border, outer border and style of border.

Inner Border: True/False

Outer Border: True/False

Style: 9 styles are available

None, Flat, Single, Double, Raised, Lowered, Double Raised, Double Lowered, Frame Raised, and Frame Lowered

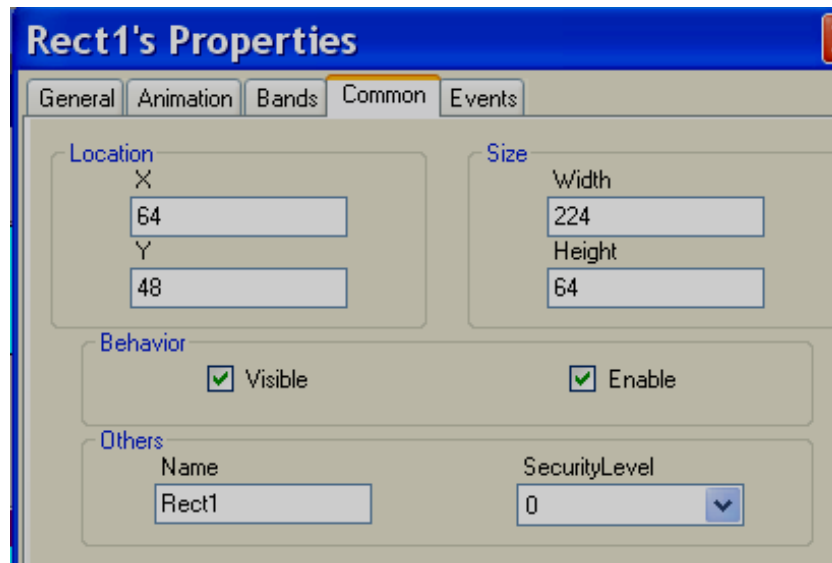

Behavior

Visible: True/False, determines whether component/control is visible or hidden

Enable: This is for event control. If linked with a Digital tag, when the tag value = 1 in run time, events configured for the object will be executed. If the tag value = 0, events will be not executed

Data

Tag Binding: Select the Tag of the desired process value

Write design time value: If selected, it writes the value available at "Text" in design time and in run time replacing the default value defined at Tag data base.

Design

Name: It is the name of the component.

Security level: Define the security level for the component.

Locked: True/False: It is to Move or Resize the component.

Layout

Dock: Defines which borders of the control are bound to the container.

Location: The coordinates of the upper-left corner of the component relative to upper-left corner of the container. Set X and Y position in screen in pixels.

Size: Size of the component in pixels. Set height and width of component in pixels.

☞ **Pointer.** It is to deselect the tool selection.

5.3.17.3 Line

☞ **Line:** An object used to draw a line and do animation in Run time when linked with a Tag.

User can edit properties via GUI dialog or property grid. After drag/drop of object to a screen, double click the object to open the GUI dialog, or, select the object and directly enter properties via the property grid available at bottom right corner of screen editor.

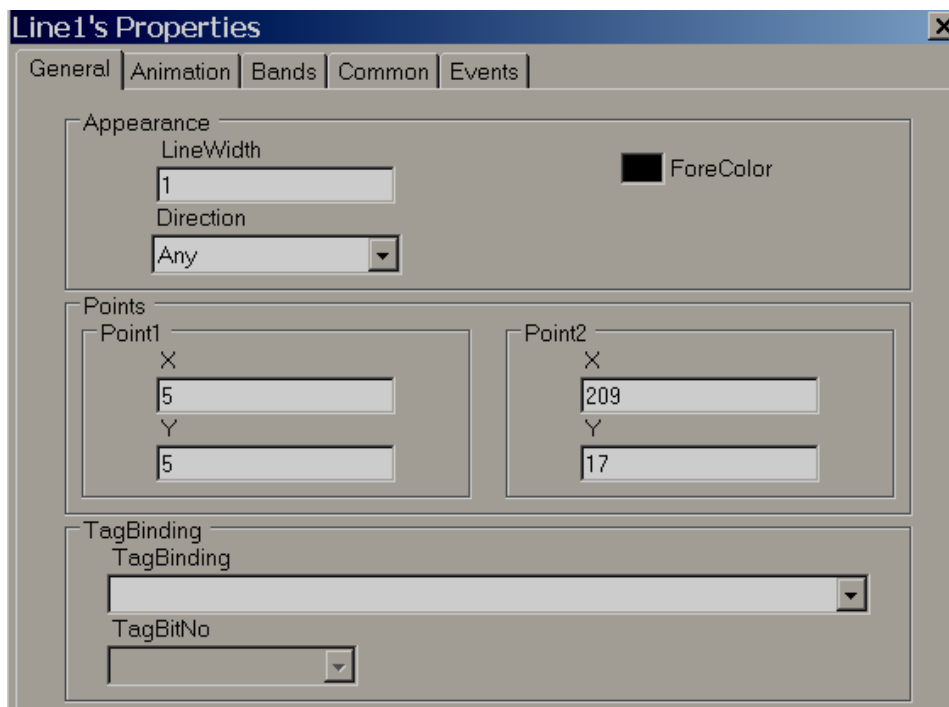

General

Appearance

Line Width: Define Line width

Direction: Horizontal or Vertical

Points

Point1: Define X and Y coordinate for line starting point and they show current position.

Point1: Defines the X and Y coordinates for the line end point and shows the current position.

Tag Binding

Select a Tag to be linked with this line. This is useful if animation is required.

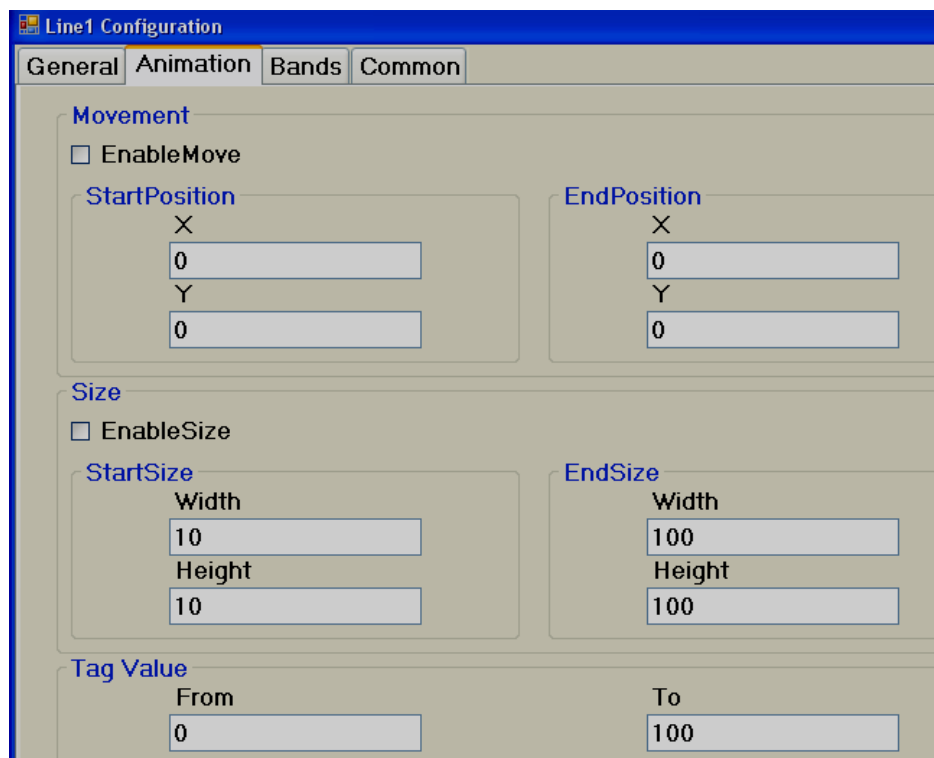

The screenshot shows the 'Line1 Configuration' dialog box with the 'Animation' tab selected. The dialog is divided into three main sections: 'Movement', 'Size', and 'Tag Value'. Each section has an 'Enable' checkbox and two input fields for 'Start' and 'End' values.

Section	Property	Start Value	End Value
Movement	EnableMove	<input type="checkbox"/>	<input type="checkbox"/>
	Coordinates (X, Y)	0, 0	0, 0
Size	EnableSize	<input type="checkbox"/>	<input type="checkbox"/>
	Dimensions (Width, Height)	10, 10	100, 100
Tag Value	From	0	100

Animation

This is to do animation on line in Run Time

Movement

Select "Enable Move" check box if movement animation is required during Run time.

Start Position: Defines X and Y coordinates for the start position when tag value is at its minimum during Run Time.

End Position: Define X and Y coordinate for end position when tag value is at its max. during run time.

The X position indicates movement from Left to Right, this is Horizontal movement. The Y position indicates movement from Top to Bottom, this is Vertical movement.

For example: Recorder 7" (High Performance) project,
800 X 480 pixels,
Normal installation, Horizontal (Left to Right) = 800 pixels,
Vertical (Top to Bottom) = 480 pixels

Enable move: Selected
Start position X = 0, Y = 0
End position X = 800, Y = 0
Tag Value, From = 0, Tag Value To = 100

Now, in Run time, when the Tag value = 0, the line will be at the Top left.
When the Tag value = 100, the position of the line will be at the Top Right

Size

Select "Enable Size" check box to enlarge/decrease size of component during Run time.

Start Size: Defines X and Y coordinates for the starting size when the tag value is at its minimum during Run time.

End size: Define X and Y coordinate for end size when tag value is max. Run time.

Tag Value

Select a Tag to be linked with this line. This is useful if animation is required to be done on the line.

Bands

This is to select various bands as part of an animation during Run Time

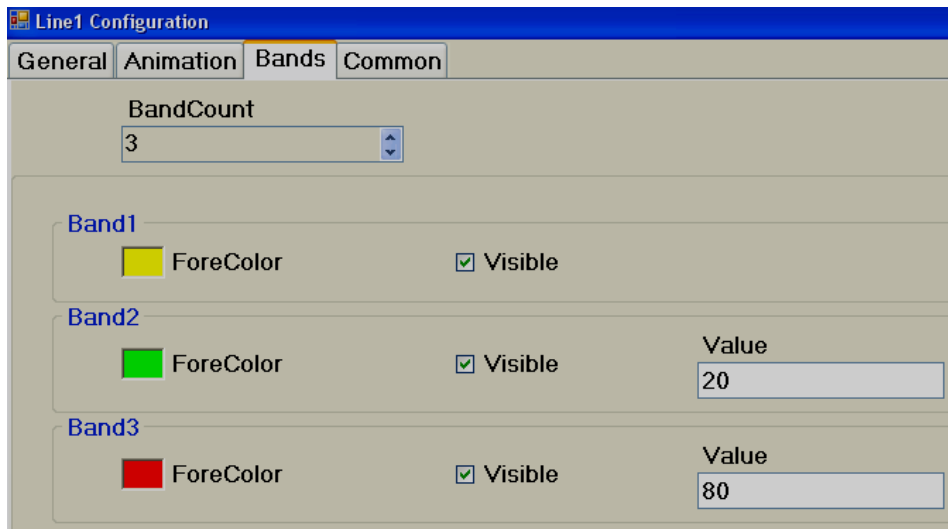

Band Count

A maximum of 32 bands are available.

For example: In the above sample,
 If the Tag value is 0 to 20, the line will be Yellow
 If the Tag value is 21 to 80, then, line color = Green
 If the Tag value is above 80, line color = Red

5.3.17.4 Polygon

✦ **Polygon:** Used to draw a polygon. After finishing drawing, double left-click the polygon using the mouse to complete the Polygon. It is also possible to link a polygon to a tag and define some user friendly animation to appear during Run time.

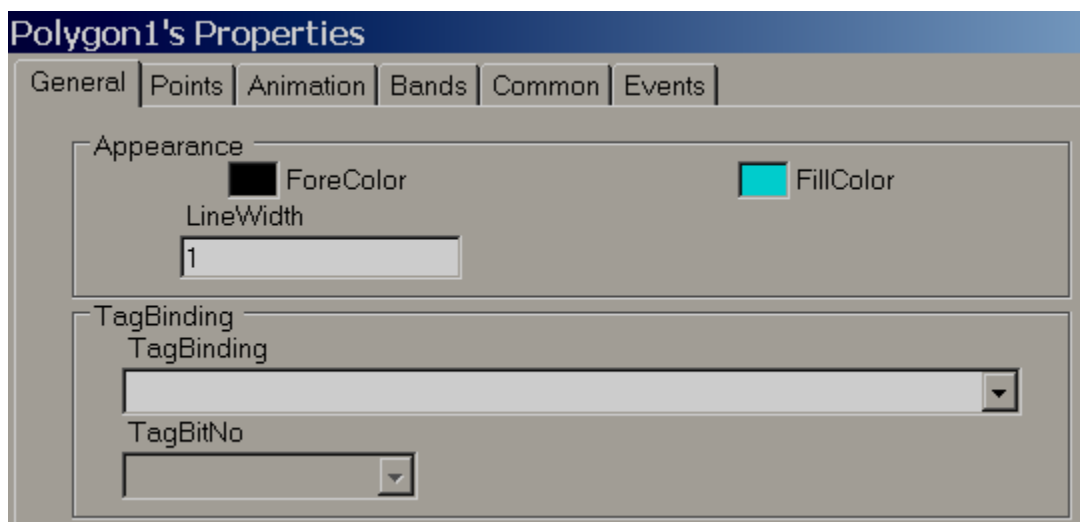

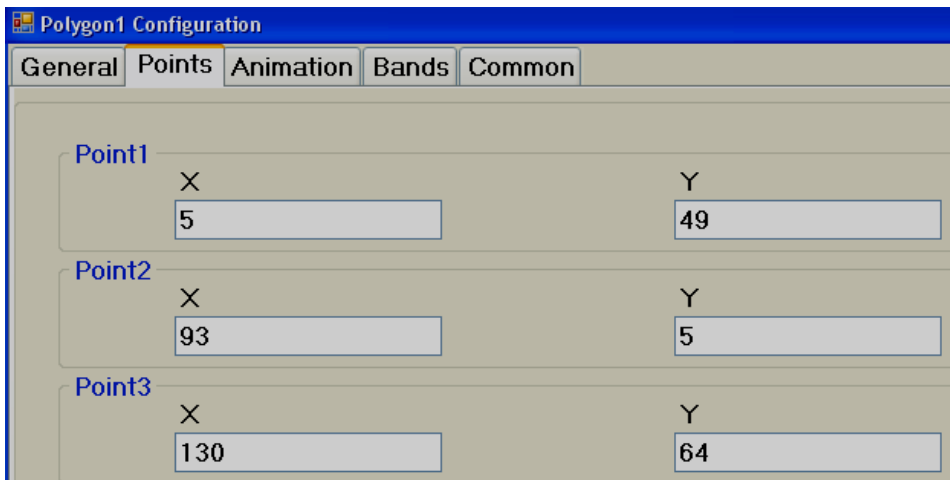

Polygon1 Configuration

General Points Animation Bands Common

Point1

X	5	Y	49
---	---	---	----

Point2

X	93	Y	5
---	----	---	---

Point3

X	130	Y	64
---	-----	---	----

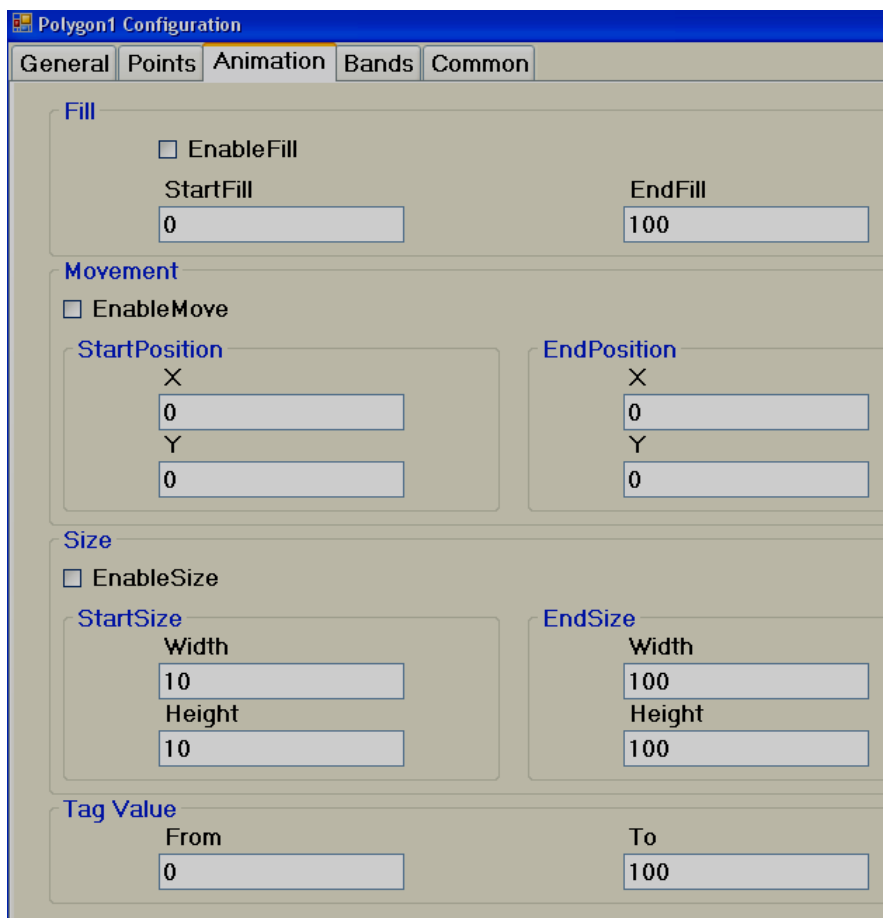

Polygon1 Configuration

General Points Animation Bands Common

Fill

EnableFill

StartFill	0	EndFill	100
-----------	---	---------	-----

Movement

EnableMove

StartPosition		EndPosition	
X	0	X	0
Y	0	Y	0

Size

EnableSize

StartSize		EndSize	
Width	10	Width	100
Height	10	Height	100

Tag Value

From	0	To	100
------	---	----	-----

Animation

This is to do animation with a Polygon in Run Time

Fill

Select "Enable Fill" if filling animation is required on a Polygon object during Run time. When a tag value changes during Run time, it shows the polygon filling with a defined color inside the Polygon object. It's like a bar graph where the filling is within the polygon shape.

Start Fill: Defines a Start value for Fill

End Fill: Defines an End value for Fill

Movement

Used to define a movement position. This is the same as previously explained for the Line object earlier.

Size

Used to define the amount of size increase/decrease. This is the same as previously explained for the Line object earlier.

Tag Value

Select a Tag to be linked with the Polygon object. This is useful if animation is required to be done with the Polygon.

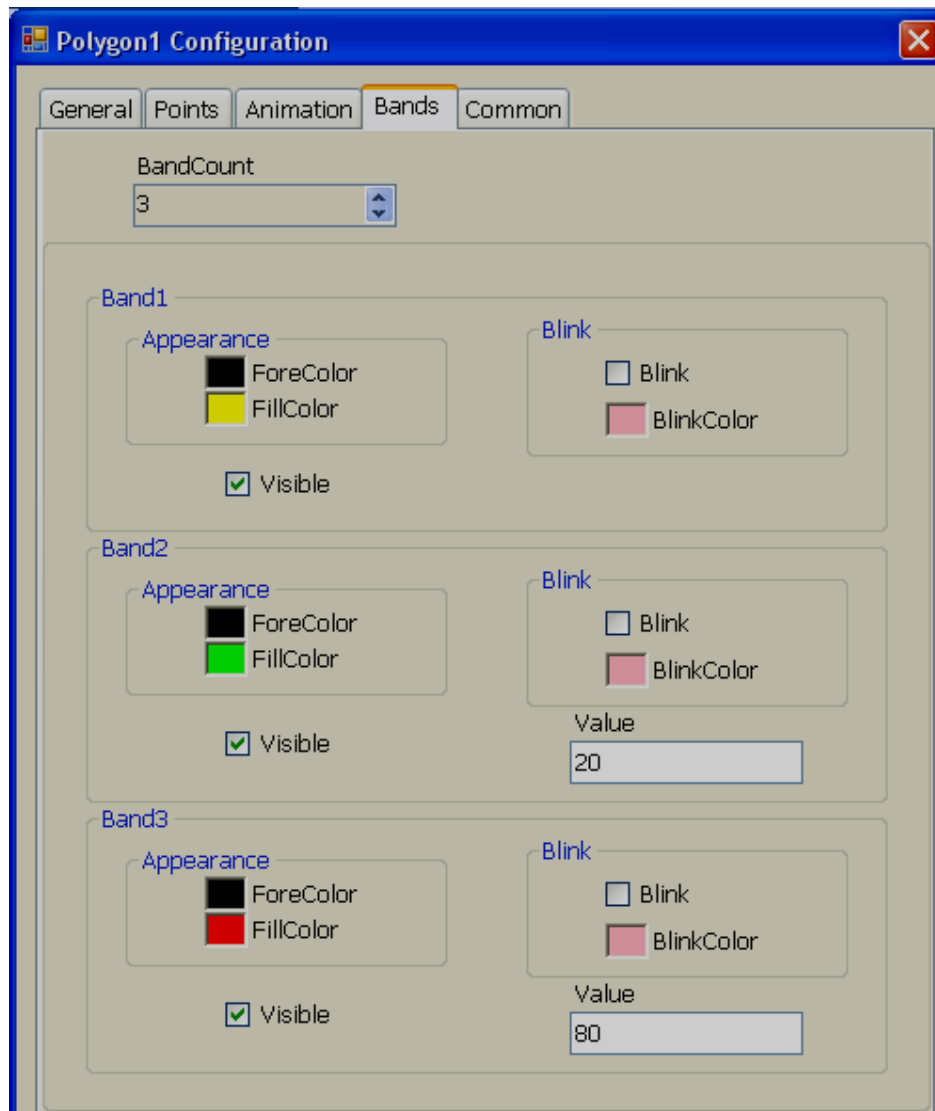

Band editor: A maximum of 32 bands are available.

For example: In the above sample,
If the Tag value is 0 to 20, Polygon fill color = Yellow
If the Tag value is 21 to 80, then, Polygon fill color = Green
If Tag value is above 80, Polygon fill color = RED

If required, it is also possible to configure the blink property and set blink color for any band.

5.3.17.5 Rectangle

Rectangle: Used to draw a Rectangle and do animation during Run time when linked with a Tag.

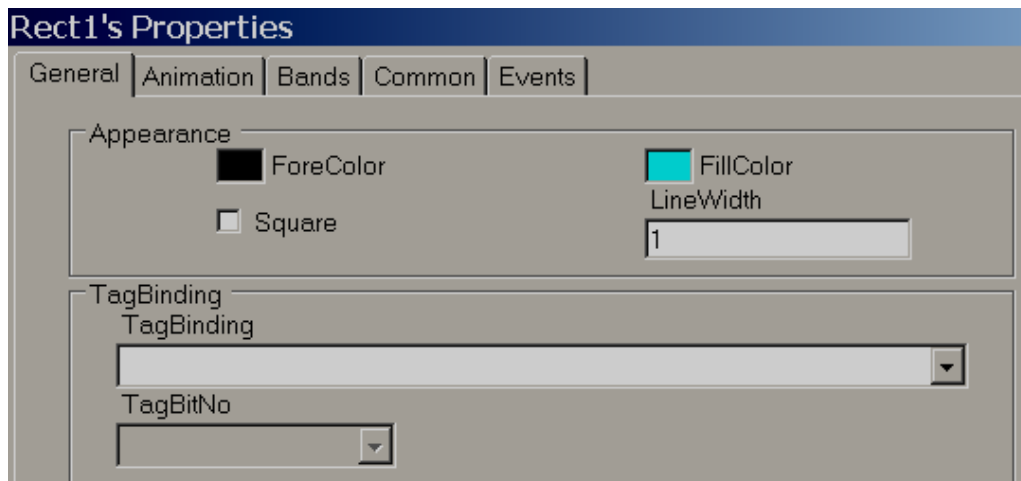

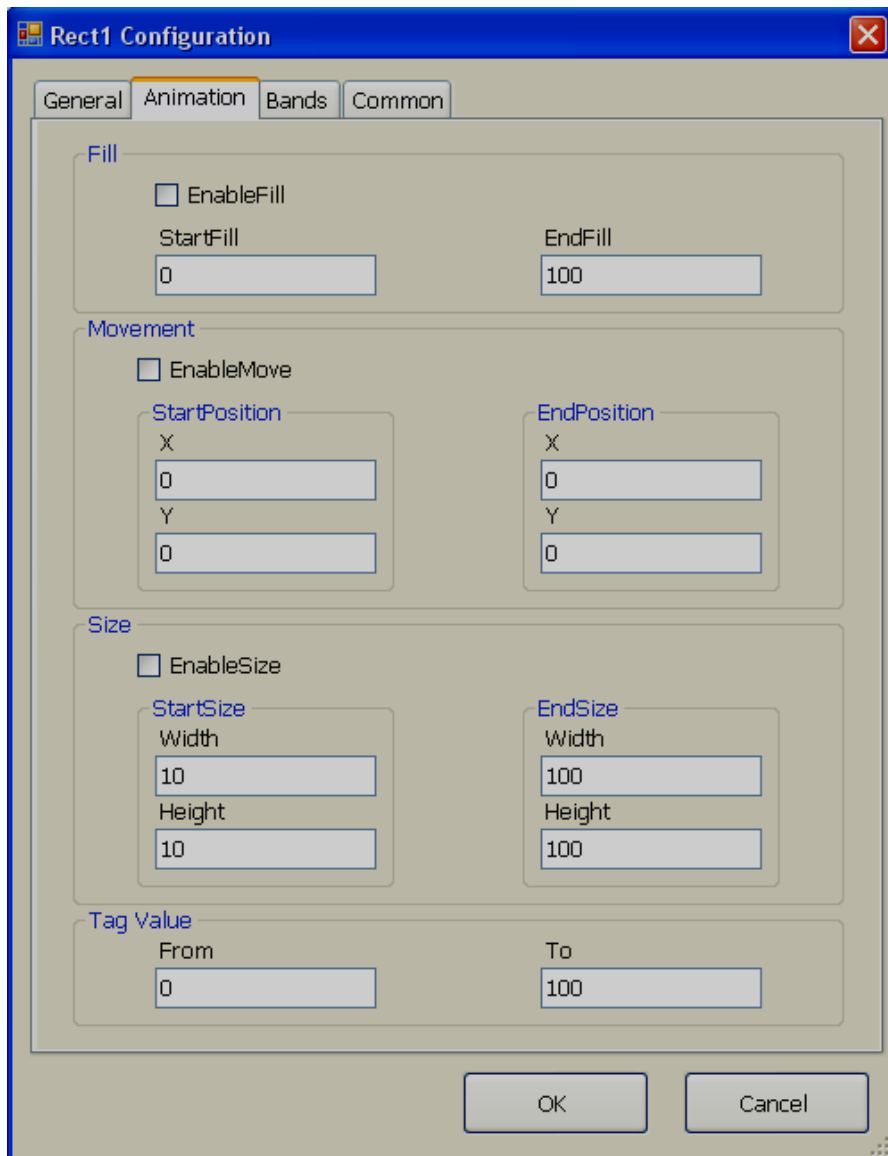

Animation Supported: Fill, Movement and Size

The above features are same as explained for Line and Polygon objects

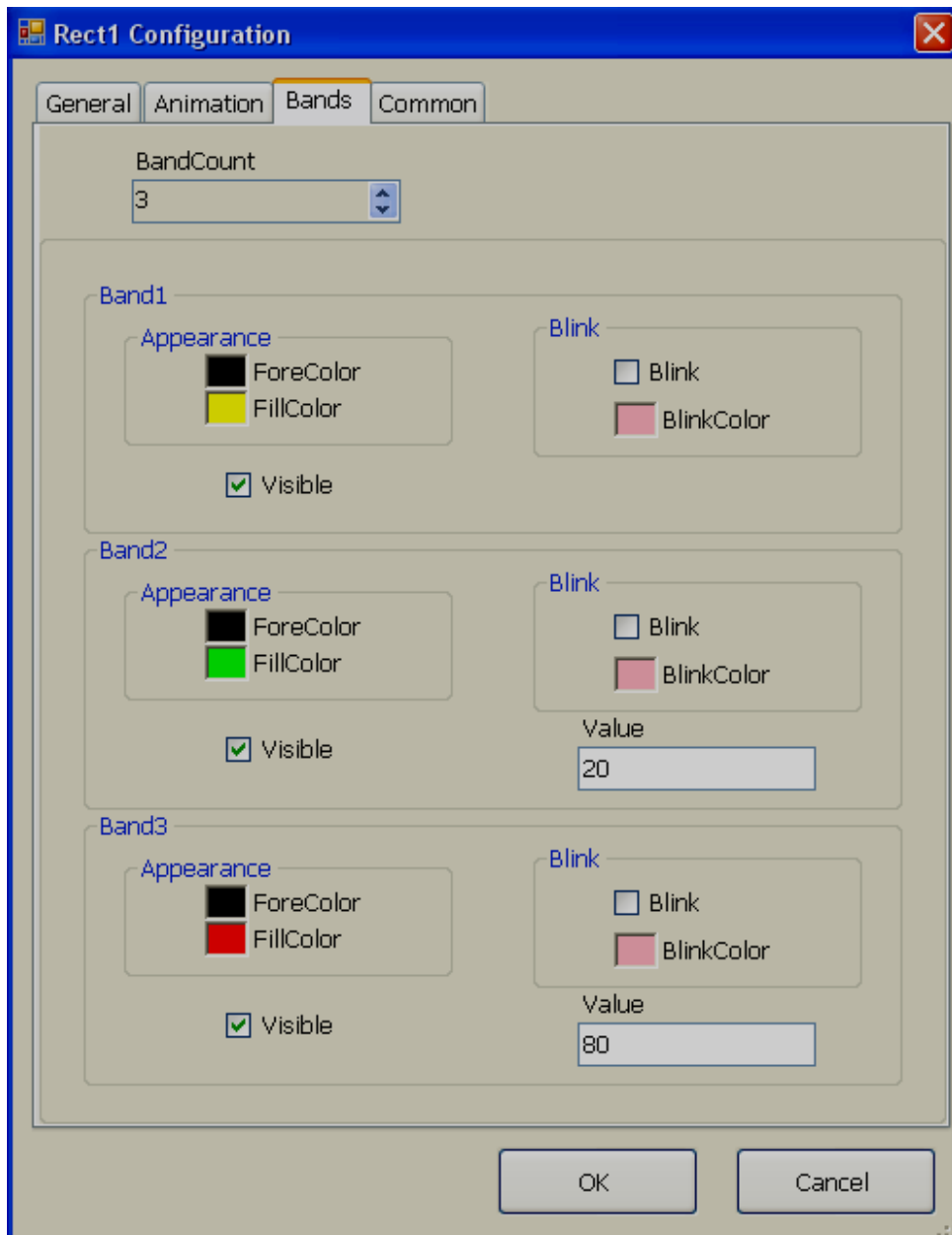

Band editor: A maximum of 32 bands are available.

For example: In the above sample,
If the Tag value is 0 to 20, Rectangle fill color = Yellow
If the Tag value is 21 to 80, then, Rectangle fill color = Green
If the Tag value is above 80, Rectangle fill color = Red

If required, it is also possible to configure blink property and set blink color for any band.

5.3.17.6 Ellipse

Ellipse: Used to draw an Ellipse or a circle and do animation during Run time when linked with a Tag.

The screenshot shows the 'Elliptical1's Properties' dialog box with the 'Appearance' and 'TagBinding' tabs selected. The 'Appearance' section includes a 'Fore Color' button with a black square, a 'Fill Color' button with a cyan square, a 'Line Width' text box containing '1', and a 'Circle' checkbox. The 'TagBinding' section includes a 'TagBinding' dropdown menu and a 'TagBitNo' dropdown menu.

The screenshot shows the 'Elliptical1's Properties' dialog box with the 'Fill', 'Movement', 'Size', and 'Tag Value Range' tabs selected. The 'Fill' section includes an 'Enable Fill' checkbox (checked), 'Start Fill' and 'End Fill' text boxes containing '0' and '100' respectively. The 'Movement' section includes an 'Enable Move' checkbox (unchecked), 'Start Position' and 'End Position' sections, each with 'X' and 'Y' text boxes containing '0'. The 'Size' section includes an 'Enable Size' checkbox (unchecked), 'Start Size' and 'End Size' sections, each with 'Width' and 'Height' text boxes containing '10' and '100' respectively. The 'Tag Value Range' section includes 'From' and 'To' text boxes containing '0' and '100' respectively.

Animation Supported: Fill, Movement and Size

The above features are the same as explained for Line and Polygon objects.

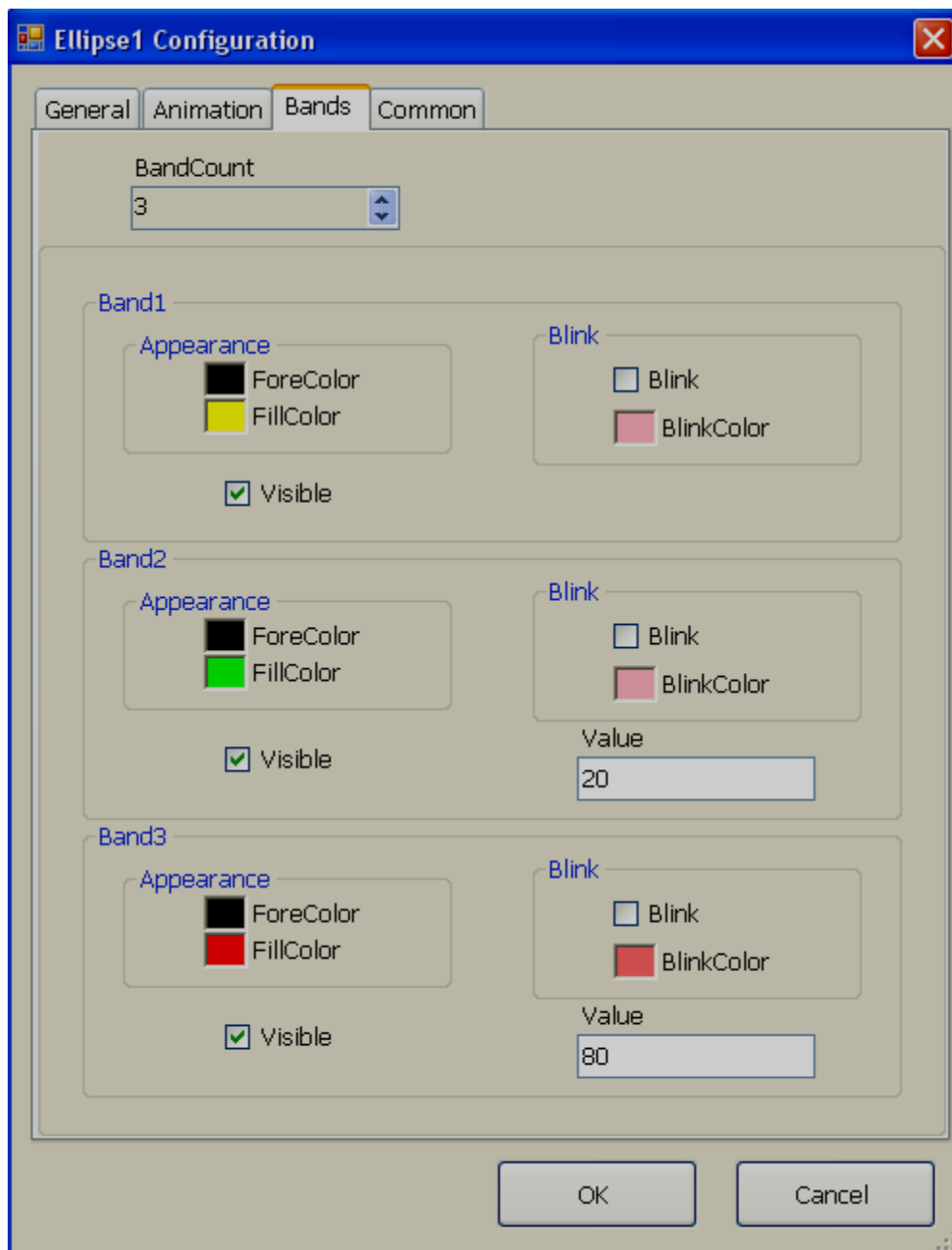

Band editor: A maximum of 32 bands are available.

For example: In above the sample,

If the Tag value is 0 to 20, Ellipse fill color = Yellow

If the Tag value is 21 to 80, then, Ellipse fill color = Green

If the Tag value is above 80, Ellipse fill color = Red

If required, it is also possible to configure blink property and set blink color for any band.

5.3.17.7 Arc

Arc: Used to draw an Arc and do animation during Run time when linked with a Tag.

The screenshot shows the 'Arc1's Properties' dialog box with the 'Appearance' and 'Shape' tabs selected. The 'Appearance' section includes a 'ForeColor' color picker (black) and a 'LineWidth' text box containing the value '1'. The 'Shape' section includes a 'StartAngle' text box containing '0' and a 'SweepAngle' text box containing '60'. The 'TagBinding' section includes a 'TagBinding' dropdown menu and a 'TagBitNo' dropdown menu.

Start Angle: Defines the start angle.

Sweep angle: Defines the end angle

The screenshot shows the 'Arc1's Properties' dialog box with the 'Movement' and 'Size' tabs selected. The 'Movement' section includes a checked 'EnableMove' checkbox, a 'StartPosition' group with 'X' and 'Y' text boxes containing '0', and an 'EndPosition' group with 'X' and 'Y' text boxes containing '100' and '0'. The 'Size' section includes an unchecked 'EnableSize' checkbox, a 'StartSize' group with 'Width' and 'Height' text boxes containing '10', and an 'EndSize' group with 'Width' and 'Height' text boxes containing '100'. The 'Tag Value Range' section includes a 'From' text box containing '0' and a 'To' text box containing '100'.

Supported Animation: Movement and Size

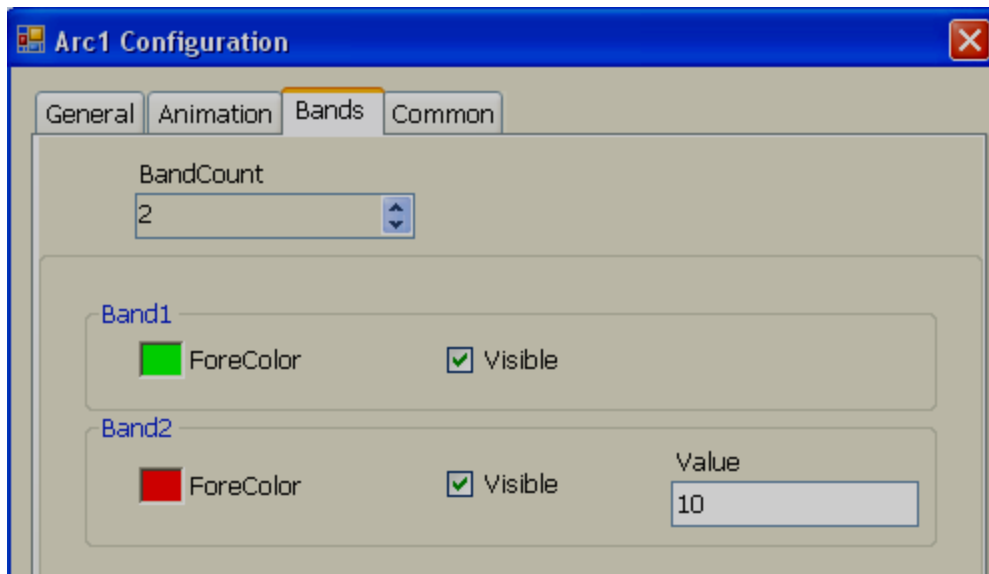

Band editor: A maximum of 32 bands are available. Band editor for “Arc” is the same as explained for the “Line” object earlier.

5.3.17.8 Table

It is used to draw a table during design time by specifying number of rows & columns. All rows/columns will have an equal width and height. It is possible to place labels on rows (Linked with Tags) for displaying process values to appear like a tabular column. User can edit properties via the GUI dialog or Property grid as per convenience. After dragging/dropping the object to the screen, double click on the object to open GUI dialog.



While working with a Table, in page properties, select Snap to Grid = False so that it will be easy to place labels/textboxes in required positions easily.

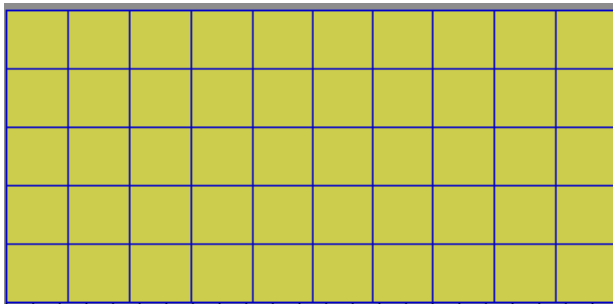

Drag/Drop Table from Basic objects to the screen, then double click on Table. The following screen will open.

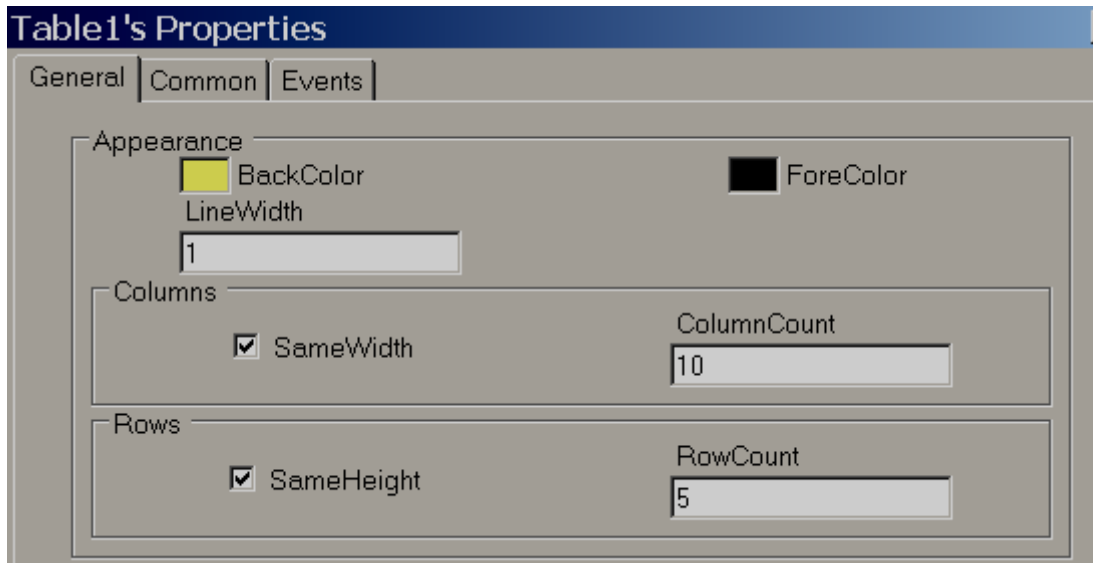

Note: Deselect “Same Width” to adjust column width in the Table

Note: Deselect “Same Height” to adjust Row height in the Table

Property grid

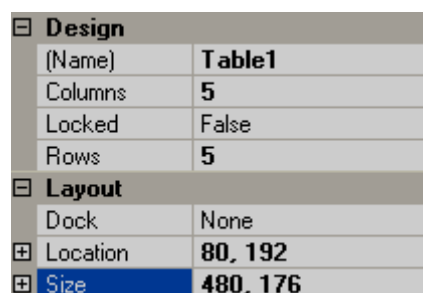
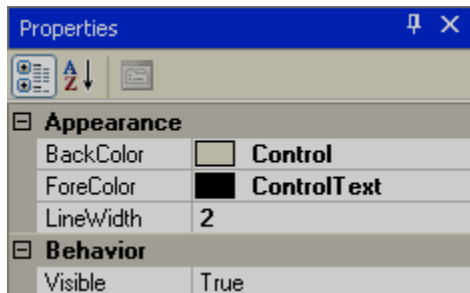

Properties

Back Color: It is the back color of the table

Fore Color: It is the color for the lines of the table

Line Width: It is the width of the lines of the table

Columns: Defines the number of columns in the table

Rows: Defines number of rows in the table

Name: The unique name for the table in a specific page

Locked: Used to determine if table is locked for further moving and resize in design time and you can set this in property grid.

5.3.17.9 Numeric Up/Down

Numeric Up/Down is a Graphical User Interface widget that allows the user to increase or decrease the value of a tag by pressing up or down arrows during Run time, or to enter a numeric value directly via a keypad. Users can edit properties via GUI dialog or Property grid for convenience. After drag/drop of a numeric up/down object to the screen, double click on the object to open GUI dialog.

Every Numeric Up/Down button should be linked with an **Analog Tag**.



Except the Up/Down arrow, if a user presses another area of the Numeric Up/Down component in the recorder during Run time, a numeric keypad will open. The user can then enter a numeric value directly. The numeric keypad will not appear in the PC during Online/Offline simulation, you can use the keyboard directly to enter a numeric value.

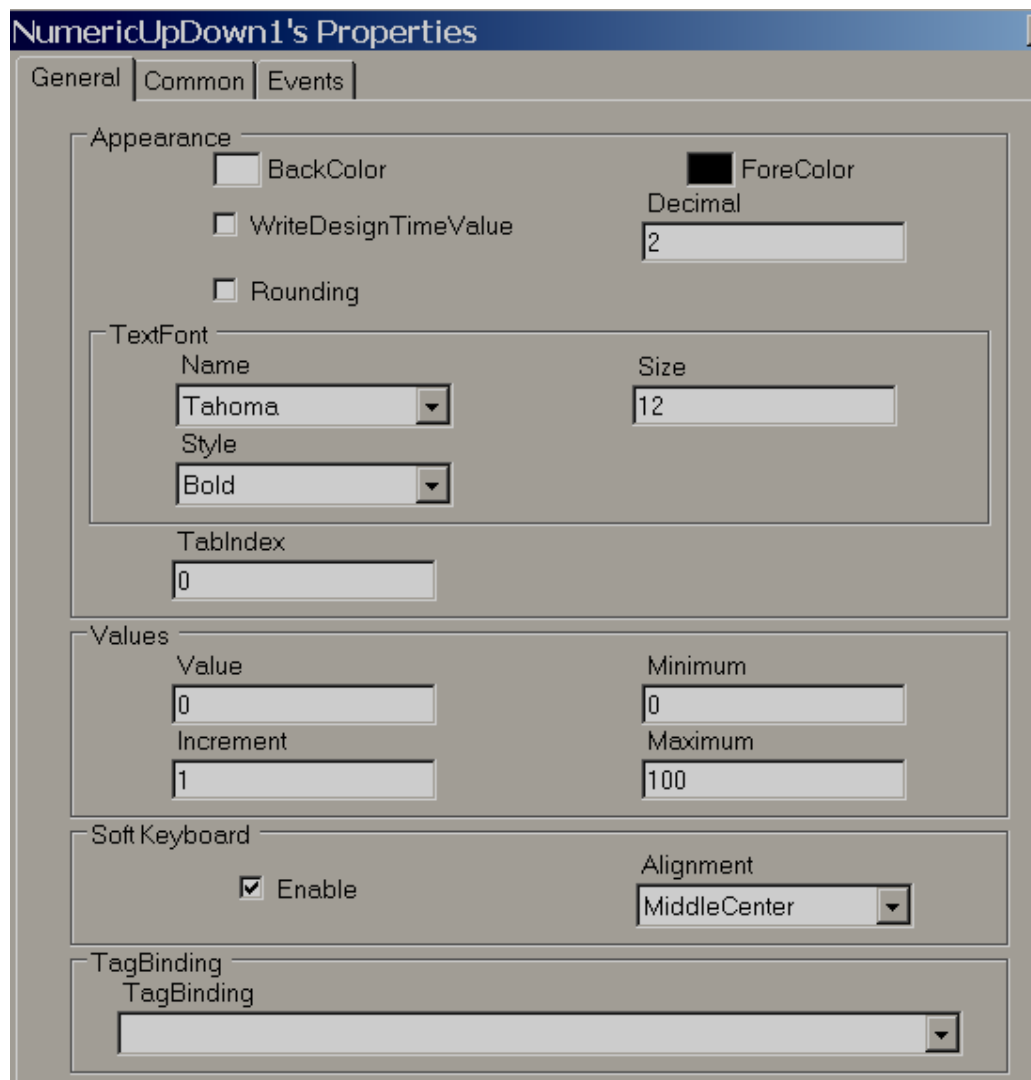

Increment: Select the value to be incremented/ decremented each time when the up/down arrow is pressed during Run time.

Properties

Write design time value: If selected, it writes value available at “Text” during design time and also during run time replacing the default value defined in the Tag data base.

Rounding: Rounds to nearest value

Decimal: Enter the number of decimal points

Value: Current Tag value. It is used to enter a value during design time and to check how a value is displayed during Run time.

Increment: Value to be incremented during Run time after pressing Up/Down button.

Minimum: Defines the minimum value

Maximum: Defines the maximum value

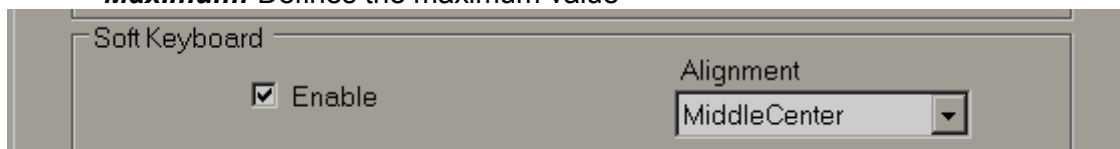

Soft keyboard: If enabled, it is possible to control the keypad appearance during run time. For example, if alignment is selected as Middle center, then, when keypad appears in run time, it will be located to Middle center in screen

Events: Defines events to be executed when the operator presses the Up/Down arrow and changes the value during Run time.

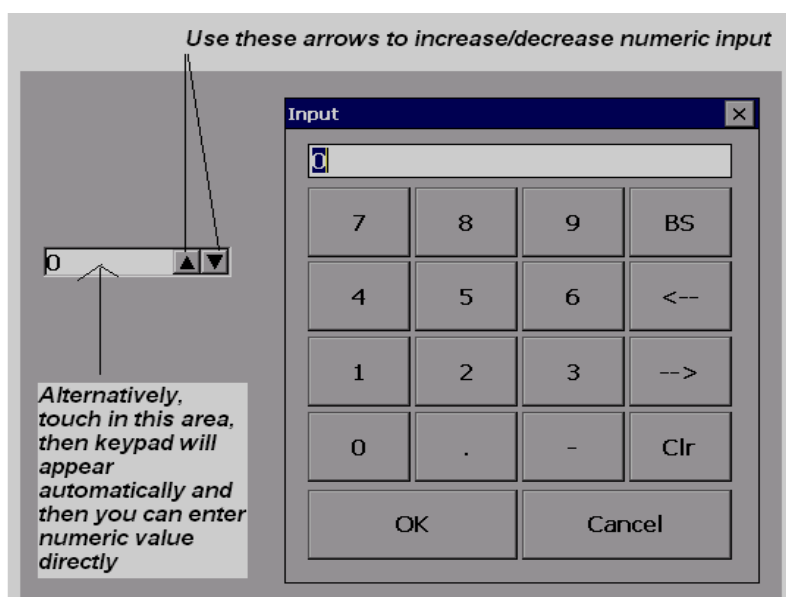

5.3.17.10 Digital LED

This object is used to view a process value in a digital format. Generally, it is linked with an analog type tag (example: an analog input tag at a PLC, which is received as 4-20 mA signals from field transmitters to define things like Temperature, Pressure, Flow, Level, Position etc...)

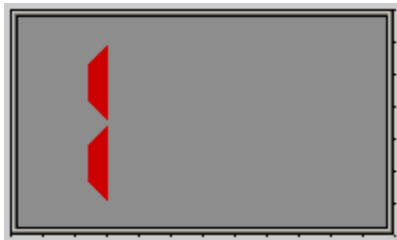

For common properties like Back Color, Bevel, ect., please refer section “Common Properties

DigitalLED1's Properties

General | Common | Events

Appearance

BackColor Value: 1

Bevel

InnerBorder OuterBorder

Style: DoubleRaised

Digits

ActiveColor InactiveColor

DigitHeight: 80 DigitWidth: 40

DigitSpace: 3 SegmentSpace: 1

SegmentThickness: 4

Decimal: 0 Rounding

TagBinding

TagBinding: [Empty]

Property grid

Digits		Red,80,3,40,Color [Silver]
ActiveColor		Red
DigitHeight		80
DigitSpace		3
DigitWidth		40
InactiveColor		Silver
SegmentSpace		1
SegmentThickness		10

Properties

Back Color: Defines background color for the component

Inner border: Select if inner border is required for the component

Outer border: Select if outer border is required for the component

Style: Defines border style. Available options are Single, Double, Raised, Lowered, Double Raised, Double Lowered, Frame Raised and Frame Lowered

Active Color: Defines Active Color of Segment for Digits

Inactive Color: Defines color of inactive segments. In the seven-segment LED display, some segments may be active and some other segments may be inactive depending on numeric values.

Digit Height: Defines height of digits

Digit Width: Define width of digits

Digit Space: Defines the space between digits

Segment Space: Defines the space between segment to segment for digits

Segment Thickness: Defines thickness of segments for digits

Decimals: Defines the number of decimal points

Tag Binding: Selects the Analog Tag of process value

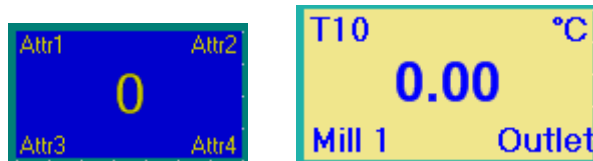

5.3.17.11 Digital Box

Digital Box is a Graphical User Interface widget that displays a digital tag value along with four predefined labels as attributes for the process value in Run time.

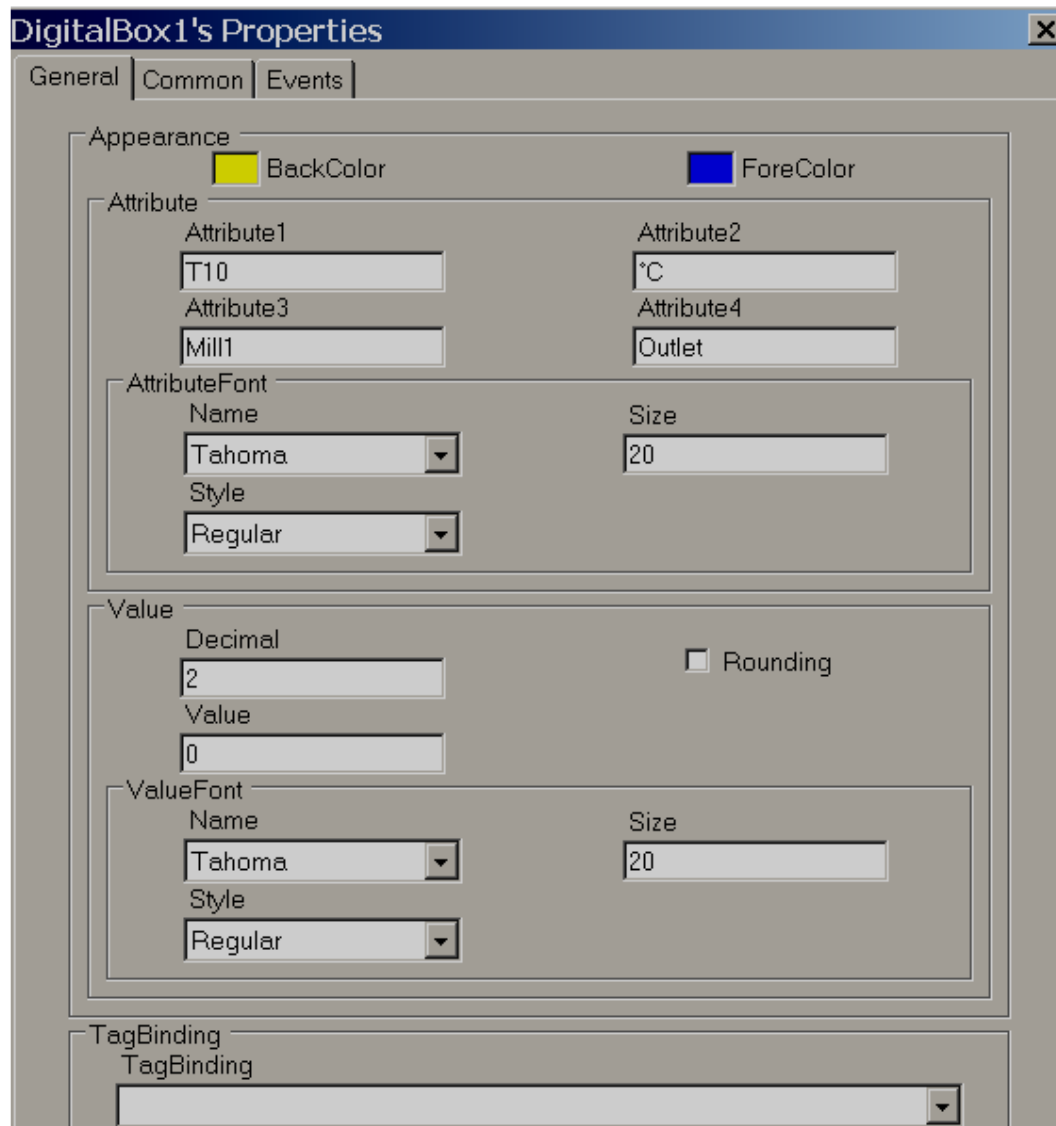

Digital Boxes are normally used with **Analog** tags to display process values like Temperature, Pressure, Flow etc. They also allow 4 different labels as attributes for displaying tag related information.



Appearance	
Attribute1	T10
Attribute2	*C
Attribute3	Mill 1
Attribute4	Outlet
AttributeFont	Microsoft Sans Serif
BackColor	 Khaki
Decimal	2
ForeColor	 Blue
ValueFont	Arial,20,Bold

Behavior	
Value	0
Visible	True
Data	
TagBinding	Tag3
Design	
(Name)	DigitalBox1
Locked	False
Layout	
Dock	None
Location	176, 224
Size	256, 112

Properties

Attribute1: attribute to be displayed at Top left side of Digital Box

Attribute2: attribute to be displayed at Top Right side of Digital Box

Attribute3: attribute to be displayed at Bottom Left side of Digital Box

Attribute4: attribute to be displayed at Bottom Right side of Digital Box

Attribute font: Define font for attribute, select type font, and size of font and style of font. Styles include Regular, Bold, Italic, Underline, and Strike out.

Back color: Defines background color

Fore Color: Define fore-color for the font

Decimal: Defines number of decimal places for the value to be displayed

Value font: Used to adjust the size of the display process value font, select type of font, size of font and style of font. Styles include Regular, Bold, Italic, Underline and Strike out.

5.3.17.12 Text box

Used to Read/Write Alpha numeric text in Run time. It can be linked with any type of tag.



If the object is linked with String type tag, an alpha-numeric keypad opens during Run time if a user touches the object. If the object is linked with an Analog or Digital tag, a numeric keypad opens during Run time if a user attempts to touch the object. If a digital tag is used, make sure “decimal” is set to 0.

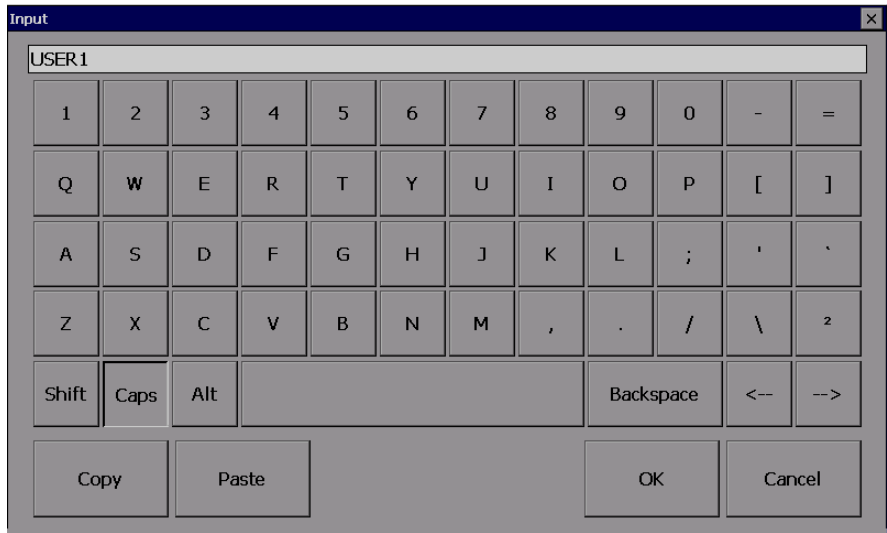

Alpha numeric keypad

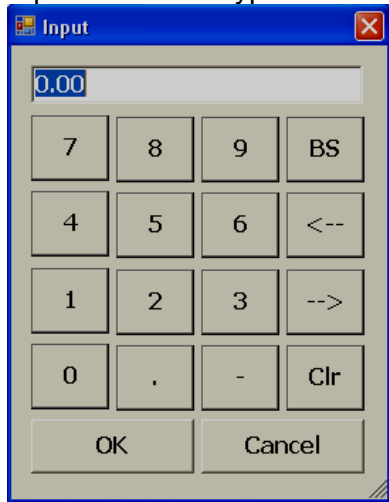

Numeric keypad

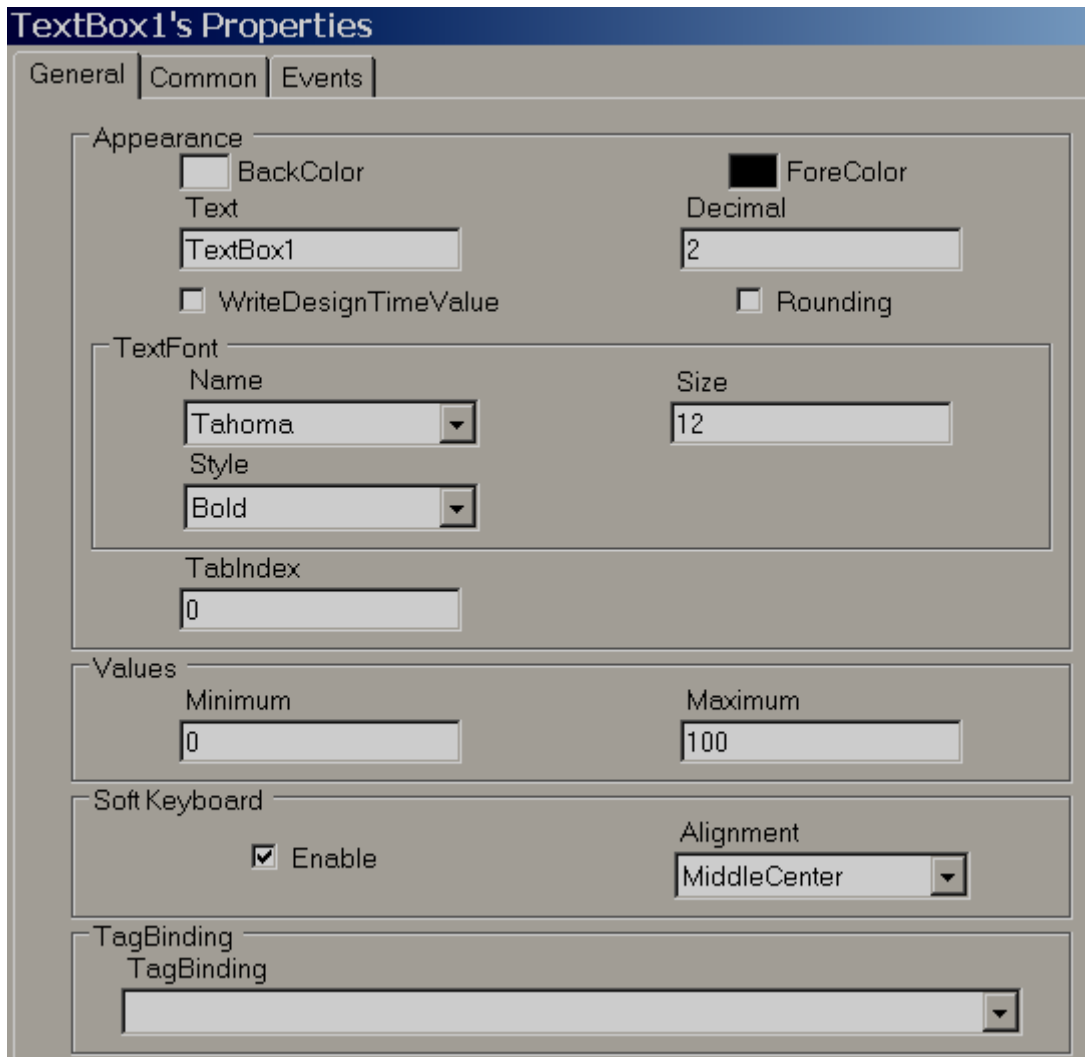

Note: For common properties of all components, please check the beginning of this section.

Write design time value: If selected, it writes the value available at “Text” during design time and also during run time replacing the default value defined in the Tag database.

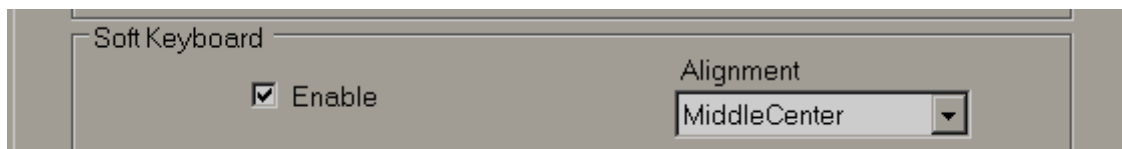

Soft keyboard: If enabled, it is possible to control the keypad appearance during run time. For example, if “alignment” is selected as Middle center, then, when the keypad appears during run time, it will be located in the middle-center of the screen

Appearance	
BackColor	<input type="checkbox"/> White
Decimal	2
ForeColor	<input checked="" type="checkbox"/> ControlText
Password	
Text	TextBox1
TextFont	
	Tahoma,12,Bold
Behavior	
Visible	True
Data	
TagBinding	Tag1

Design	
(Name)	TextBox1
Locked	False
SecurityLevel	0
Events	
Changed	
Layout	
Dock	None
Location	
	96, 96
Size	
	112, 24
Misc	
WriteDesi	False

5.3.17.13 Label

The “Label” object is used to write a simple line of text for user information in the screen. Example: Tag name, Pump number display etc. It is also used to display process values (read only) to operators if linked with a Tag.

P102

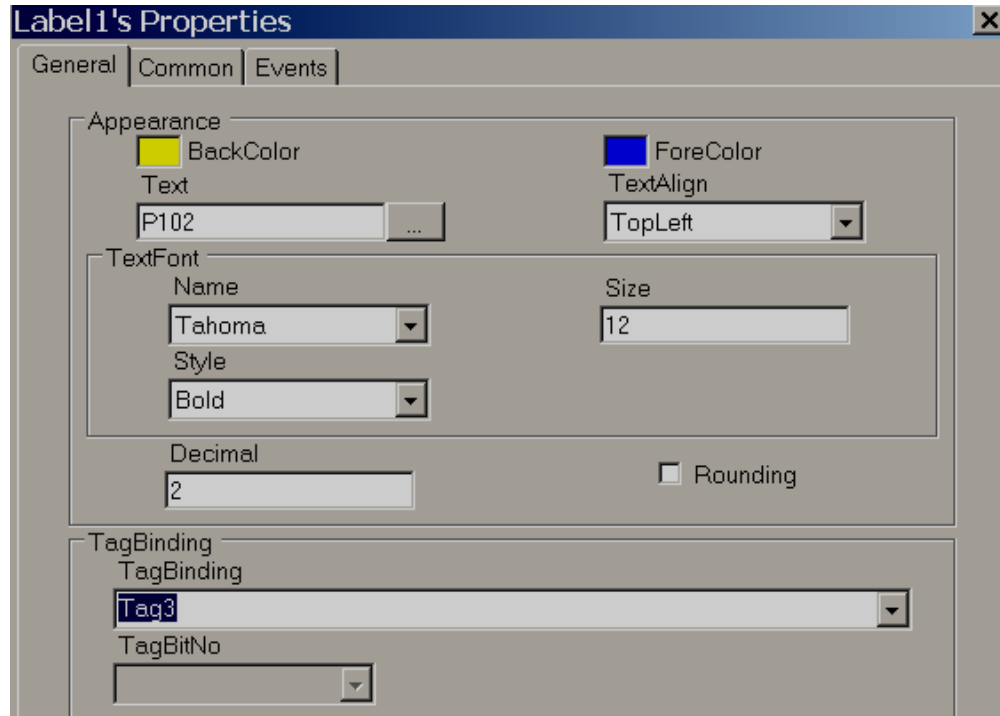

Properties...	
Appearance	
BackColor	Yellow
Decimal	2
ForeColor	Blue
Rounding	False
Text	P102
TextAlign	TopLeft
TextFont	Tahoma,12,Bold
Behavior	
Enable	
Visible	

Data	
TagBinding	Tag3
Design	
Name	Label1
Events	
Clicked	
Layout	
Location	224;126
Size	112;38

Note: For common properties of all the components, please check beginning of this section.

Properties

Text: Defines text associated with this component and it should be entered at design time only.

Text Align: It is for Alignment of text. Available options include Top Left, Top Center, Top Right, Middle Left, Middle Center, Middle Right, Bottom Left, Bottom Center and Bottom Right

Text Font: Defines font for text including type of font, size of font and style of font. Styles include Regular, Bold, Italic, Underline and Strikeout.

Tag Binding: Select the Analog Tag of a process value

Decimal: Defines the number of decimal points

5.3.17.14 Date and time Label

1/20/2010 PM 4:43:03

Used to display Date and Time in screen.

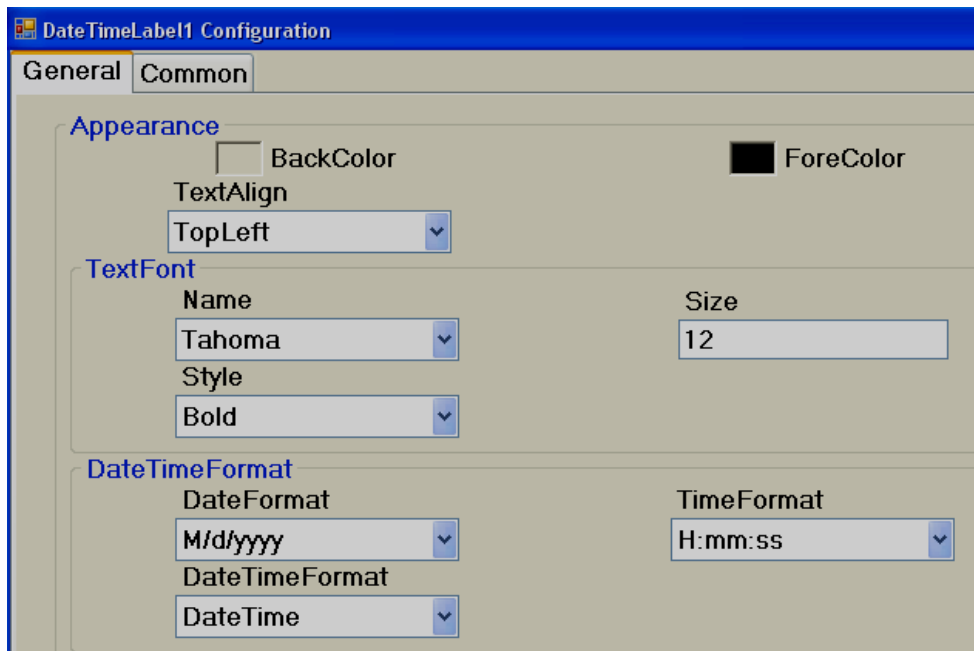

If date and time is required in more than one screen, it is better to create a screen and select the screen type as “Template”, and then link this template to all other required screens to display Date and Time automatically. This is more efficient than keeping Date and Time label in more than one screen, since it uses less memory.

5.3.17.15 Button



A Button is commonly used to perform an action after operator presses it with their finger, or by clicking using a mouse during Run time.

Generally, “Button” is used to turn ON a bit, Turn OFF a bit etc. when used with Digital type tags. Example: Start Pump, Stop pump etc.

Three kinds of “Events” are supported for a button. Clicked, Pressed and Released. Several functions are supported which can be configured from “Events” and all the functions are covered in next section “Function editor”.

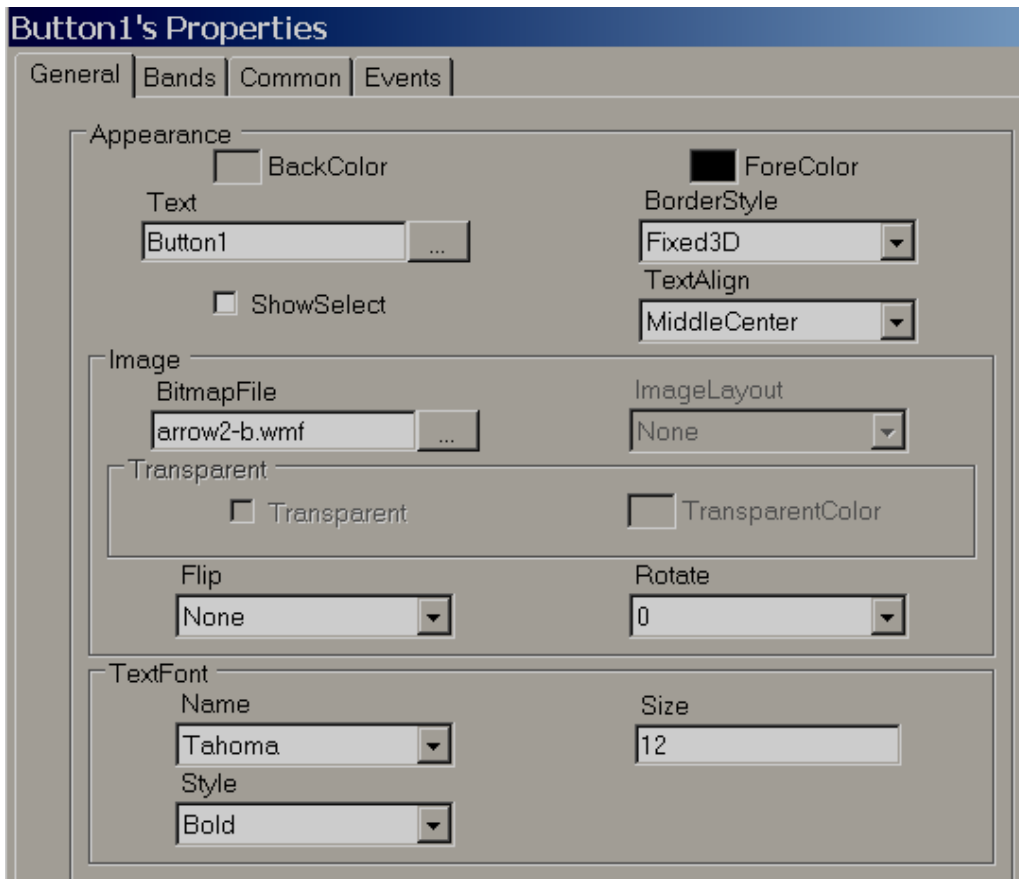

Properties

Back Color: Selects Back color for the object. Also, it is possible to select transparent mode if required. *Firmware V1.20 onwards.*

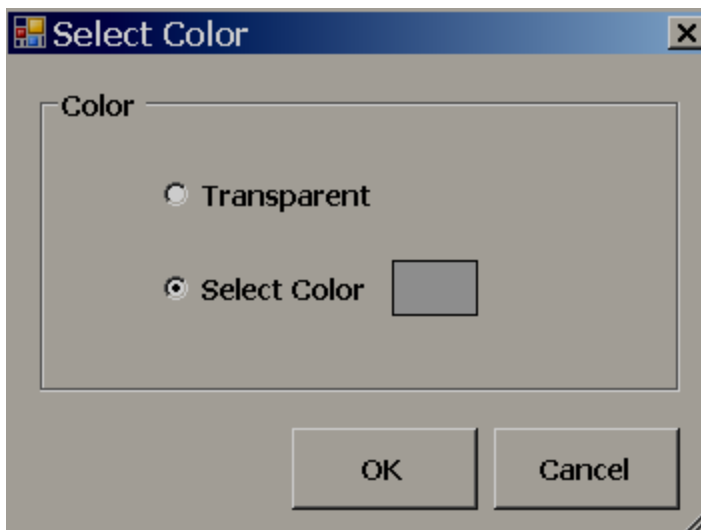

Text: Defines required text to be displayed on the object. *It is also possible to enter multiline text from firmware V1.20 onwards*

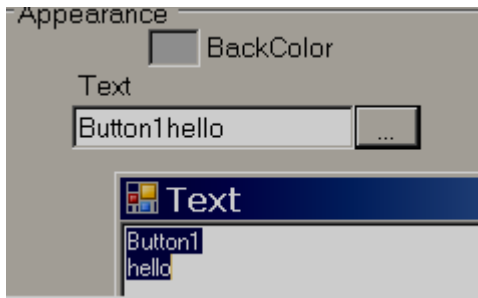

Show select: True/False. If it is selected, then, when the operator presses this button, it will show a dotted line just inside the button. When the operator presses another button, it automatically shows selected “show” status to latest button and deselect “select” status for previous button pressed by the operator.

Border Style: Defines border style. Available options include none, fixed single and fixed 3D

Image: Selects the Image to be displayed on the object. Image can be selected from either Basic symbols or Symbol factory, or a custom image can be used if they are formatted as bmp, wmf, jpg, gif or png.

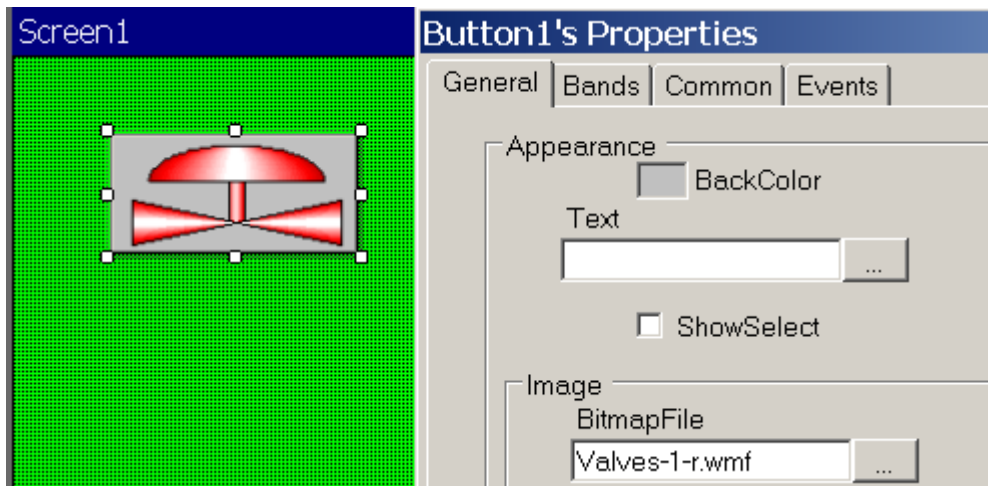

Text font: Define the font including name of font, size of font and style of font

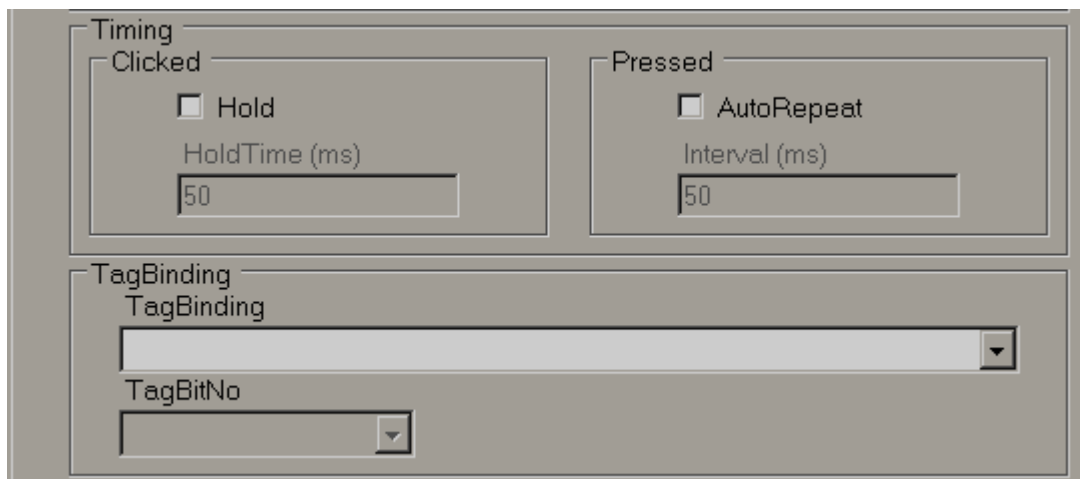

Timing: This is an advanced feature and used to make sure operator action is properly received by PLC when the PLC has a large scan time.

Hold time: This is generally applicable for a “Clicked” event. This keeps executing the action defined at the “Clicked” event for the time defined at hold time. We suggest using holding time greater than the PLC scan time.
Example: 300 msec.

Example:

Push button Function

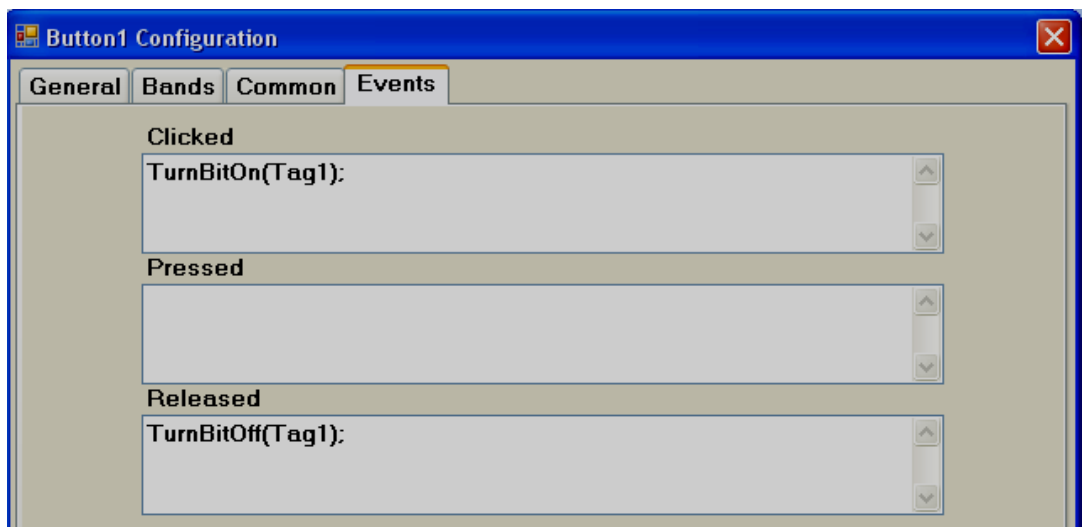

Example: Operator presses button for only 200 msec. When operator clicks the button, Tag1 = 1. When operator releases the button, Tag1 = 0, holding time = 1000 msec.

Since holding time is set for a clicked action, the released action “TurnBitOff” will be executed only after completing 1000 msec, not immediately after the operator releases the button. In this case, if the PLC scan time is 800 msec, the operator click action will be detected properly because the button will remain active for 1000 msec.

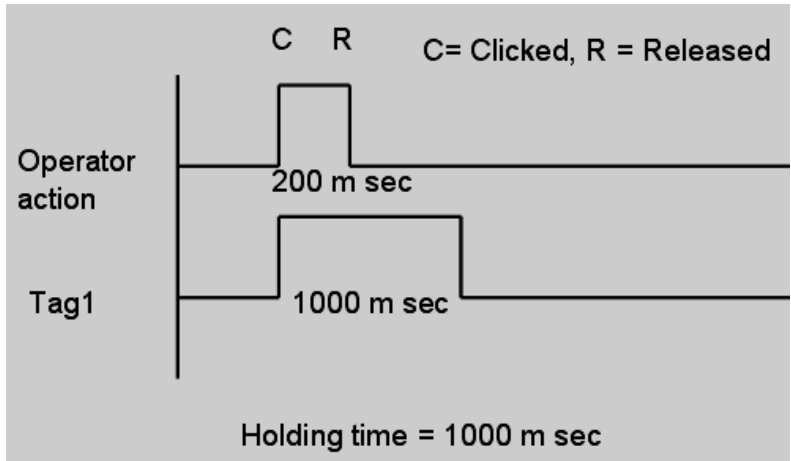

Auto Repeat & Interval time: This is generally applicable for a “Pressed” event. It is to repeat the action defined at the “Pressed” event as per the set interval time.

Example: When operator keeps the button pressed, the set point should be incremented by 1 for every 1 second.

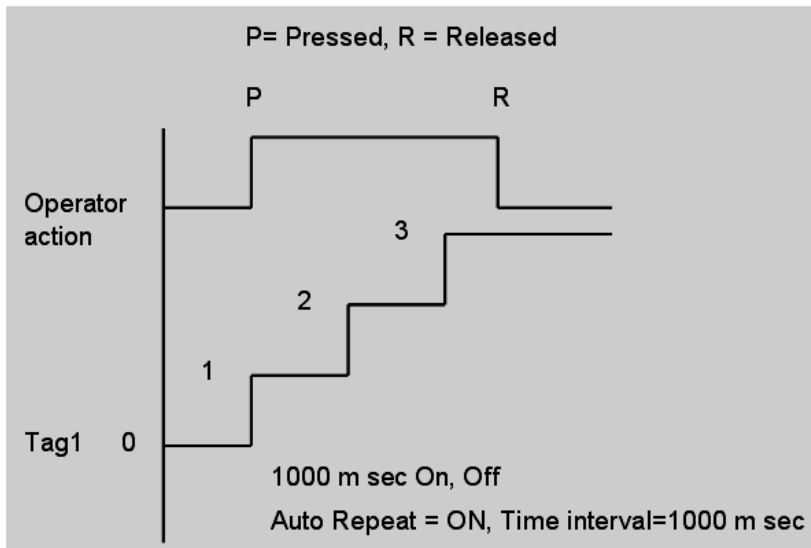

Auto repeat with time interval and holding time cannot be used together.

Tag binding: Select the tag that should be linked to the button to show a different display during run time based on configuration available at Band editor. Any of the configured Analog or Digital tags can be selected.

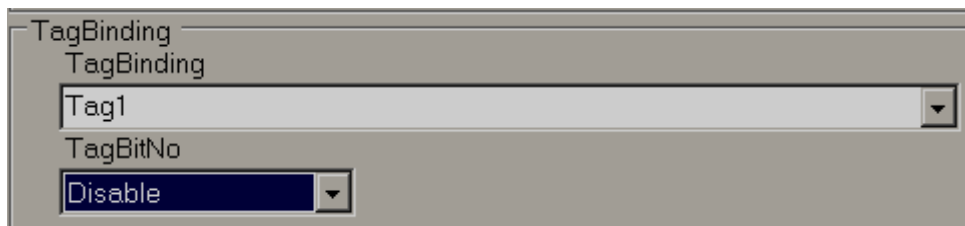

If Tag1 is an Analog Type (32 bit), it is also possible to show a different display based on individual bits. By default, it is disabled. You can select the bit from the combo box and then configure the band editor per project requirements.

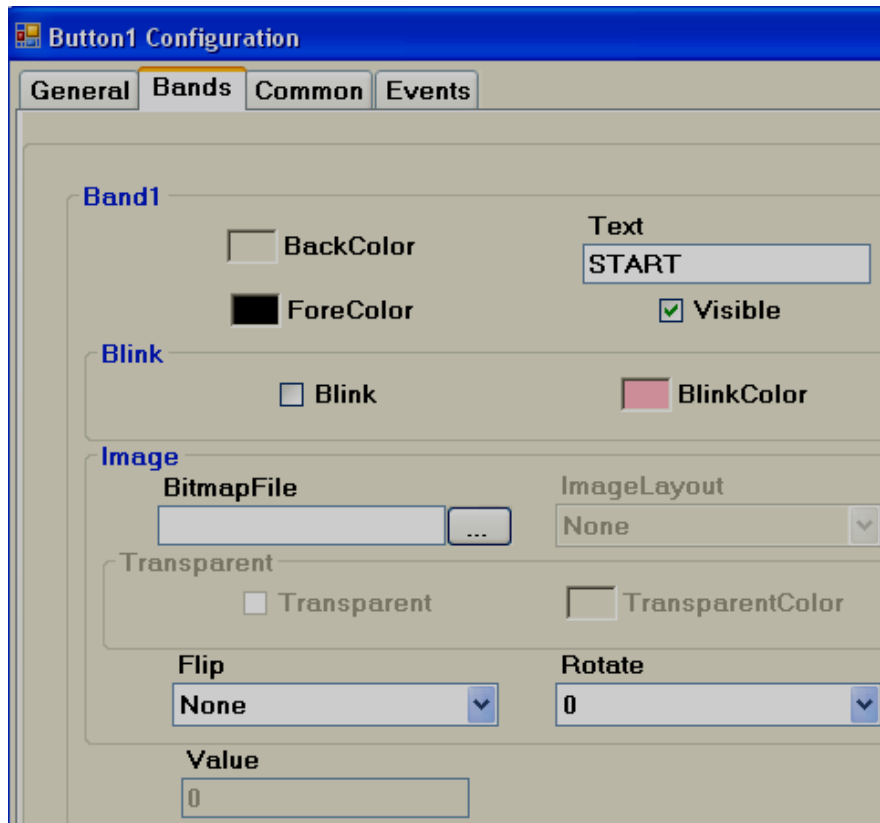

Bands: Defines bands for the button.

Back color: Defines the back color for the selected band

Fore color: Defines the fore color to appear for selected band in run time

Text: Define the text to be displayed for selected band in run time

Visible: Controls if the button is visible

Blink: Select if blink is required when the tag value reaches a selected band during run time. If yes is selected, it allows the user to enter a blink color.

Bitmap file: Select the image to be displayed on button when tag value reaches this band in run time.

For example: When Tag1=0, show Red colored motor symbol on the button.

When Tag1=1, show Green colored motor symbol on the button.

Note: Two different symbols are required for the above example

Bmp, wmf, jpg, gif and png types are supported. If the selected file is different than wmf, then, it is also possible to select Image layout and transparent options.

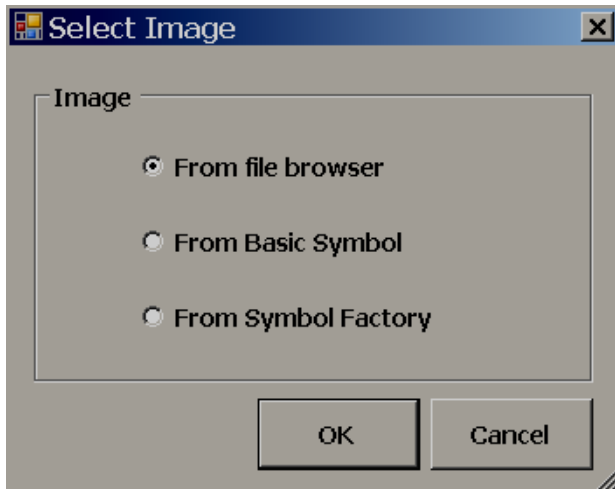

From File browser. To select image from a specified location

From Basic Symbol: To select images from the free basic symbols (*.wmf format) available in Recorder editing software.

From symbol factory: It allows the user to select symbols from the symbol factory (in wmf format).

Image layout: None, center and Stretch options are available. Stretch means the selected bitmap will be stretched to the size of the button.

Note: If a bitmap has poor resolution, when stretch is used, it may show a low quality image in screen.

Flip: Used to flip a button. This needs to be configured during design time. Available options include None, Horizontal, Vertical and Both.

Rotation: Used to rotate the button at predefined angles. This needs to be configured during design time. Available options include 0°, 90°, 180° and 270°.

Value: Defines the maximum range of the selected band. Low range will be the value defined at the previous band. There is no need to enter any value for band 1 as its value is 0 which is low range.



If the button is linked with a Digital Tag, then, in the band editor, it will show only two bands for value 0 and 1. When a button is linked with an Analog tag, it is possible to configure up to 32 bands for showing different states of button based on value of tag. It shows statuses similar to word lamp.

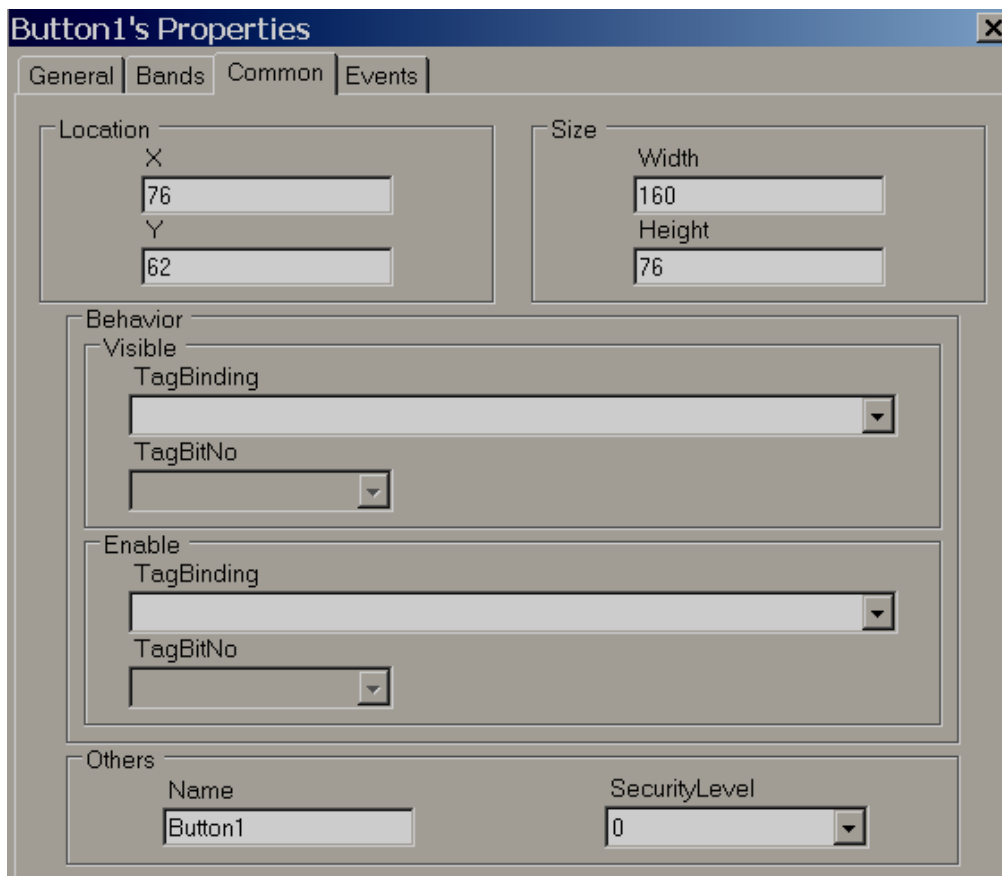

Security control: Defines security level for the button. It allows the user to operate the button only when operator security level is equal to or more than security level defined here.

Please refer section “Security” at Project explorer for more information about security features.

Events

Clicked: Define the action that happens when user presses button during Run time. If required, it is possible to configure a holding time for this action.



Holding time is a very useful function. If the PLC has a large scan time, sometimes the operator “clicked” action will be not detected by the PLC. In this case, it is possible to have a hold time for a “clicked” event so that operator action will be continuously present for the time defined at “holding”, such that the PLC will receive the operator action properly.



If the operator touches a button and releases his/her finger instantly, it is called a “Clicked” action. During this time, a total of three actions will be executed. Click, Pressed and Released



Case-1

Holding time = 0

In above example, Tag1 value becomes 3

Case-2

Holding time = 5000m sec

In the above example, if the scan time for Tag1 is 1000m sec, the Tag1 value becomes approximately 8.

When the button is clicked, the “Clicked” and “Pressed” event action occurs, and the Tag1 value becomes 2. Since the holding time is 5 sec, for the next 5 seconds, the Tag1 value is incremented by 1 each second. So, Tag1 value becomes 7. When the button is released, Tag1 value is incremented by 1 again, so it becomes 8.

The above example is for illustration only to understand about events for the button object.

Pressed: Define the action that happens when a user continuously presses on a button. If required, it is possible to configure Auto repeat and interval time for this action.



Once an operator touches a button, the “clicked” event will be executed first. If the operator keeps holding the button continuously, the “pressed” action

will continuously be executed. When the operator releases their finger, the “released” action will be executed.

Auto repeat: On, Time interval=1000 m sec. In this example, the Tag1 value will first increment by 1, then it will keep incrementing by 1 once every 1000 m sec. as long as the operator presses the button. The Tag1 value will also be incremented by 1 when the operator releases the button.

Released: Defines the action when the user releases the button

Switch Function

With this function, two buttons are required. One button to turn a tag ON, and a second button to turn a tag OFF.

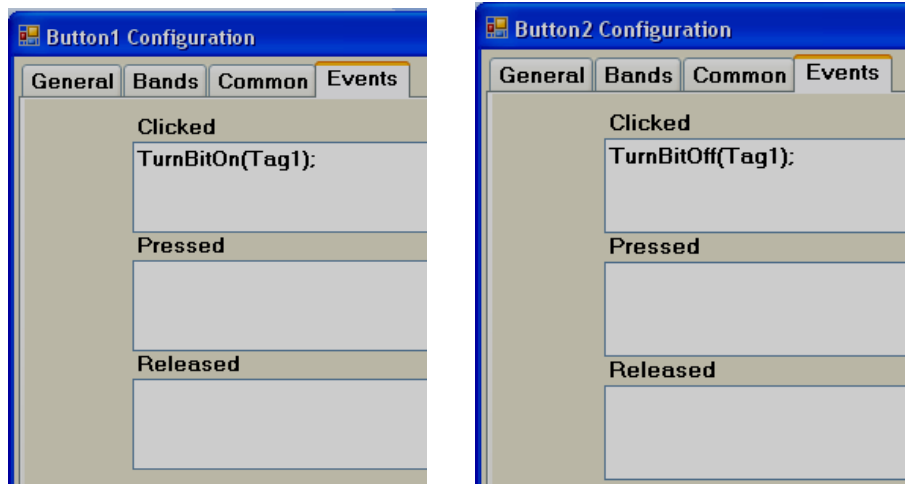

When the operator clicks Button1, Tag1 will = 1. Now, Tag1 will = 1 even after the operator releases the button, and it will continue to maintain its earlier state. When the operator clicks Button2, Tag1 will = 0.

5.3.17.16 Function editor

This is very useful to select different functions to execute based on operator actions. During Run time, this provides an easy way for an application developer to use a ready-made macro instead of writing scripts. Insert a Button into any screen and configure events. The following functions are supported.

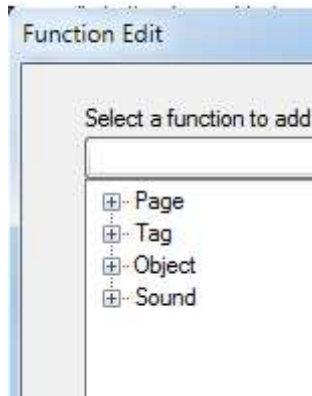

Page Control functions

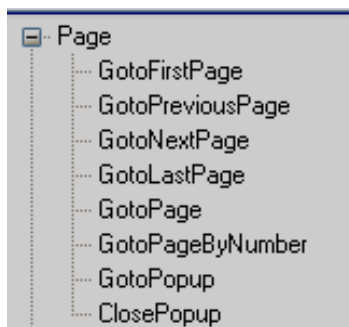

Every screen has a screen number. The pointer will be the screen number for navigation.

GotoFirstPage: It is used to navigate from current screen to first screen

GotoPreviousPage: Used to navigate from current screen to previous screen

GotoNextPage: Used to navigate from current screen to next screen

GotoLastPage: Used to navigate from current screen to Last screen

GotoPage: Used to navigate from current screen to specific screen by name

GotoPageByNumber: Used to navigate from current screen to specific page by number

GotoPopUp: Used to open specific pop up screens by name

ClosePopUp: Used to close pop up screens by name

Tag functions

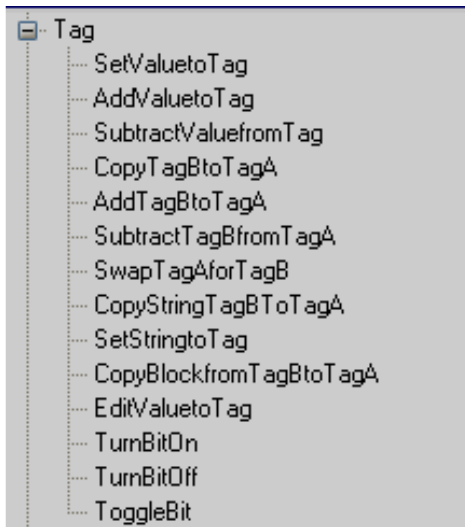

SetValueetoTag: Writes a value to a tag

Example: Set 90 to TagA when operator presses on a button during run time.

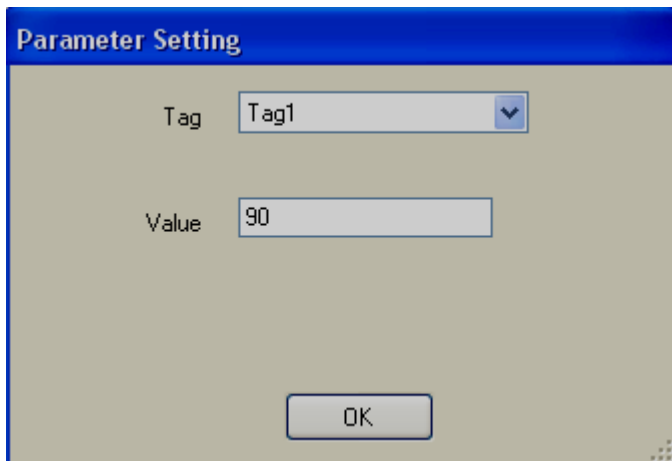

AddValueetoTag: Used to add value to Tag

SubtractValuefromTag: Used to subtract value from Tag

CopyTagBtoTagA: Used to copy TagB value to TagA

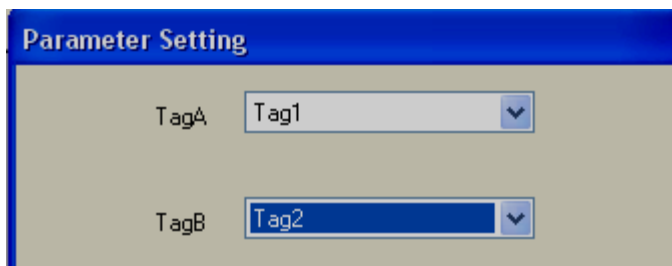

AddTagBtoTagA: Used to add TagB to TagA and store result in TagA

SubtractTagBfromTagA: Used to subtract TagB from TagA and store the result in TagA.

SwapTagAforTagB: Used to swap TagB data with TagA

CopyStringTagBtoTagA: Used to copy the string type of TagB to TagA

SetStringtoTag: Used to write a string to a String type Tag

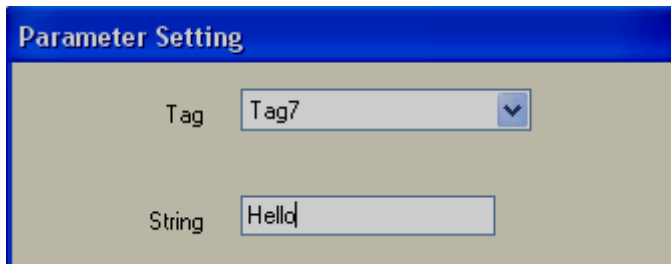

CopyBlockfromTagBtoTagA: Used to copy a block of tags from TagB to Tag1

For example: Copy 4 continuous tags from Tag5 to a target location starting with Tag1. Tag5 is copied to Tag1, Tag6 is copied to Tag2, and so on.

Note: Maximum block size is limited to 80 tags

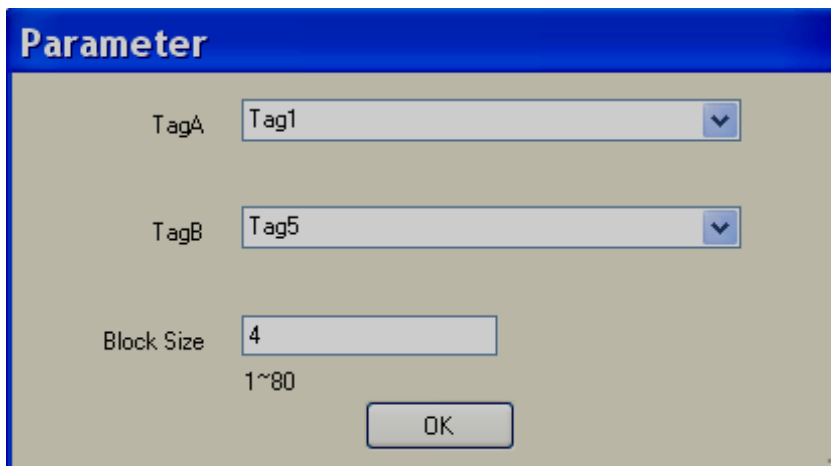

EditValuetoTag: Used to edit tag value during run time from a keypad. For example, if this function is called from button “clicked” event, then, a keypad will open during run time and the user can enter a set point.

TurnBitOn: Used to turn on a bit.

If a momentary Turn on is required, then in “Clicked” action, select Turn On, then, in “Released” action, select “Turn OFF”.

TurnBitOFF: Used to turn off a bit

Togglebit: Used to toggle the bit

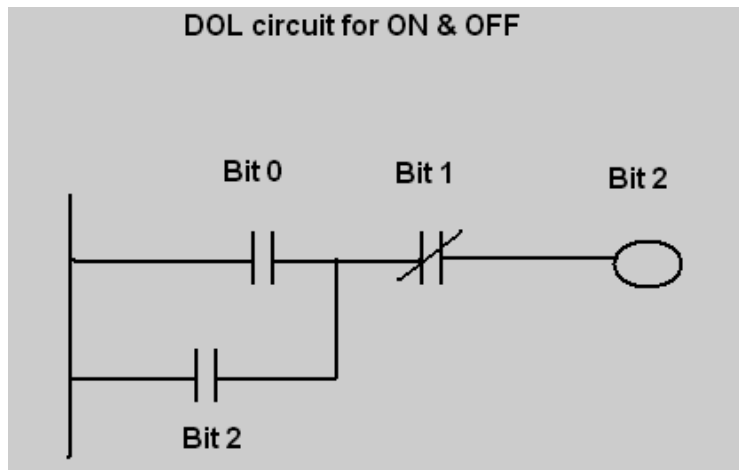
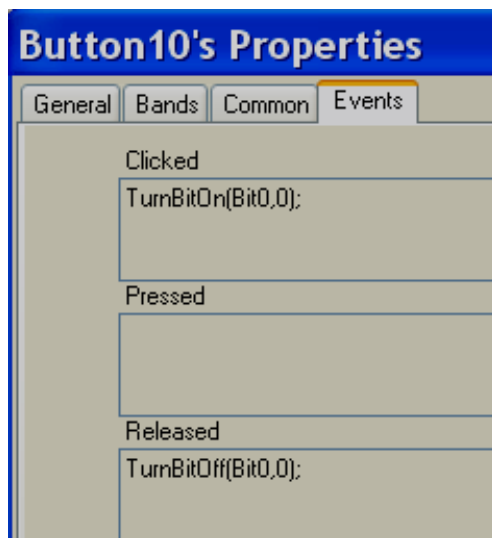

Fig: Ladder logic in PLC



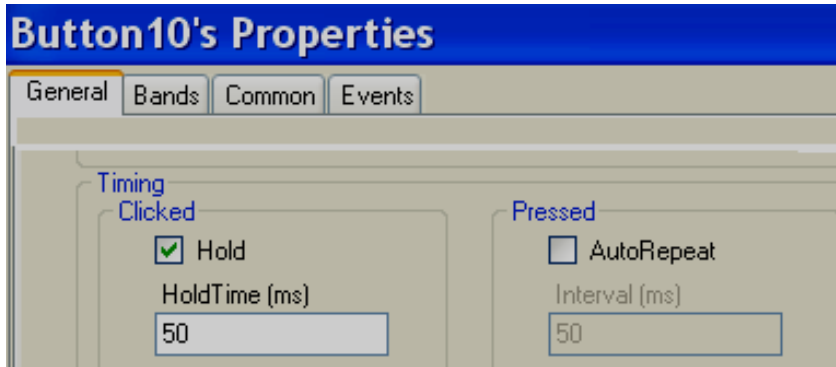

Fig: On button configuration



If a button is not switching properly at the PLC, then, in the “General” Tab, select the “Hold” check box and enter the hold time. Default value is 50 msec. If required, adjust this to 100 msec. and check again if the button is switching properly.

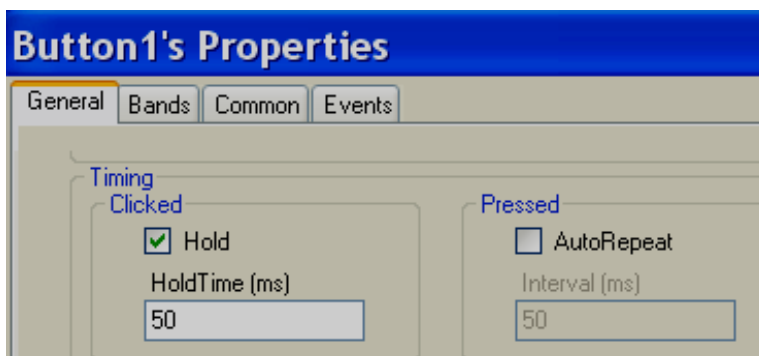
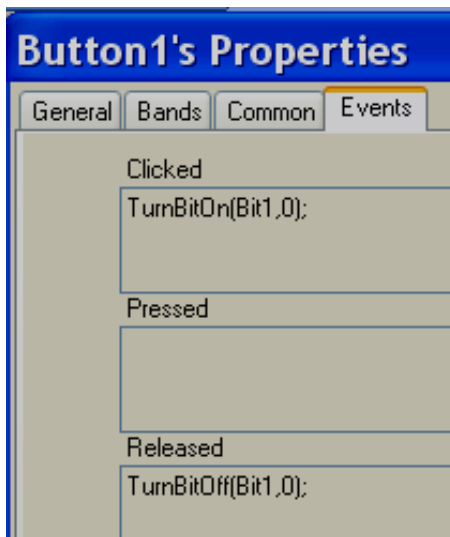
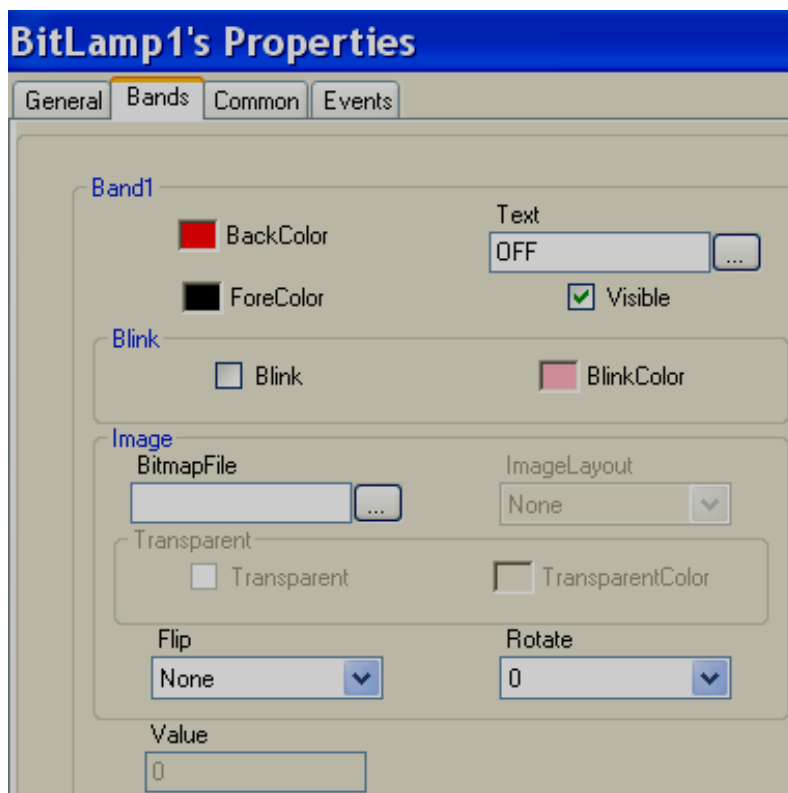
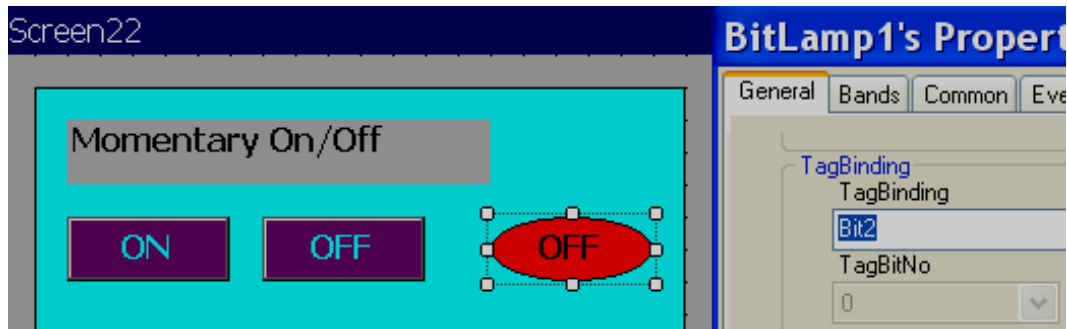

Fig: Off Button configuration



If button is not switching properly at PLC, then, in General Tab, select “Hold” check box and enter the hold time. Default value is 50 msec. If required, adjust this to 100 msec. and check again.



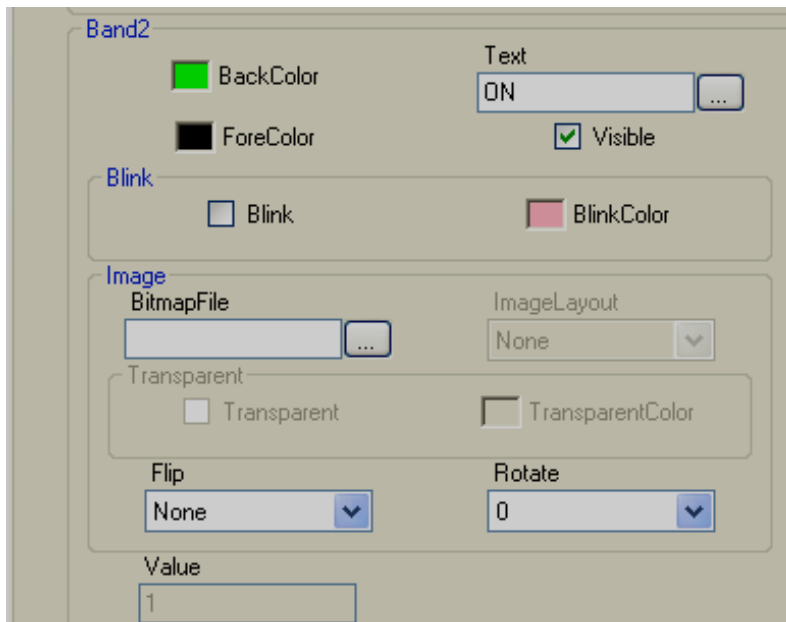

Fig: Bit lamp status

5.3.17.17 Bit lamp

A bit lamp is used to show the digital input status for the operator. It is linked with either a digital input tag or an Analog input tag. By using the band editor, it is possible to display a different foreground color, different background color, different text, different symbols, different Blink color, and control visibility when the Tag value is 0 or 1.

When a Bit lamp is linked with a digital tag, it has only two bands by default. The Band1 value is 0 and Band 2 value is 1.

For example: If Tag1 = 0, show Red colored background with an Orchid color blink. If Tag9=1, show green colored background.



GUI Wizard

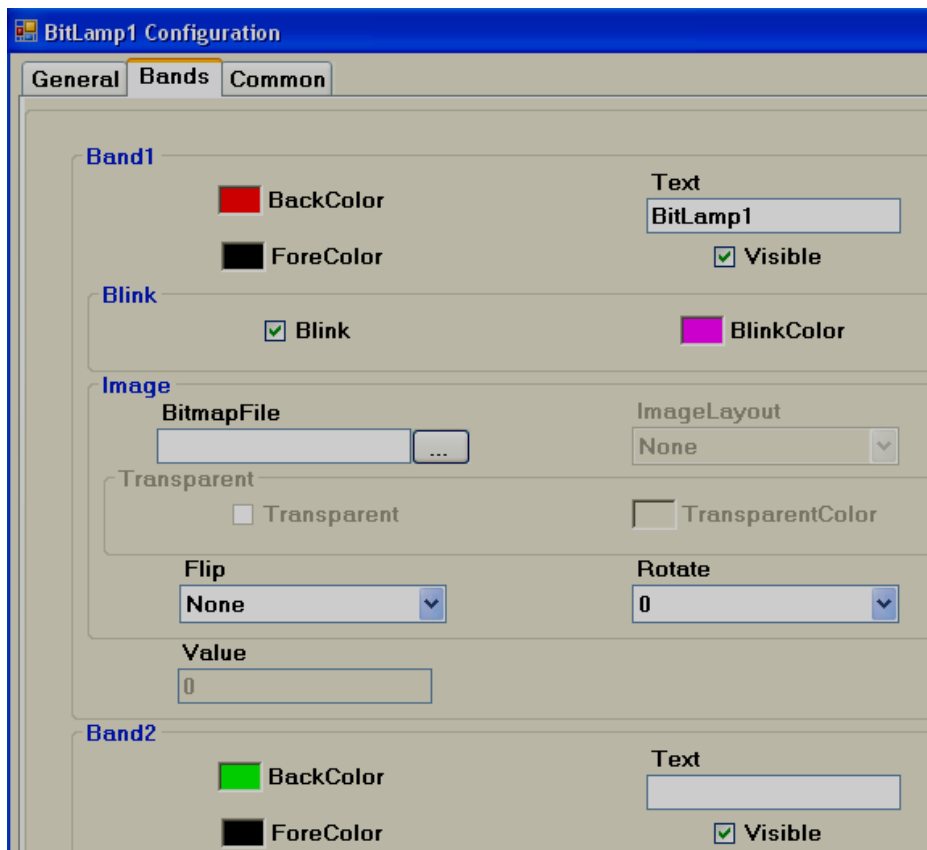
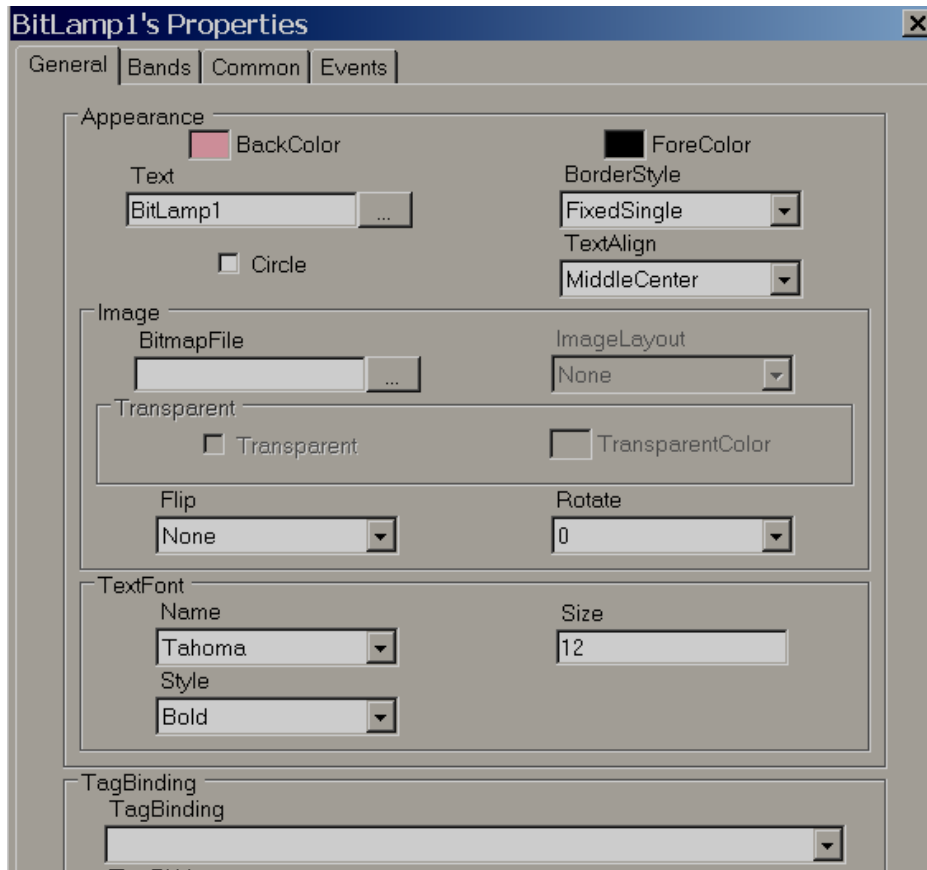

Bitmap file: Select the image to be displayed when tag value reaches this band in run time.

For example: When Tag1=0, show Red colored motor symbol
When Tag1=1, show Green colored motor symbol

Note: Two different symbols are required for the above

Bmp, wmf, jpg, gif and png types are supported. If the selected file is other than wmf, then it is also possible to select Image layout and transparent options.

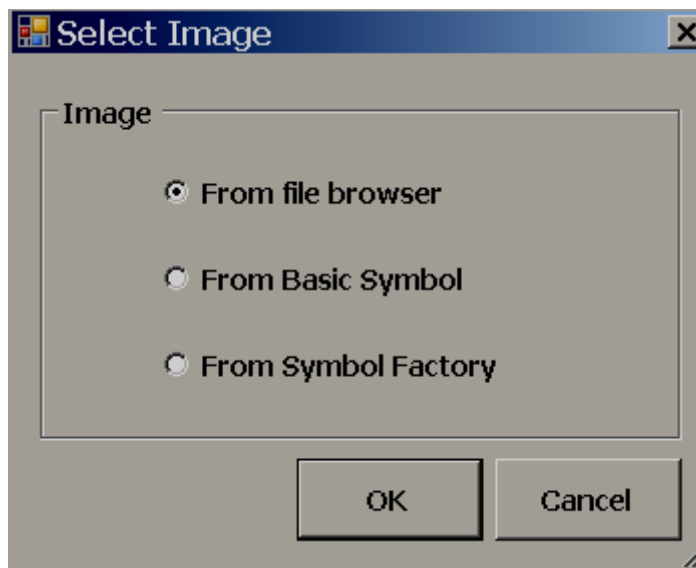

From File browser: Allows user to select images in formats of bmp, wmf, jpg, gif and png

From Basic Symbol: Allows user to select wmf format images from basic symbols

From symbol factory: Allows for selecting symbols from symbol factory in .wmf format

Image layout: None, center and Stretch options are available. Stretch means the selected bitmap will be fixed to the size of the bit lamp

Note: If a bitmap has poor resolution, when stretch is used, it may show a low quality image in screen.

Flip: Used to flip bit lamp and needs to be configured during design time. Available options include None, Horizontal, Vertical and Both.

Rotation: Used to rotate a bit lamp in predefined angles and needs to be configured at design time. Available options include 0°, 90°, 180° and 270°

Circle: By default, a bit lamp object shape is in Rectangle. Select this if you wish to change the bitlamp shape to a circle. It is more useful to show status of digital inputs for the operator during Run time.

How to show status of an individual bit in Analog type tag

Sometimes, you will get a 16 bit/32 bit tag from a PLC with different diagnostic information, and you would like to show 16 bit/32 bit lamps in the Recorder screen.

When a Bit lamp is linked with an Analog tag, for example: Int16/Int32, it has two bands. By default, Band1 value is 0 and Band 2 value is 1. In this case, using each bit lamp, it is possible to show the status of each individual bit status within 32 bits as per configuration available at band editor.

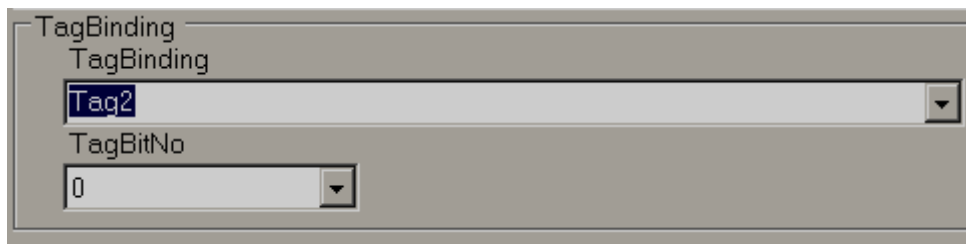

In the above figure, Tag2 is an analog type (4 byte), so, a TagBitNo combo box will appear for the selection of the required bit within 32 bits (0 to 31).

If Tag2 is Digital type tag, then, TagBitNo. Combo box is not visible.

5.3.17.18 Word lamp



Word lamps are similar to Bit lamps but linked with an Analog type tag only. It can have many bands. By using the band editor, it is possible to display a different foreground color, different background color, different text, different symbols, different Blink color, and control visibility when Tag values change values during Run Time.

For example: Tank Level indicator

When Tag1 value is

- 0 to 10, Text = Low Low Level, Color = Yellow Blinking
- 11 to 20, Text = Low Level, Color = Yellow Background
- 21 to 80, Text = Normal, Color = Green back ground
- 81 to 90, Text = High level, Color = Red back ground
- 91 to 100, Text = High High Level, Color = Red blinking

Create 5 bands as shown

GUI Wizard/Dialog

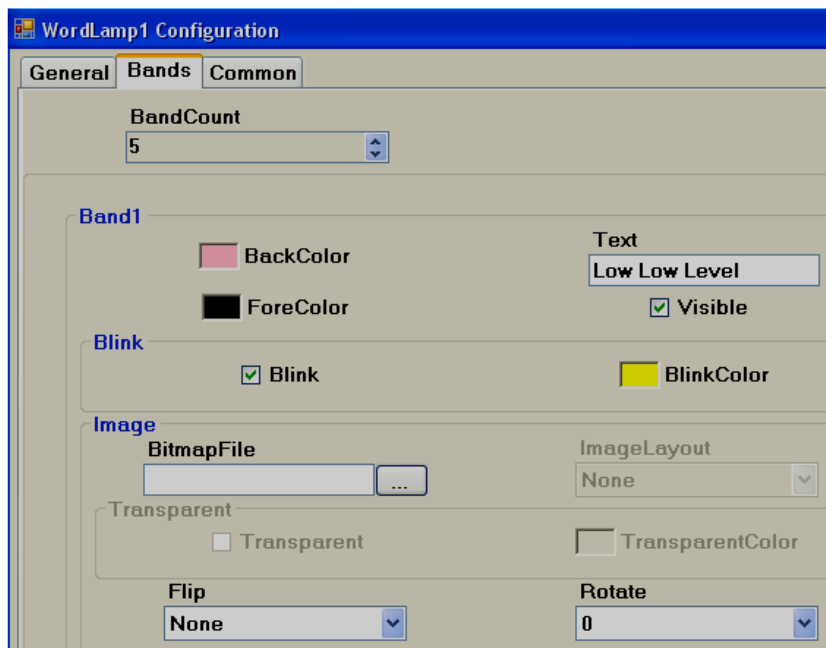
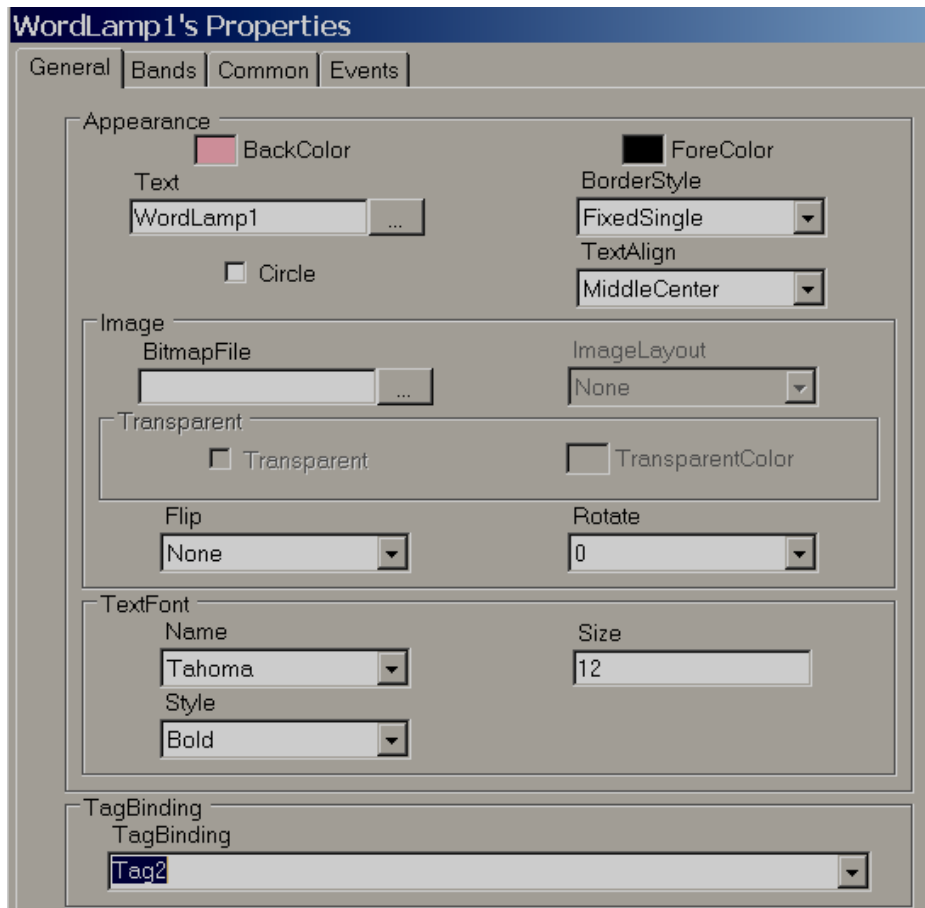

Band1 range = 0 to value defined at band2-1.
i.e., 0 to 10

Band2

BackColor
 ForeColor

Text:
 Visible

Blink

Blink

Image

BitmapFile: ...
 ImageLayout:

Transparent

Flip:
 Rotate:

Value:

Band2 range: Band 2 value to Band3 value-1
 i.e., 11 to 20

Band3

BackColor
 ForeColor

Text:
 Visible

Blink

Blink

Image

BitmapFile: ...
 ImageLayout:

Transparent

Flip:
 Rotate:

Value:

Band3 range: Band 3 value to Band4 value-1
 i.e., 21 to 80

Band4 range: Band 4 value to Band5 value-1
i.e., 81 to 90

Band5 range: More than or equal to value defined at band 5 (In this case number of bands=5)
i.e., greater than 91

5.3.17.19 Check Box

The Check box (or tick box) is a graphical user interface widget that permits the user to make multiple selections from a number of options during run time. Generally it is linked with a Digital type tag Flag/Bit memory in a PLC for use in ladder programming to receive an action from an operator.

CheckBox

Every check box is linked with a single **Digital** tag from Tag Database

In the above white box, normally,

white space means Not selected, False, Tag Value = 0

Tick mark means, True, Tag value = 1

A caption describing the meaning of the check box is normally shown adjacent to the check box. Inverting the state of a check box is done by touching with a finger or clicking the mouse on the box, or on the caption.

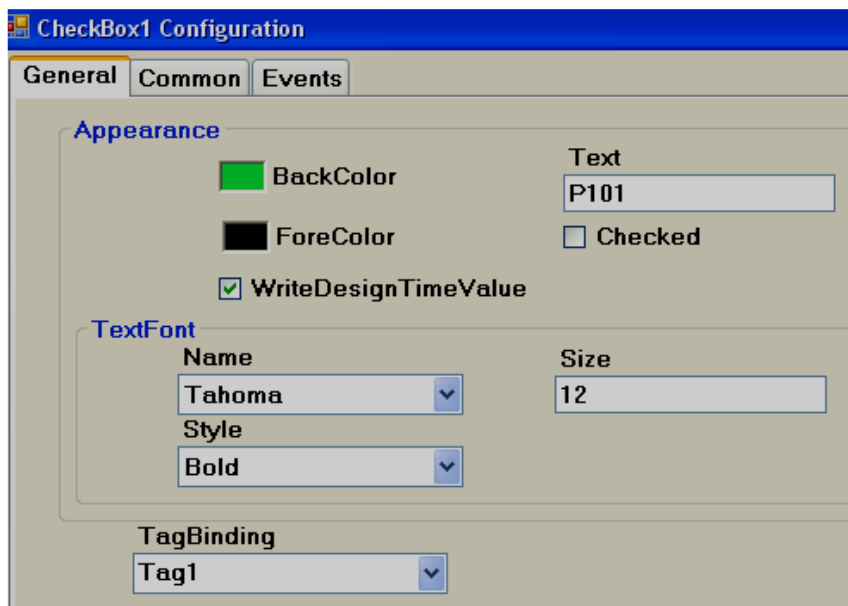
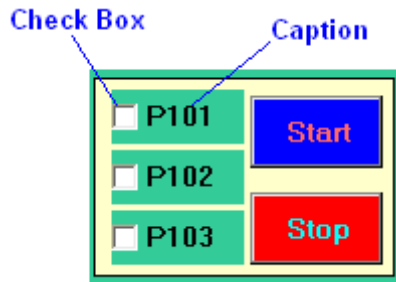

Properties

Write design time value: If selected, it overwrites the default value defined in the tag database.

Checked: Default setting, available options True/False

For example: Tag1 is linked with Checkbox 1. If Checked, the tag = False, that means Tag1=0. If Checked, the tag = True, then Tag1 = 1.

Text: It is Text that appears near Check box as a caption. Example: Text = P101

Events

Changed: Define action using function editor. When operator presses on check box during Run time, the actions defined here will be executed.

Example: There are three pumps named P101, P102 and P103, and the operator would like to select pump P101 for startup. Using the check box, write a meaningful caption via the "TEXT" property to appear at the right side of check box, and link each of the above check boxes with appropriate Tags. Let's say P101, P102 and P103.

Then, when P101 is selected by the operator in run time, P101 Tag value will become 1.



If "checked" = false is selected during design time, then Tag value will = 0. If operator presses on check box during Run time, the symbol ✓ will appear, and **the** Tag value will become 1.

If "checked" = True is selected during design time, the Tag value will = 1, and the ✓ appears during Run time. If the operator presses the check box during design time, the symbol ✓ disappears and the Tag value becomes 0.



If you are unable to select the required selection using check box in Run time, please perform touch screen calibration.



If Check box is linked with an Analog type Tag, then, it is possible to select an individual bit.

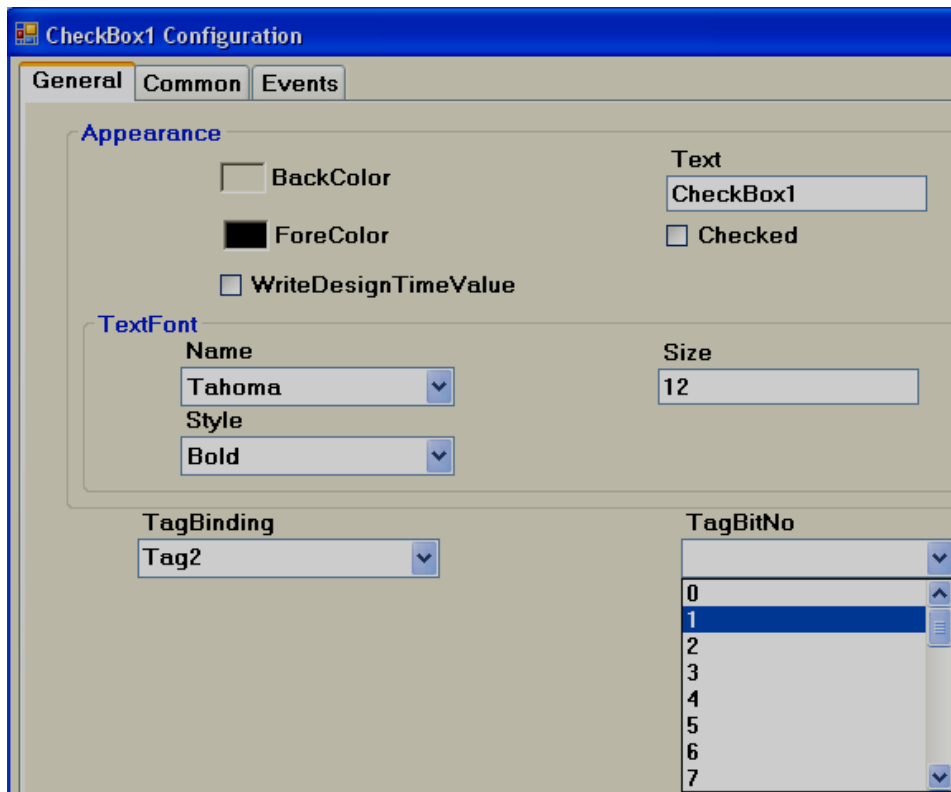

5.3.17.20 Combo box



A combo box is a commonly-used graphical user interface widget. It is a combination of a drop-down list or list box and a single-line textbox, allowing the user to choose from the list of existing options in Run time. Generally it is linked with an Analog tag. Based on selection, the value of the tag will be changed, and it can be used in Logic at PLC.

It saves space in the Recorder screen by allowing the operator to select the option only when it is required by touching the down arrow at right side of Combo box.

Every Combo box is linked with single **Analog** tag from properties.

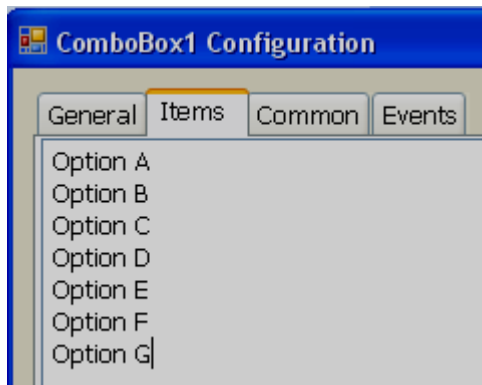
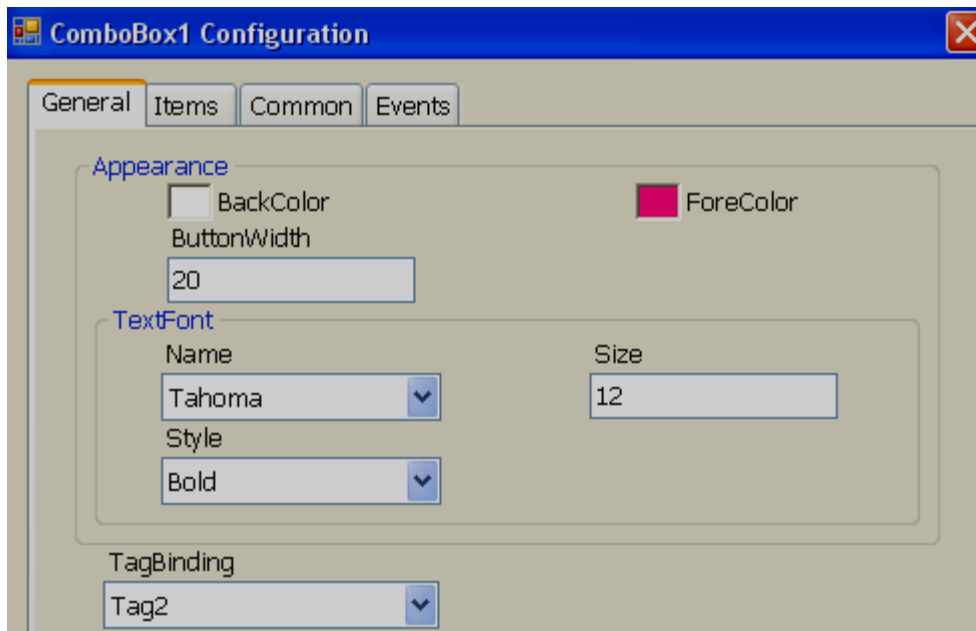

Note: Do not keep any empty space between different text entries, otherwise, unpredictable results may occur.

Property grid

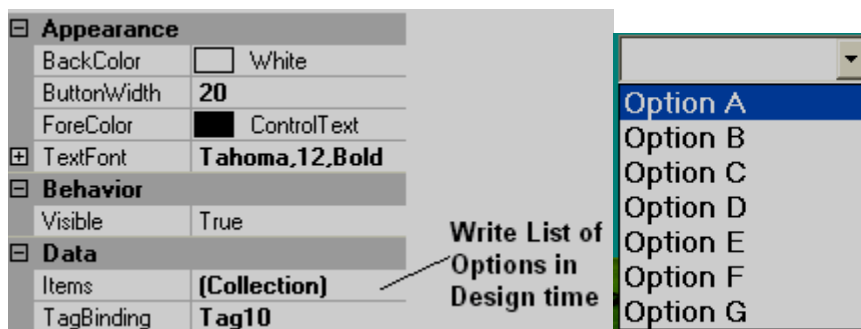

Design	
(Name)	ComboBox1
Locked	False
SecurityLevel	0
Events	
Changed	
Layout	
Dock	None
Location	128, 96
Size	224, 24

Properties

Button Width: Defines the width of a Button. It modifies the width of the down arrow at the right side of the combo button.

Items: Defines all the available options during design time.

For example: There are 7 options available to select a process.

Tag1, an analog tag, is linked to Combo box1

Now, If Option A is selected, then during Run time, Tag1 value will = 0,

If Option B is selected, then Tag1 value will = 1

.....

.....

If Option G is selected, then Tag1 value will = 6

Events

Changed: Defines an action using function editor. When the operator presses on a combo box during Run time, the actions defined here will be executed.



To increase up/down arrow size on combo box, increase the size of text font.

5.3.17.21 List box



A list box is a Graphical User Interface widget that allows the user to select a single item from a list of available items. The available options are entered during Design time and they are available for selection during Run Time. On selection, it writes a value to a Tag based on the order number.

Every List Box should be linked with an **Analog** tag.

GUI Wizard/dialog

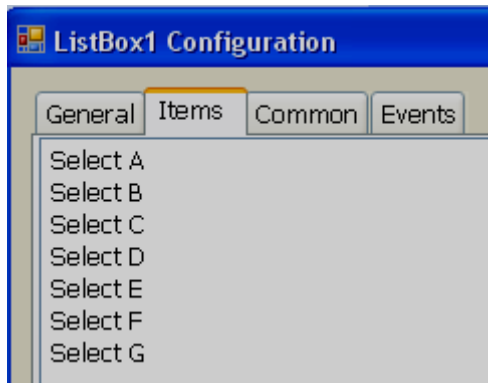
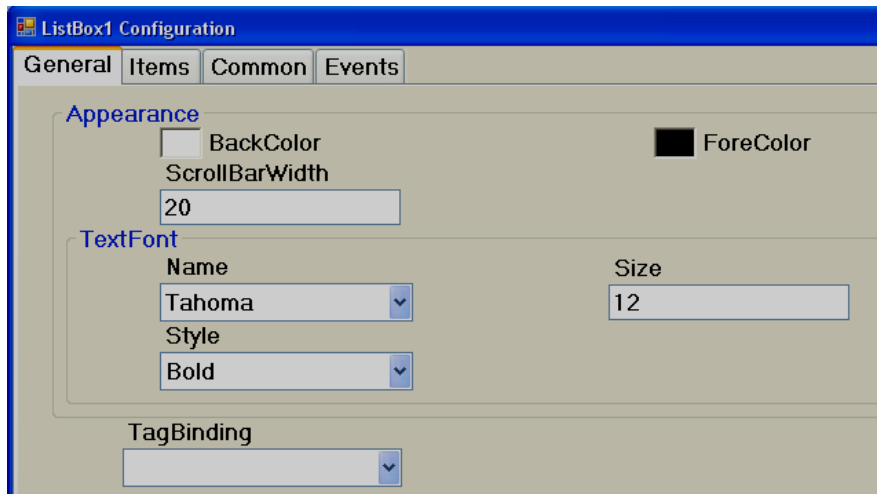

Note: Do not keep any empty space between different text entries, otherwise, unpredictable results may occur.

Property Grid

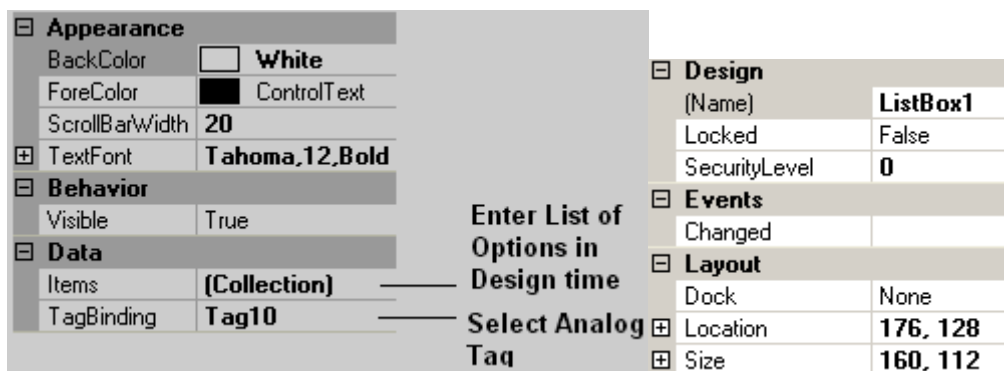

Properties

Scroll Bar Width: Defines the width of the scroll bar that appears on Right side of List box.

Items: Define all the available options in design time.

For example: There are 6 options available to select a process.

Tag1, an analog tag, is linked to List box1

Now, If “Select A” is selected, then Tag1 value will = 0

If “Select B” is selected, then Tag1 value will = 1

.....

.....

If “Option G” is selected, then Tag1 value will = 5

Events

Changed: Define actions using function editor. When operator presses on list box item in Run time, the actions defined here will be executed.

5.3.17.22 Group Panel

Used to group objects in a screen.

Procedure

Click on “Group Panel” at Basic Objects

On Screen, just draw a rectangle with your mouse over the objects that you would like to group together. It will appear as shown below:

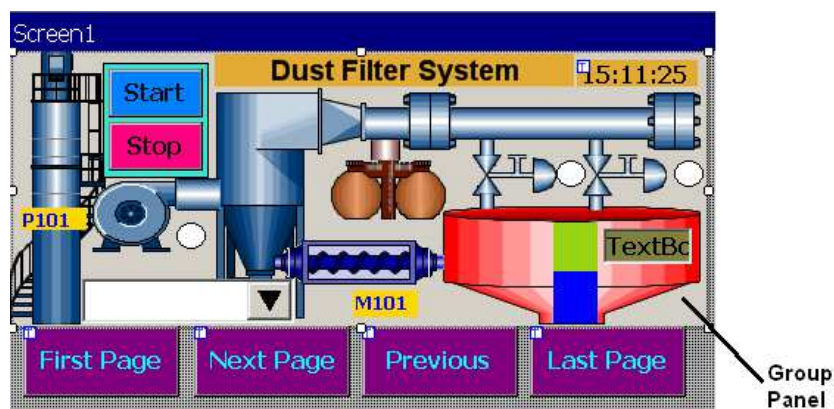

Now, double click on Group Panel object

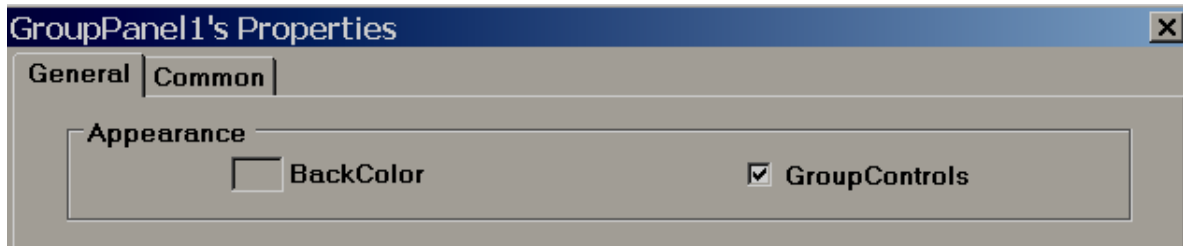

Select "Group Controls" check box and click "OK"

Now, you will be able to move grouped objects to another location, or rescale them to fit to another screen size etc.

Group Controls: Select the check box to apply the group function. De-select the check box for ungroup

5.3.18 Enhanced Objects

Fine components are available for User interface and display. The components include Dial, Digital LED, Level, Meter, Slider, Switch, Thermometer and Toggle.

5.3.18.1 Common Properties

Appearance

Back Color: Set the background color of the component.

Bevel: Used to set border including inner border, outer border and style of border.

Inner Border: True/False

Outer Border: True/False

Style: 9 styles are available

None, Flat, Single, Double, Raised, Lowered, Double Raised, Double lowered, Frame Raised, Frame Lowered.

Behavior

Visible: True/False. Determines whether control is visible or hidden.

Enable: This is for event control. If linked with a Digital tag, if the tag value =1 during run time, events configured for the object will be executed. If tag value = 0, events will be not executed

Data

Tag Binding: Select the Analog Tag of process value

Write design time value: If selected, the value entered here during design time will be replaced by the default value defined in the tag data base.

Design

Name: Label1, It is the name of the component. Every component will have a **UNIQUE** number in a page. If more than one Label is available in the same page, the number will be incremented automatically. The user can also change name of this component if required.

Component "Name" property is very useful and it can be used in scripts also.

Example: Task: Change Label1 "back" color to blue during Run time when Tag1 is equal to 1.

```
if(Tag1 == 1)
{
  Screen1.Label1.BackColor=Color.Blue;
}
```

Screen1: It is the location of Label1

Label1: Object name

BackColor: Property of Label related to background color

Color.Blue: Target Color

If the above script is executed in scheduler once per second, then when Tag1 = 1, the back color for Label1 will change to Blue during Run time.



Properties are case sensitive.

BackColor : OK

Backcolor : Not OK

Security Level: Define security level for the component to be used by the operator. If operator security level is less than security level defined for component, it will not allow operator to operate the component.

Locked: True/False: It is to Move or Resize the component.

Layout

Dock: Defines which borders of the control are bound to the container.

Location: The coordinates of the upper-left corner of the component relative to upper-left corner of the container. Set X and Y position in screen in pixels.

Size: Size of the component in pixel. Set height and width of component in pixels.

Position: It is the defined position of Label, Value etc, for some components. Available options include None, Top Left, Bottom Right, Both and Internal.



Position naming convention for components

For example: Level component, Label Position = **Bottom Right**

If Orientation is Vertical, the Label will be displayed on the **Right** side of the component.

If Orientation is Horizontal, the Label will be displayed on the **Bottom** side of the component.

5.3.18.2 Level

Levels are normally used to display a process parameter value in several steps. Generally it is linked with Analog type tag (Analog input type tag at PLC, which is received as 4-20 mA signal from field transmitters like Ear level transmitters (sound detectors in ball mills, etc)).

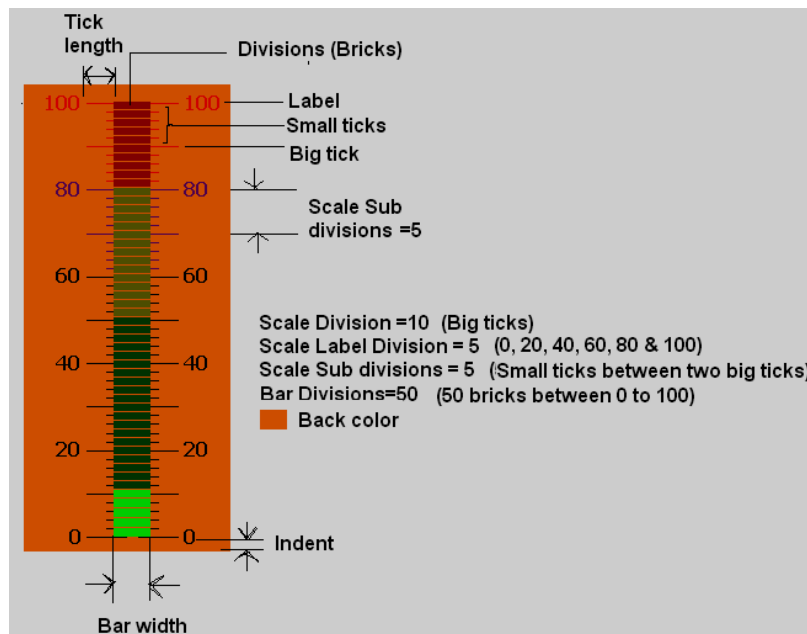

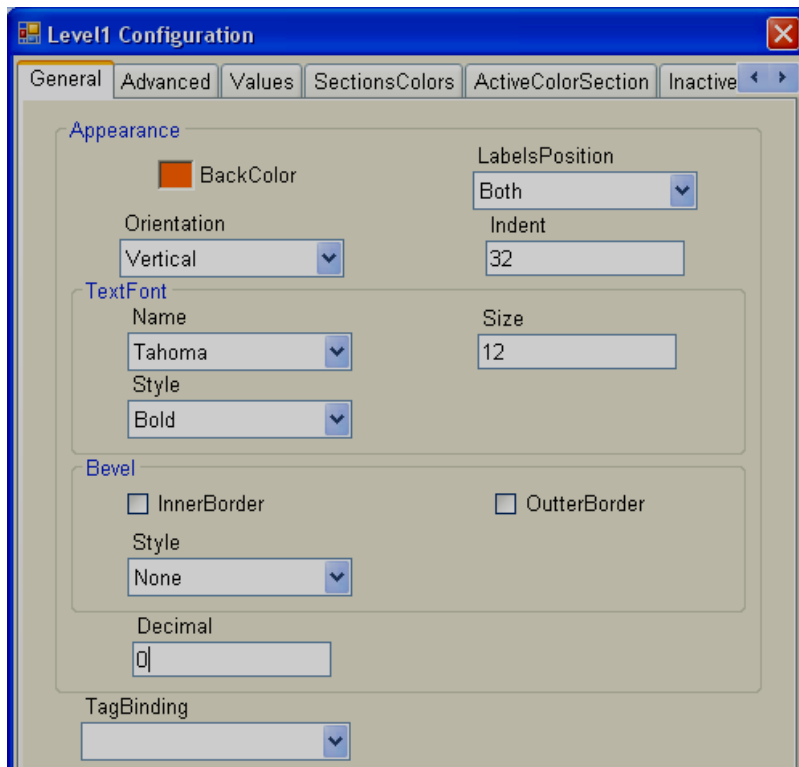

Properties

Back Color: Defines the background color for the component.

Labels Position: Define label position. Available options are Top Left, Bottom Right and Both. Naming convention depends on orientation. If orientation = Vertical, then, if “Top left” is selected, label position will be shown on “Left” side. If orientation = Horizontal, then if “Top Left” is selected, label position will be shown on “Top” side of component.

Orientation: Vertical/Horizontal. Select direction.

Text Font: Used to set the font of the label. Options include Name of Font, Size of font and Style of font. Supported styles include Regular, Bold, Italic, Underline & Strikeout.

Bevel: Defines inner border and outer border for the component. Please refer to common properties at the beginning of this section for more details.

Decimals: Define number of decimals to be displayed for value to be displayed along with level component in run time.

Tag Binding: Selects the Analog Tag of process value.

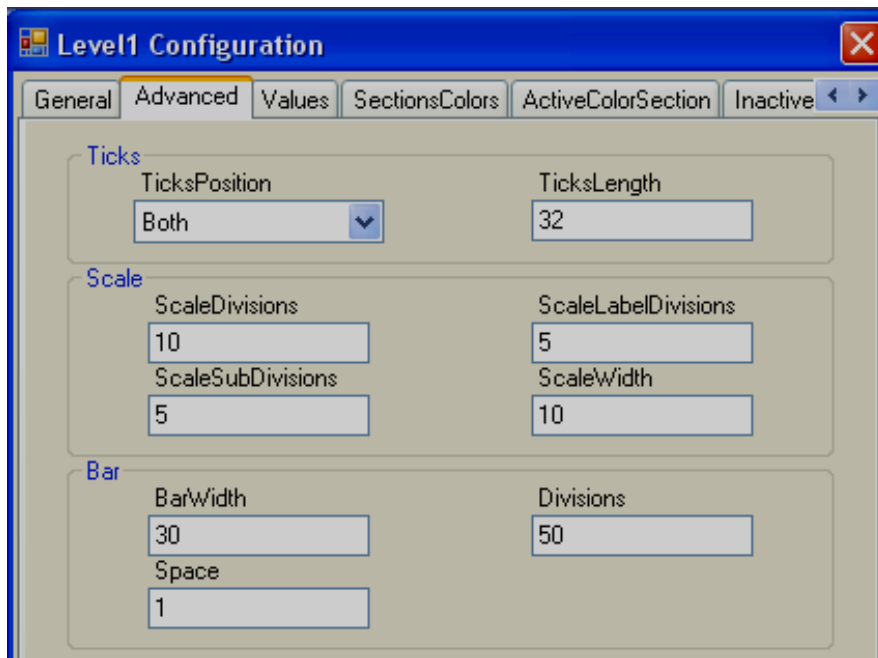

Ticks:

Ticks Position: Define Ticks Position. Available options include Top Left, Bottom Right, Both and None.

Ticks length: Define length of Ticks in pixels.

Scale:

Scale divisions: Define the number of Big Ticks in Level graph.

Scale Sub Divisions: Define the number of ticks between two big ticks.

Scale Label Divisions: Define the number of Labels to be displayed.
Example: If Scale label division = 5, Scale = 0-100, then, it display labels as 0, 20, 40, 60, 80 & 100.

Scale Width: Define Scale width. If ticks are selected to display on both directions, this is the defined width between two scales on both sides.

Bar

Bar Width: Define width of Bar graph.

Divisions: Define number of divisions (Like bricks) to appear in Bar graph.

Space: Define Space between divisions (bricks) in pixels.

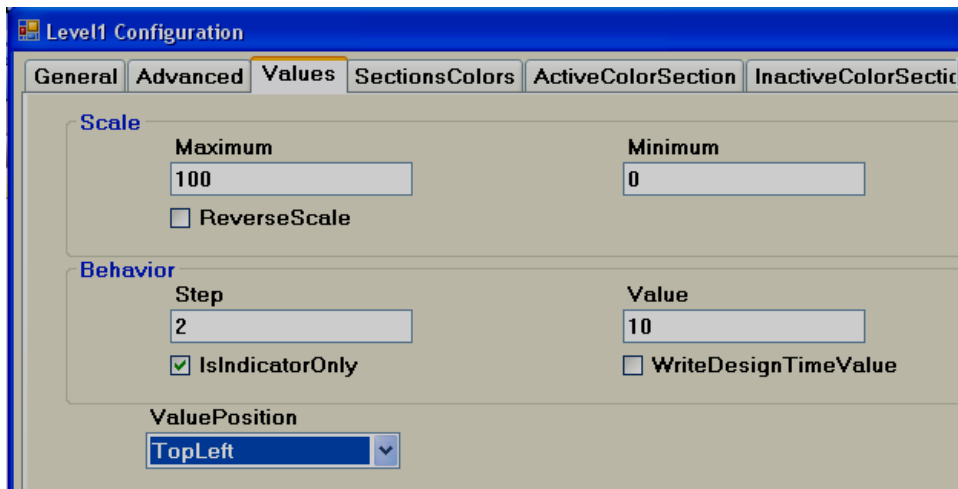

Maximum: This is the max range of the process value (analog input tag)

Minimum: This is the minimum range of Process Value (analog input tag)

Example: If an Ear Level transmitter range is 0 to 100, set Minimum = 0, Maximum = 100.

Reverse Scale: True/False. If it is selected, then, zero will be on bottom side and 100 will be at top side for vertical orientation.

Step: This is the minimum value to reflect change in Bar graph position. Bar Step and Bar division settings are closely related. If Bar divisions = 50 for a scale value of 0-100, then, if Step=2, when process value changes by value 2, it shows level value change clearly in level graph.

Value: Used to enter a process value during design time and to check the bar graph display on the PC. It requires the operator to enter a value in multiples of the step value. Otherwise, it is automatically rounded to the closest multiple of the step value.



Is Indicator only: If this is selected, the level graph is used for “Read” purposes only. If it is not selected, you can use a level graph for write purposes similar to slider to send a set point from the Recorder to a PLC etc. Just use finger to touch at various places in Level graph to set the level required.

Value Position: Define position of process value to be displayed during Run time along next to the Level graph. Available options include None, Top Left, Bottom Right and Both.

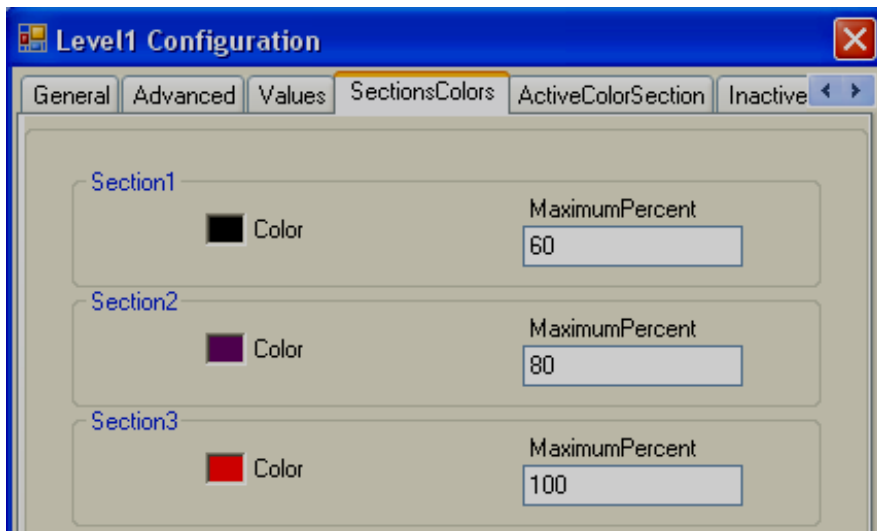

Sections colors: It is configure bands for the sections to show different colors for Labels and Ticks in Level graph.

Example: Three bands
 Section 1, Max % = 60 means, its band is from 0 to 60 %, and it will show labels and ticks in black color.

Section 2, Max % = 80 means its band is from 61 to 80 %.

Section 3, Max % = 100 means its band is from 81 to 100 %.

Note: Band setting is in % for the total Scale defined (Minimum to maximum).

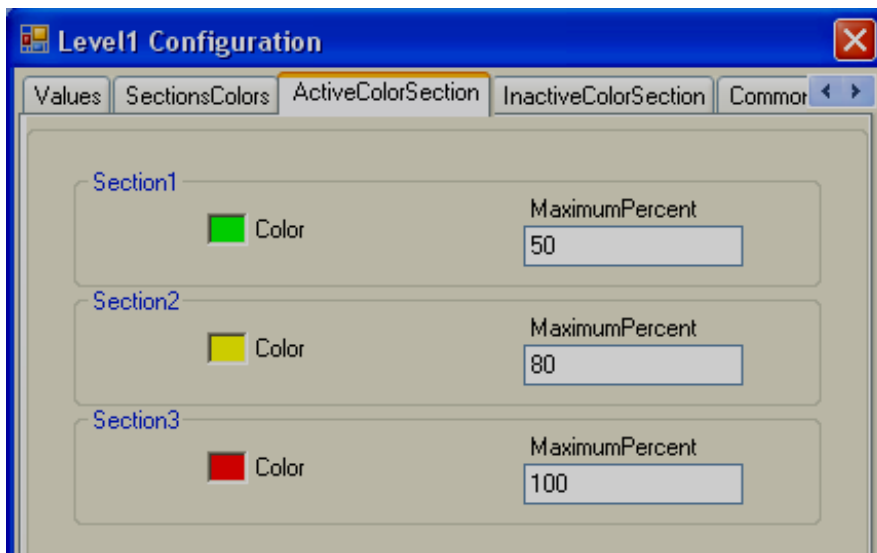

Active Color Section: Defines the active color for the process value band. For example: If a process value range is 0-100, set different bands in % for the process value, and define colors to appear within the level Bar graph during Run Time.

When the process value is between 0 and 50 % of scale, display bricks in Lime color.

When the process value is between 51 and 80 % of scale, display bricks in Yellow color

When the process value is between 81 and 100 % of scale, display bricks in Red color.

Configuration from Property grid

ActiveColorSection	ColorSection[] Array
InactiveColorSection	ColorSection[] Array

Click the “ColorSection Array and the following screen will appear. Then, set all the bands and colors.

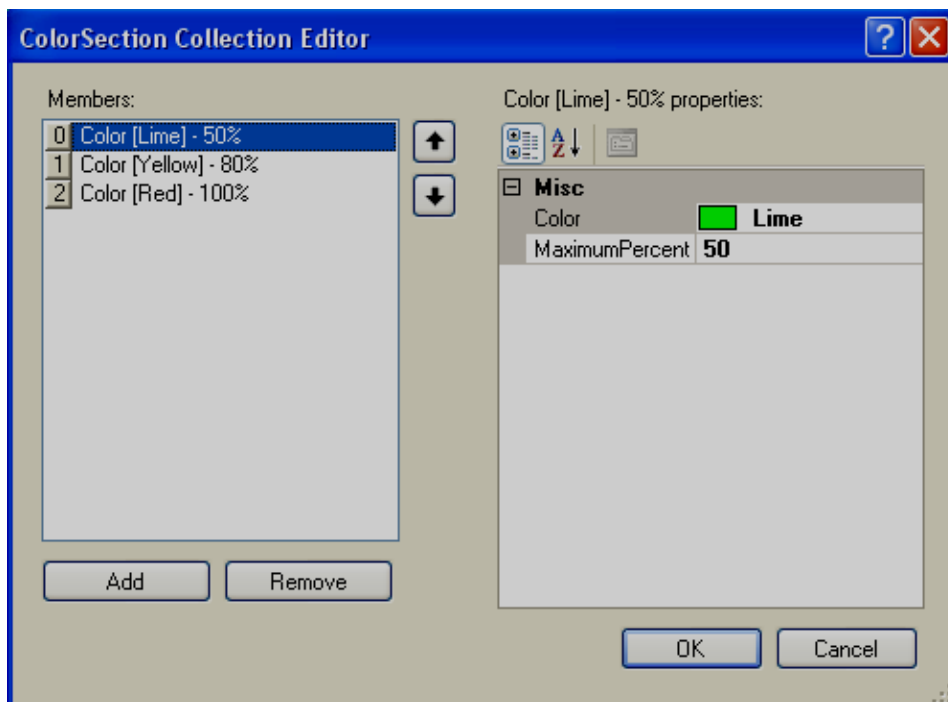

Inactive Color Section: Define Inactive colors for process value bands the same as above. Generally, light colors are selected for Inactive colors and dark colors with more contrast are selected for Active colors. This way, users/operators will be able to differentiate between active and inactive colors easily.

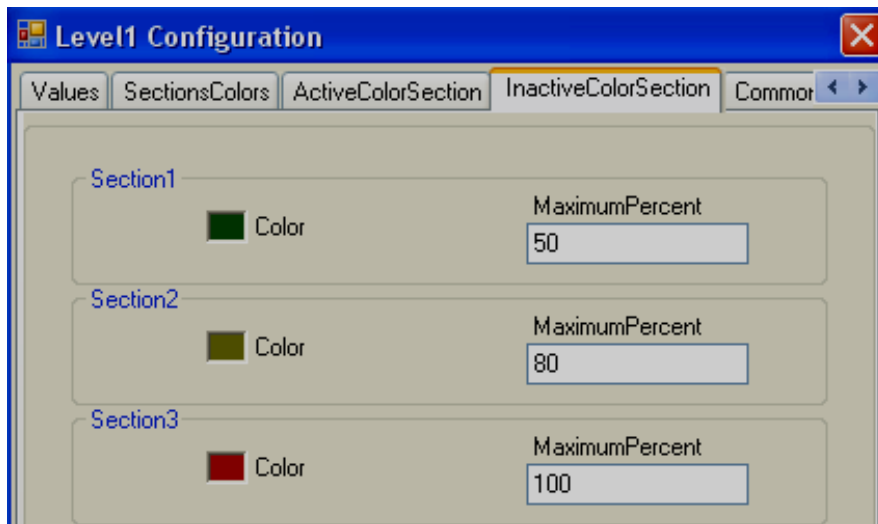

Events: It is to trigger functions/jobs to be executed when process value of tag linked with Level bar graph is changed during run time.

5.3.18.3 Meter

A Meter is a component generally used to display process values like pressure, Temperature, Flow etc. Generally, it is linked with an Analog tag (Analog input type tag at PLC, which is received as 4-20 mA signal from field transmitters like Temperature, pressure, etc...)

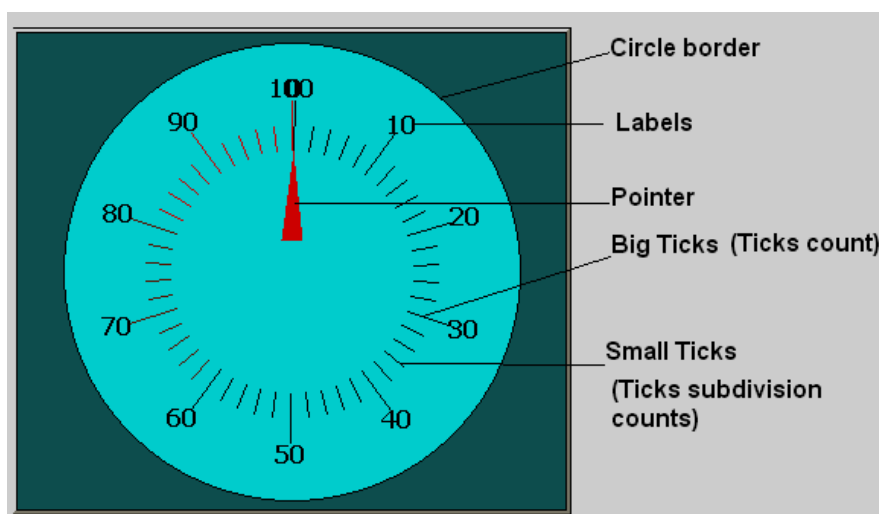

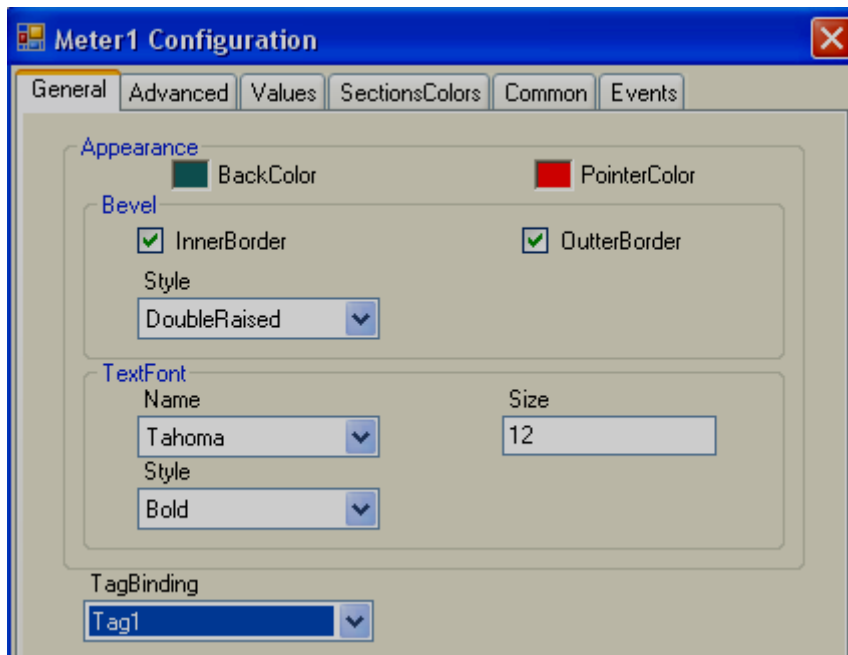

Properties

Back color: It is to set back ground color for the Meter.

Pointer Color: It is to set Pointer Color.

Bevel: It is to set border including inner border, outer border, and style of border.

Inner Border: True/False

Outer Border: True/False

Style: 9 styles are available

None, Flat, Single, Double, Raised, Lowered, Double Raised, Double lowered, Frame Raised, and Frame Lowered.

Text Font: Used to set font for the label including Name of Font, Size of font and Style of font. Supported styles include Regular, Bold, Italic, Underline & Strikeout.

Tag Binding: Select the Analog Tag of process value.

Meter2 Configuration

General | **Advanced** | Values | SectionsColors | Common | Events

Labels

LabelsCount: 10
 LabelsRadius: 120
 LabelsVisible

Pointer

ExternalPointerRadius: 80
 InternalPointerRadius: 20
 PointerSize: 7
 PointerType: Triangle

Ticks

TicksCount: 10
 TicksRadius: 50
 TicksLength: 32
 TicksSubDivisionsCount: 5
 TicksVisible

Center

Width: 0
 Height: 0

Circle

BorderCircleColor: BorderCircleColor
 CircleRadius: 150
 CircleColor: CircleColor

Labels:

LabelsCount: Number of labels to be displayed around the Meter.

Example: Pressure transmitter range 0-100 bar
 Label count =10 Around the Meter, you will see labels marked with 10, 20, 30, 40, 50, 60, 70, 80, 90 and 100.

LabelsRadius: It is to set the radius of Labels to be displayed around the Meter.

LabelsVisible: True/False, it is to set visibility for the label



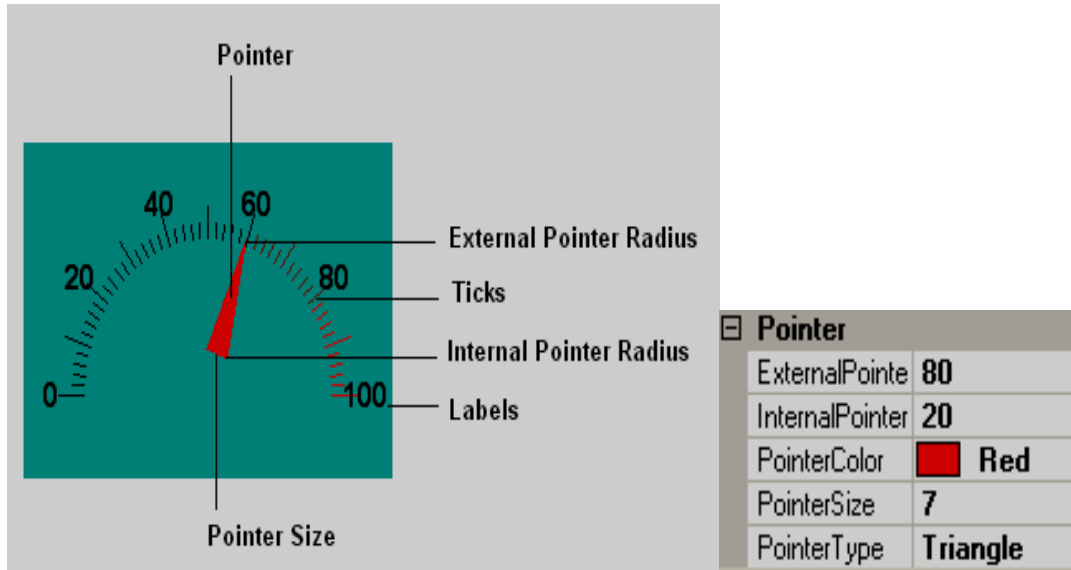

External Pointer Radius: It is used to set external pointer Radius, define end position.

Internal pointer Radius: It is used to set Internal Pointer Radius, defines start position.

Pointer Size: It is to set Pointer Size in pixels.

Pointer Type: It is set Pointer type. Available types include Triangle, Circle and Line.

Ticks

Ticks Count: Set number of ticks between labels.

Ticks Length: Set Tick length in pixels.

Ticks Radius: Set Tick Radius

Ticks subdivision counts: Set Tick sub division counts

Ticks Visible: True/False, Set Ticks visibility

Center

Width: Adjust width of meter within boundaries.

Height: Adjust height of meter within boundaries. This is useful when a half-circle meter is required. The meter needs to be adjusted to the center as shown below.

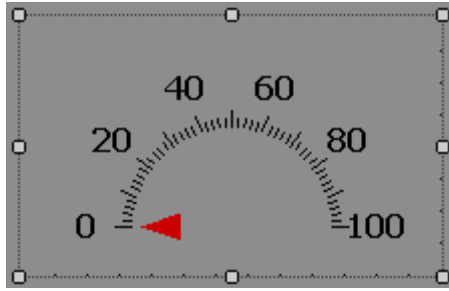

Circles

Border circle Color: Set border color for circle.

Circle Color: Set Color for circle.

Circle Radius: Set Radius for circle.



Note: If Border circle color is the same as the back color, then the circle will not be visible.

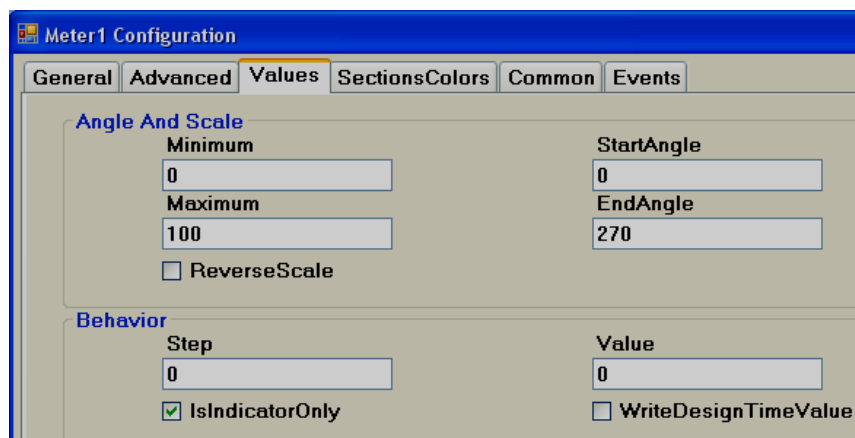
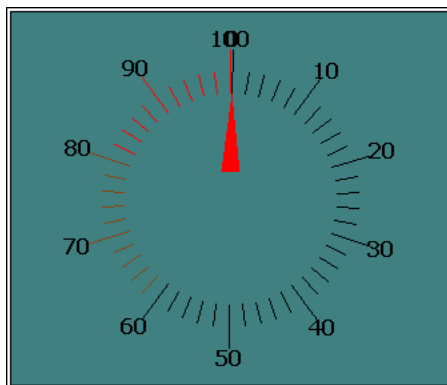

Angles & Scale

Maximum: This is the maximum range of the Process Value (an Analog input Type Tag).

Minimum: This is minimum range of Process Value (Analog input Type Tag).

Example: If pressure transmitter range is 0 to 100 bar, set Minimum = 0, Maximum = 100.

Start Angle: It is the start angle for the Range low (Analog input)

End Angle: It is the end angle for the Range high (Analog input)

Reverse Scale: It is to set scale direction in Meter

False: Anti-Clockwise

True: Clockwise

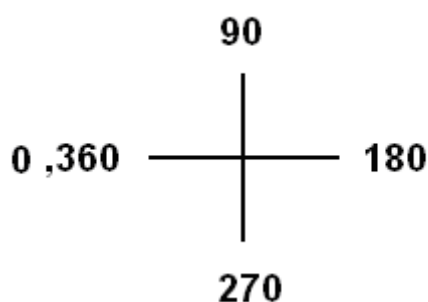

Fig: Standard Reference angle

Reverse Scale = True

For example: If you want 0° (Left) to 180° (Right) Meter for Process value range 0-100, set the following.

Start Angle: 0° , End Angle: 180° and Reverse Scale = True.

Behavior

Step: It is the minimum value to reflect change of pointer position in Meter.

For example: By default, Step = 0, i.e., the pointer moves its position in the Meter in Real time even with a minor change in process value.

For example: Step = 5, i.e., the pointer moves its position on the Meter in Real time in steps of 5.

Value: It is used to enter process value in design time and check pointer position in PC.



Indicator only: By default, it should be selected so that the meter will be used for Read purposes only. If it is not selected, then you can use the Meter for Write purpose similar to a Slider to send a set point from the Recorder to a PLC etc. Just use your finger and move pointer to change set point.

Write design time value: If selected, it writes design time value instead of default value defined at tag data base.

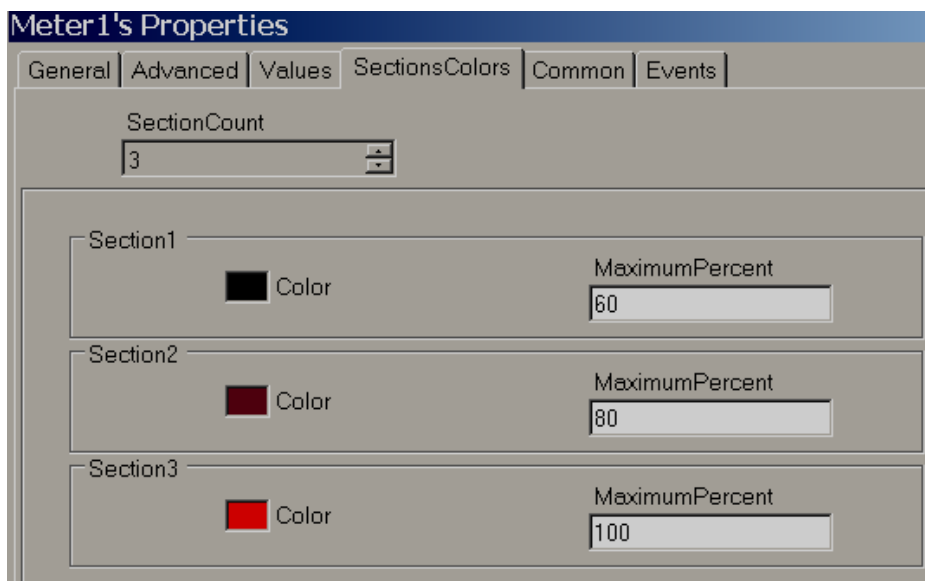

Sections colors:

It is to configure bands for the sections to show different colors for Labels and Ticks in Meter.

Example: Three bands

Section 1, Max % = 60. That means its band is from 0 to 60%. It shows labels and ticks in black color.

Section 2, Max% =80 that means, its band is from 61 to 80 %.

Section 3, Max % = 100 that means, its band is from 81 to 100 %.

Note: Band setting is in % for the total Scale defined (Minimum to maximum).

5.3.18.4 Slider

This is normally used to change the set point of a process by the operator from the Recorder during Run time. Generally, it is linked with an analog tag (analog output type tag at PLC, to send 4-20 mA signal out from PLC to external Controllers, Variable speed drives, etc).

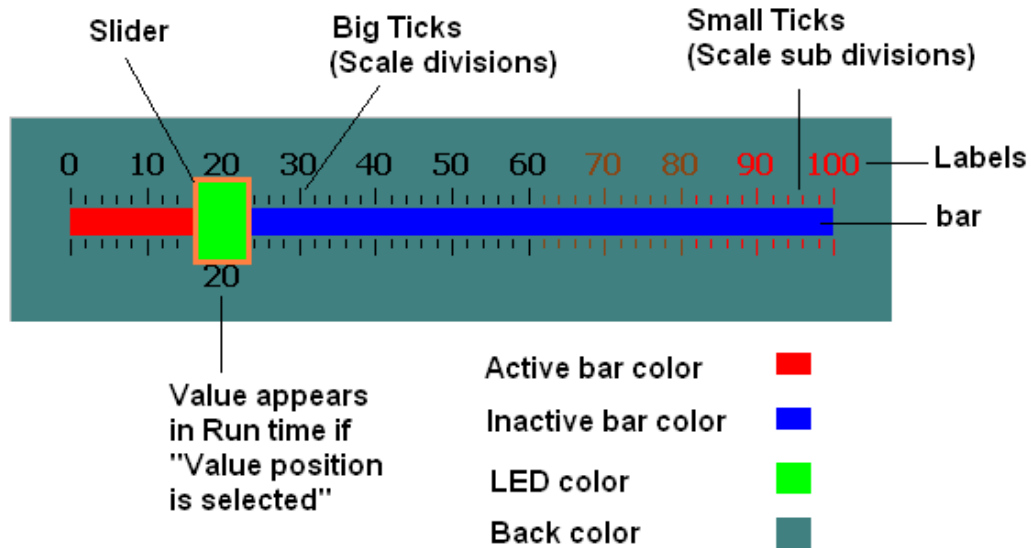

In the above figure, Scale divisions = 10 (Big ticks).
Scale sub divisions = 5 (Small ticks between big ticks).
Scale Label divisions = 10 (0, 10, 20 till 100).

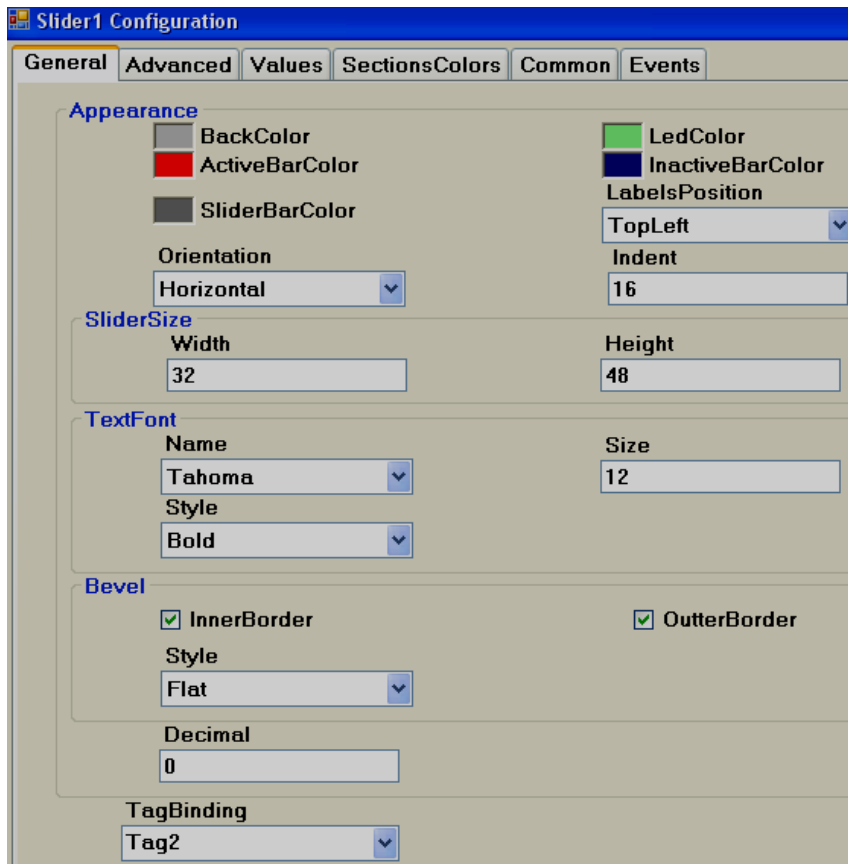

Properties

Back color: Back color for the component.

Active bar color: Define active bar color.

Slider bar color: Define border color for the slider.

LED color: Color of the handle

Inactive bar color: Define inactive bar color.

LabelsPosition: Define Label position. Available options include Top Left, Bottom Right, Both, Internal and None.

Orientation: Horizontal/Vertical. This is the orientation of the slider component. In the above figure, it is in the Horizontal position.

Slide size: Define height and width of the slider.

Text Font: It is to set the font for the label including Name of Font, Size of font and Style of font. Supported styles include Regular, Bold, Italic, Underline & Strikeout.

Bevel: It is to set a border including inner border, outer border and style of border.

Inner Border: True/False

Outer Border: True/False

Style: 9 styles are available

None, Flat, Single, Double, Raised, Lowered, Double Raised, Double lowered, Frame Raised, and Frame Lowered.

Tag Binding: Select the Analog Tag of a process value.

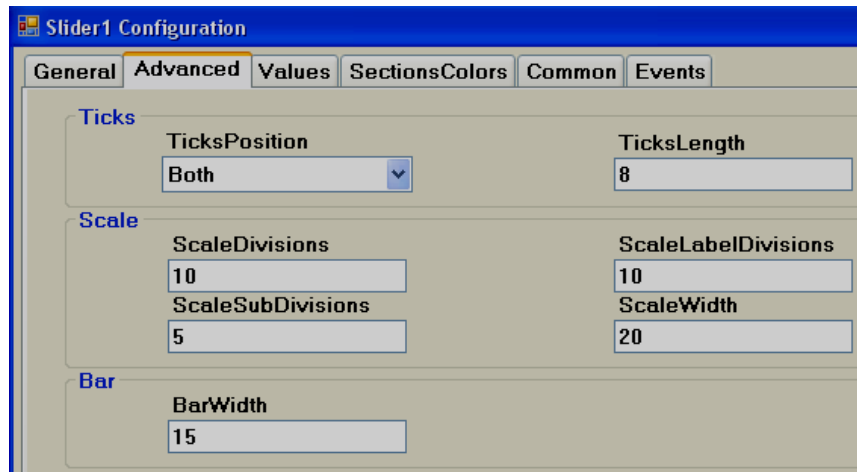

Ticks:

Ticks Position: Define ticks position. Available options include Top Left, Bottom Right, Both, Internal and None.

Ticks Length: Set Tick length in pixels

Scale:

Scale divisions: Define number of Scale divisions (Big ticks).

Scale Sub Divisions: Define number of Sub divisions (Small Ticks between big ticks).

Scale Label Divisions: Define number of Labels to appear. Ex. 0, 10, 20 etc. till 100 for scale 0 to 100.



Define same value for both Scale divisions and Scale label divisions.

Scale Width: Define Scale width.

Note: This is only the width for Scale divisions. Example: If ticks position is selected on both sides, then it is the gap between two scale ticks (Top and Bottom in Horizontal orientation or Left and Right in vertical orientation).

Bar:

Bar Width: Define width of Bar.

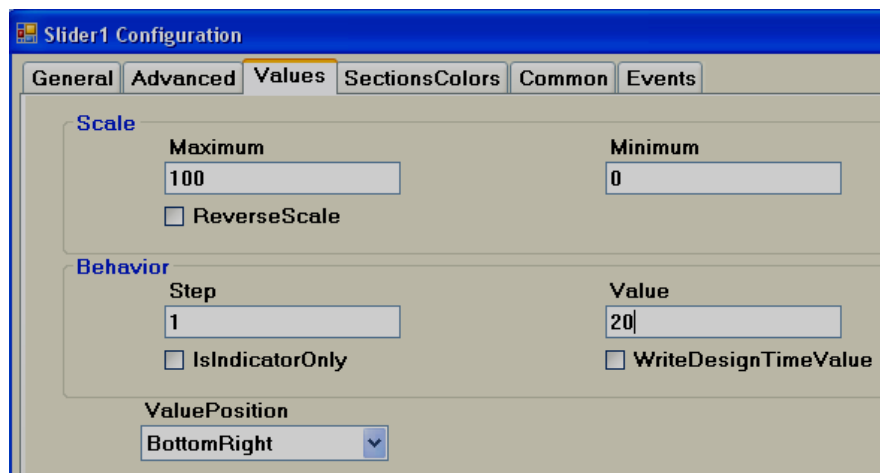

Scale:

Maximum: This is maximum range of Set point (Analog Tag, Normally Analog Output).

Minimum: This is minimum range of Set Point (Analog Tag, Normally Analog Output).

Example: If Controller set point is 0 to 100 Deg.C, set Minimum = 0, Maximum = 100.

Reverse Scale: If Selected, Scale labels will be displayed in Reverse.

Behavior:

Step: It is the minimum value change when the slider is moved.

For example: By default, Step = 0, i.e., Slider moves its position in Real time even with minor change in process value.

For example: If Step = 5, Slider moves its position in Real time in steps of 5.

Value: It is used to enter process value in design time and check the Slider position in PC.

Indicator only:



If Indicator only is selected, slider is used for Read only. Operator will be not able to move slider in Run time.

If Indicator only is not selected, the slider is used for Read/Write. Operator will be able to move slider in Run time for example: change set point for variable speed drive.

Value Position: Define position for the value to appear during Run time. Available options include Top left, Bottom Right, Both, Internal and None.

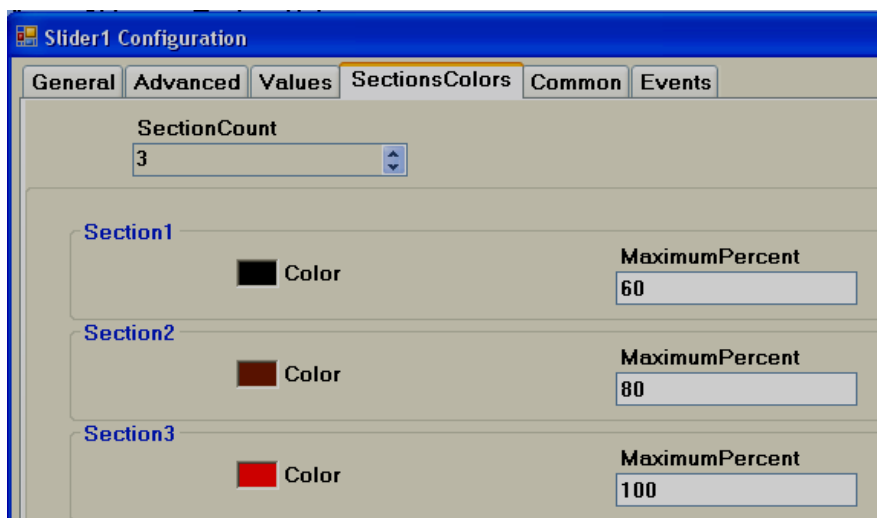

Sections colors: It is configure bands for the sections to show different colors for Labels and Ticks in Slider.

Example: Three bands

Section 1, Max% =60 means its band is from 0 to 60%. It shows labels and ticks in black color.

Section 2, Max% =80 means its band is from 61 to 80%. It shows labels and ticks in brown color.

Section 3, Max% =100 means its band is from 81 to 100%. It shows labels and ticks in Red color.

Note: Band setting is in % for the total Scale defined (Minimum to maximum).

5.3.18.5 Thermometer

This is normally used to view process temperature by operator during Run time. Generally it is linked with an analog tag (Analog input type tag at PLC, which is received as 4-20 mA signal from field transmitters like Temperature etc...)

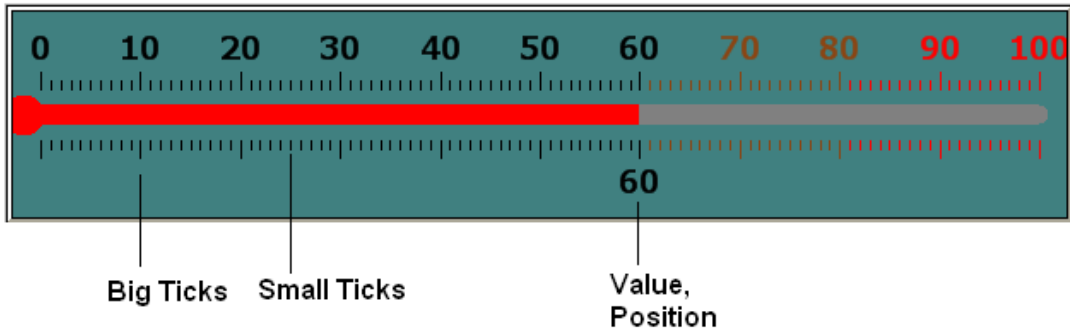

Scale Label Divisions= 10 (0, 10, 20... 100)

Scale Divisions = 10 (No.of Big Ticks)

Scale Sub Divisions = 10 (No.of Small ticks between Big Ticks)

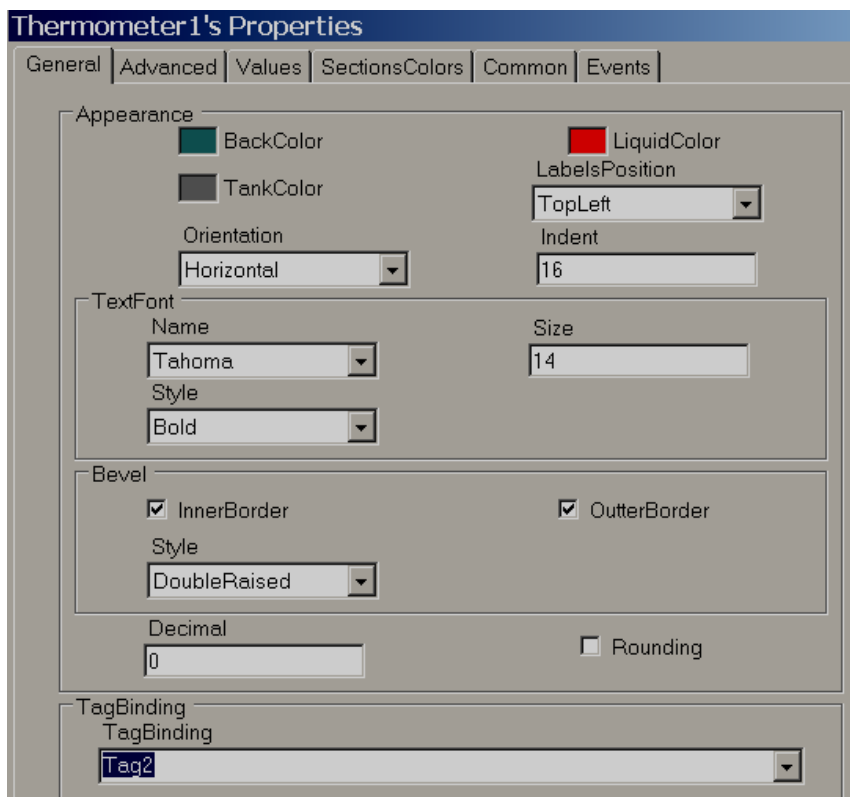

Properties

Back Color: Define back color for the component.

Liquid color: Shows temperature level (mercury) in Thermometer.

Tank Color: Define background color of thermometer without mercury.

LabelsPosition: Define Label position. Available options include Top Left, Bottom Right, Both, Internal and None. The naming convention is based on the selected orientation of the component.

Orientation: Horizontal/Vertical. This is orientation of component. In the figure above, it is in the Horizontal direction.

Indent: It is the gap between border and start of scale.

Text Font: It is to set font for the label including the Name of Font, Size of font and Style of font. Supported styles include Regular, Bold, Italic, Underline & Strikeout.

Bevel: It is to set the border, including the inner border, outer border and style of border.

Inner Border: True/False

Outer Border: True/False

Style: 9 styles are available

None, Flat, Single, Double, Raised, Lowered, Double Raised, Double lowered, Frame Raised, and Frame Lowered.

Tag Binding: Select the Analog Tag of process value.

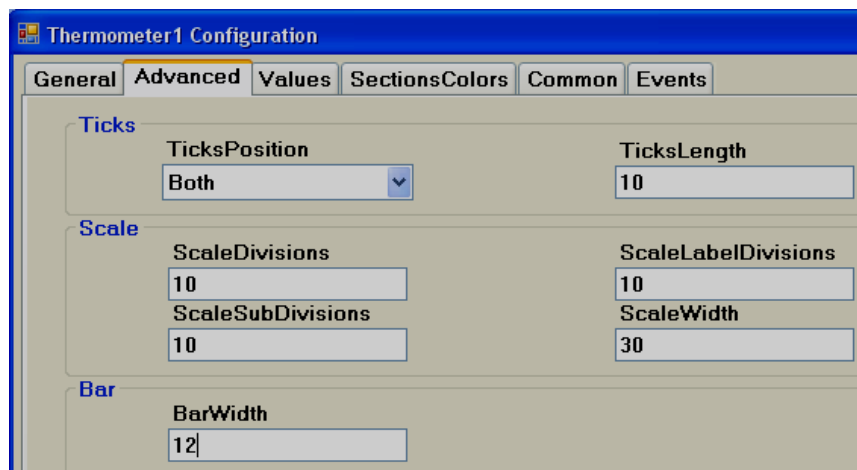

Ticks Position: Define ticks position. Available options include Top Left, Bottom Right, Both, Internal and None.

Ticks Length: Set Tick length in pixels

Scale divisions: Define number of scale divisions (Big Ticks) for the component.

Scale Sub Divisions: Define number of Sub divisions between the above scale divisions (Number of Small ticks between any two Big Ticks).

Scale Label Divisions: Define number of Labels to be displayed for component as per Scale Range of process value. For ex: 0, 10, 20, 30...100.

Scale Width: Define Scale width. If you have ticks on both sides of the component, it defines the width between Upper (Left) and Lower (Right) scale divisions based on orientation of component.

Bar Width: Define width of Bar in pixels.

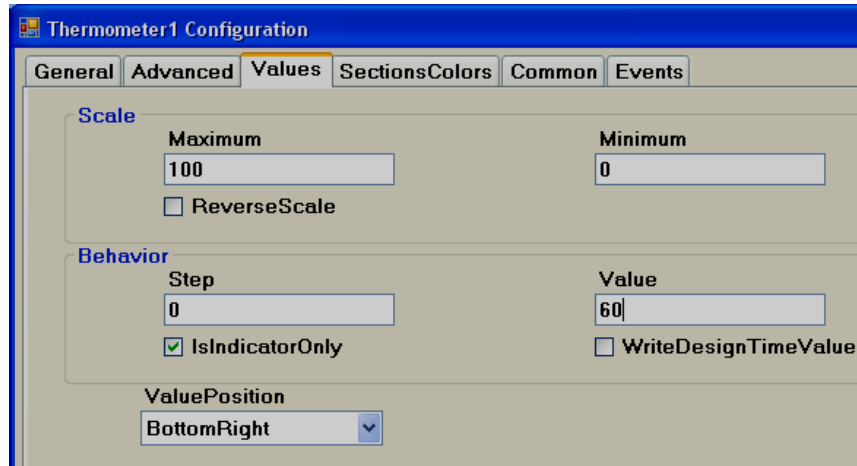

Maximum: This is maximum range of the Set point (Analog Tag, Normally this is an Analog input, 20 mA, 10V DC etc.)

Minimum: This is minimum range of Set Point (Analog Tag, Normally this is an Analog input, 4 mA, 0V DC etc.)

Example: If Temperature transmitter range is 0 to 100 Deg.C, set Minimum = 0, Maximum = 100.

Reverse Scale: True/False. Define Scale direction.

Step: It is the minimum value to reflect change of mercury level.

For example: By default, Step = 0 means the Mercury level moves in Real time even with a minor change in process value.

For example: Step = 5 means the Mercury level moves its position in Real time in steps of 5.

Value: It is used to enter a process value during design time and check mercury level position on the PC.

Indicator only: If selected, this component is used for Read only. If it is not selected, then this component can be used for Write/Read purpose.

Write design time value: If selected, it writes design time values instead of default values defined in the tag database.

Value Position: Define position for the value to appear during Run time. Available options include Top left, Bottom Right, Both, Internal and None. The naming convention is based on the orientation of the component.

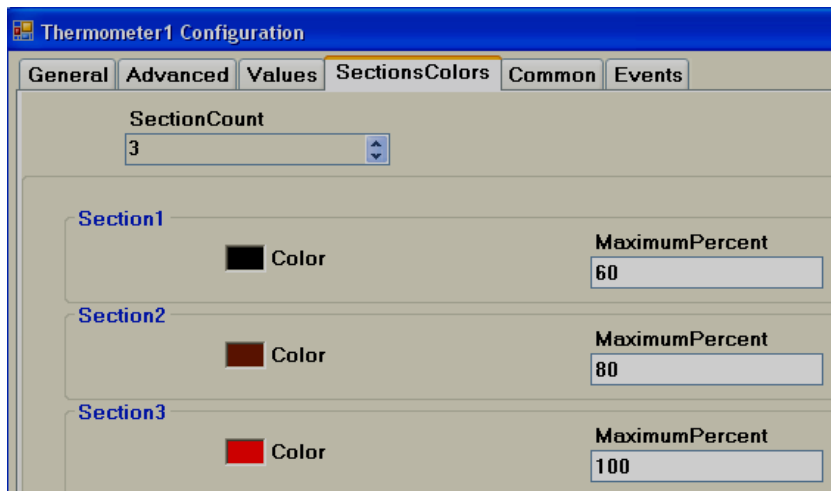

Section Colors: Define bands to display Ticks and Label color accordingly based on the value of the tag during Run time.

5.3.18.6 Bar Box

Bar Box is a Graphical User Interface widget that displays a bar graph for an Analog Tag during Run Time.

Every Bar box should be linked with an **Analog** Tag.

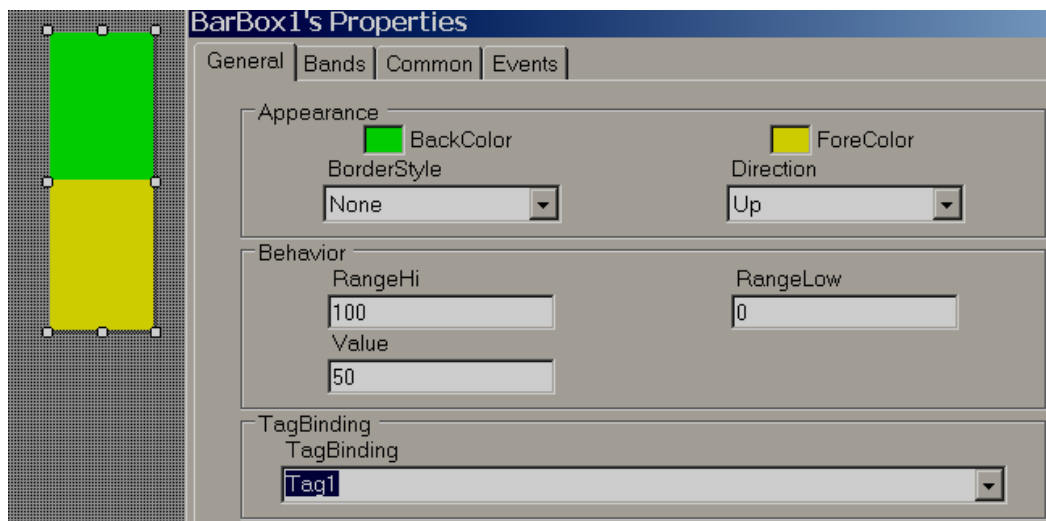

Properties

Border Style: Define border style. Options include Fixed single, Fixed 3D and None.

Direction: Define direction of Bar graph. Up/Down/Left/Right

Range high: Display scale high.

Range Low: Display scale low.

Value: Default value. It is to check how fore color, back color displays in PC during design time.

Tag Binding: Select the Analog Tag of process value.

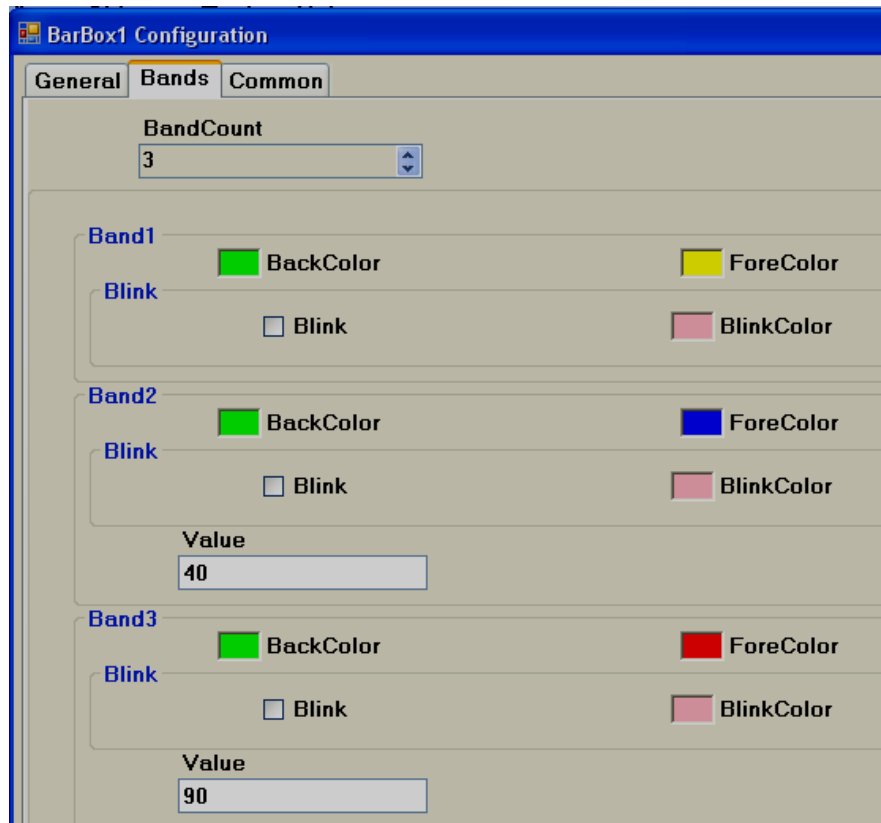

Bands

It is to define various bands for the process value to appear and display animation in Run time.

Band count: Use up/down buttons to increase/decrease number of bands. Maximum 32 bands are supported. In each band, it is possible to configure back color, fore color and blink properties.

Back color: Define back color.

Fore Color: Define fore color.

Blink: Select "True" if blink is required and "False" if blink is not required.

Blink color: If "True" is selected for blink, then this property is visible and you can select required blink color.

Value: It is the band range. For the first band, it is always the Range Low value defined for the bar box. Band 1 high range is the value defined at Band2. Band 2 high range value is the value defined at Band3 and so on.

5.3.18.7 Scale

Scale is a Graphical User Interface widget used along with bar box if required.

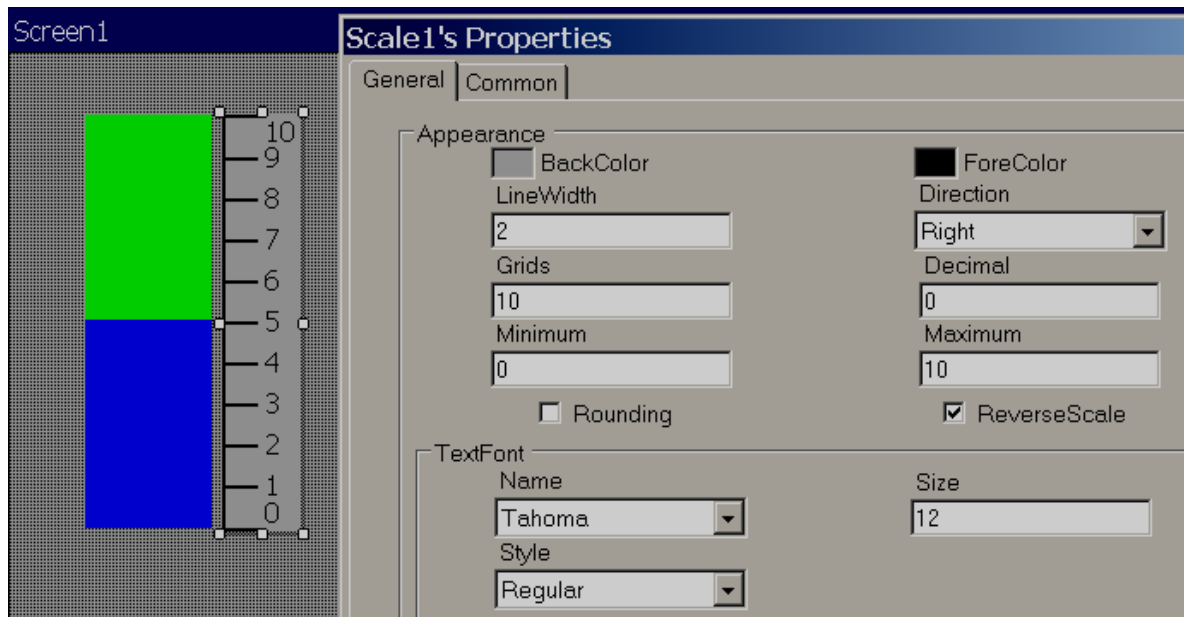

Properties

Back color: Define back color

Fore Color: Define fore color

Line width: Define width of line

Grids: Define number of grids

Direction: Define direction of Scale. Up/Down/Left/Right

5.3.18.8 Picture box

Picture box permits the user to link different picture files into a Picture box component during design time and then later view them during Run time based on the value of the Tag. Supported formats include

- Bitmap file (*.bmp)
- Windows Metafile (*.wmf)
- JPEG File (*.jpg)

Graphics Interchange format (*.gif)
Portable Network Graphic (*.png)

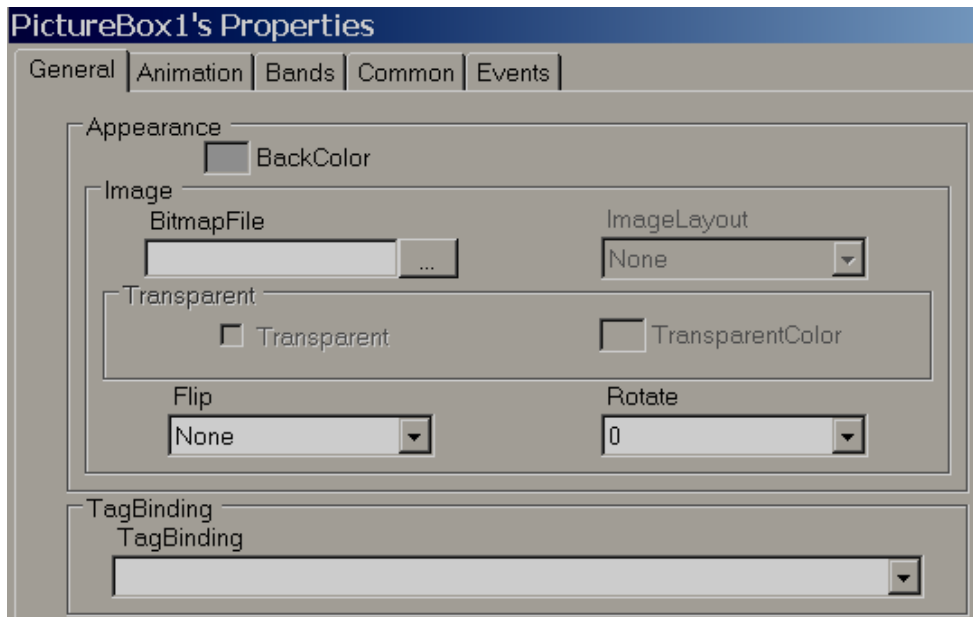

Properties

Bitmap file Select the image to be shown in the object

Flip: It is to flip picture file during design time. Available options are Horizontal, Vertical, Both and None.

Rotate: It is to select direction for the picture file during design time to adjust direction. Available directions include 0°, 90°, 180° and 270°

Tag Binding: Select the Analog tag to be linked with Picture box.

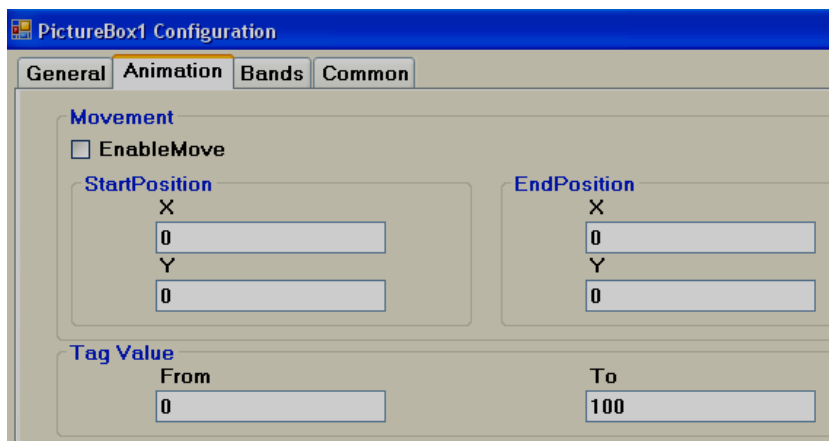

Movement: Select “Enable Move” if it is required to move picture during Run time from Location 1 to Location 2 based on a tag Value. Start and End coordinates for X and Y needs to be configured during Design time, and the Picture moves in Run time based on a Tag value.

Tag Value: Define Tag value

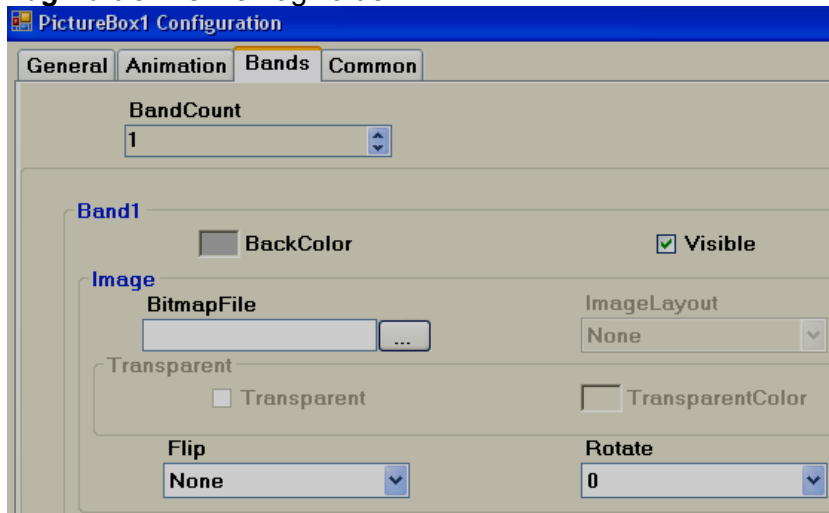

Band Count: Define number of bands required.

Back Color: Define back color for the selected picture file in specific band.

Visible: Define visibility for the picture in specific band.

Bitmap file: Select picture file for specific band.

Image Layout: Position of image within Picture container. Available options include None/Center/Stretch. When stretch is selected, it attempts to fit the picture file to the size of container.

Transparent: Select if no back color is required for picture file.

Flip: It is to flip picture file during design time. Available options are Horizontal, Vertical, Both and None.

Rotate: It is to select the direction for the picture file during design time to adjust direction. Available directions include 0°, 90°, 180° and 270°

Example: You may take a photo of a section of the factory floor like a tank, then use this on the Recorder screen instead of a default symbol.



A bitmap file by the name sunset.jpg is linked with PictureBox1 in screen1. If you wish to have the same sunset.jpg in screen no2, do not create picture box and link with sunset.jpg again. Since a resource with name sunset already available, if you try to use the same image in other place, it may not allow you to do so, and may give you an error message. If you really need the same image again, copy picture box1 at screen1 and paste it in screen no 2.

5.3.19 Graphics

Graphics are used to place a symbol in a screen like a Tank, Motor etc... Basic symbols are available in Recorder Editing Software and it includes the following symbol categories.

Symbol categories

	Category	Symbols	Colors	Qty
1	Arrows	7	6	42
2	Blowers	5	6	30
3	Boilers	4	6	24
4	Conveyors	6	6	36
5	Instruments- True Color	7	C	7
6	Lamps	4	6	24
7	Material handling	8	C	8
8	Motors	4	6	24
9	Nature-True Color	6	C	6
10	Office-True Color	7	C	7
11	Pipes	10	6	60
12	Power-True Color	7	C	7
13	Pumps	5	6	30
14	Push buttons	8	6	48
15	Tanks	5	6	30
16	Valves	8	6	48
17	Vehicles-True Color	6	C	6

C = True Color

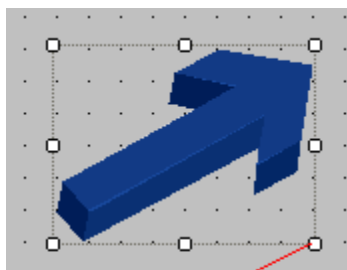
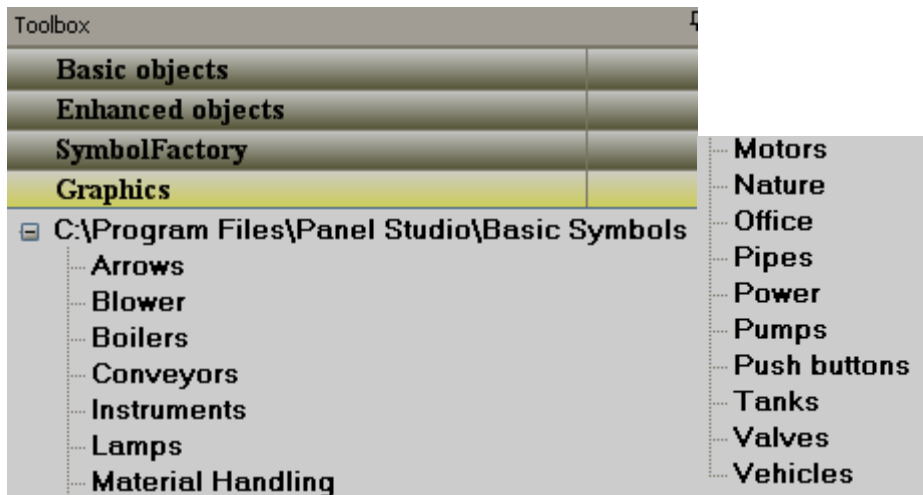

Use these cursor points to change the size

Some symbols are available with 6 different colors. They are Red, Green, Yellow, Blue, Brown and Grey.

All the symbols are vector graphics. They occupy less memory and have high quality.

It is possible to set the transparent property for symbols during design time from the property grid. "Transparent" means the screen color itself will appear as back ground color, making the object appear to be see-through. Also, it is possible to change the symbol background color during design time and Run time.

How to set the "transparent property to a symbol from the property grid

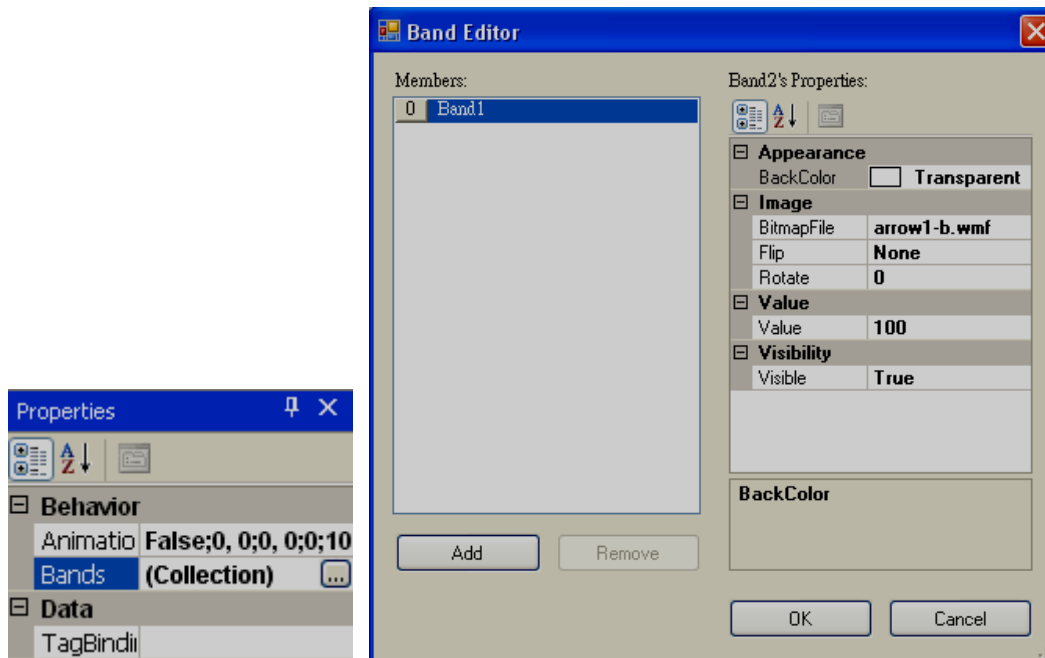

Click "Bands", then set "BackColor" to "Transparent"

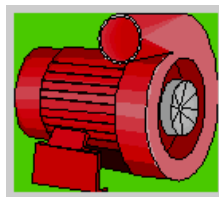
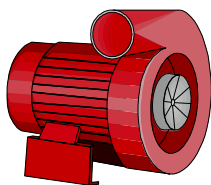

Fig: Back color=Transparent

Fig: Back Color=Green

Since all symbols are vector symbols, if a symbol is enlarged, it does not lose quality.

When Recorder Editing Software is installed, all basic symbols will be installed in the default folder C:\Program Files\Recorder Editing Software\Recorder Editing Software\Basic Symbols

In addition, if the application developer has any additional symbols, they can be placed in the same folder as the basic symbols for use in the project.

Example: Create a folder named "Custom", and place it in C:\Program Files\Recorder Editing Software\Recorder Editing Software\Basic Symbols

It is possible to a set path for graphic symbols in the Recorder software. On the Menu bar, click the "File" dropdown menu, select "Environment", then select "Graphics path". All these will appear in a tree type structure within Recorder editor avoiding the need to import these symbols using a "Picture Box".

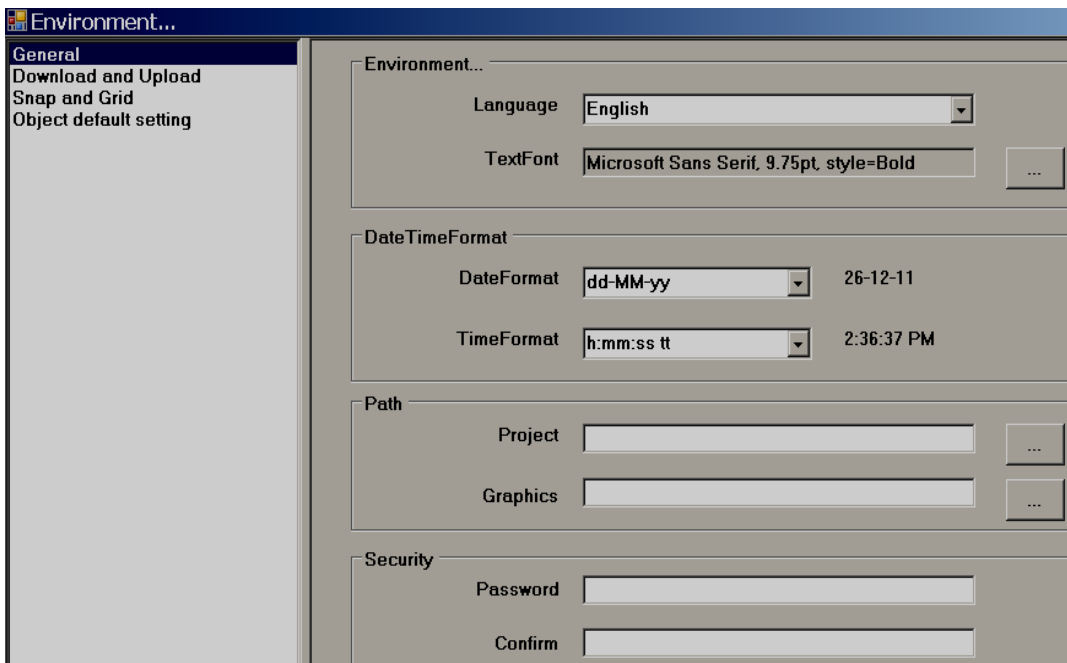
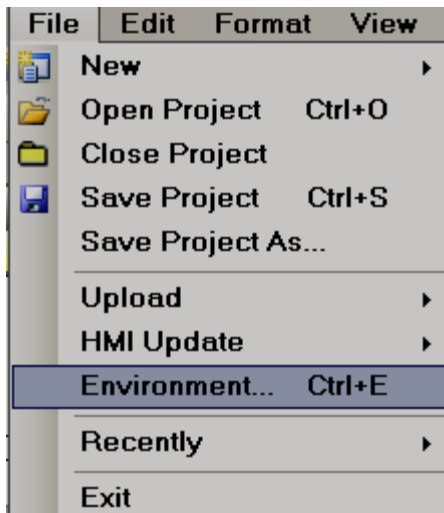

Once a symbol is selected in the Recorder from Graphics, it is possible to change, Flip or rotate basic symbols in 0° , 90° , 180° and 270°

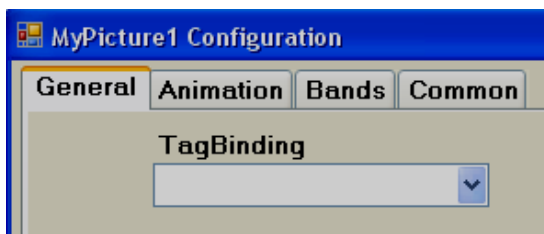

Properties

Tag Binding: Select an Analog Tag if animation is required for the symbol in Run time.

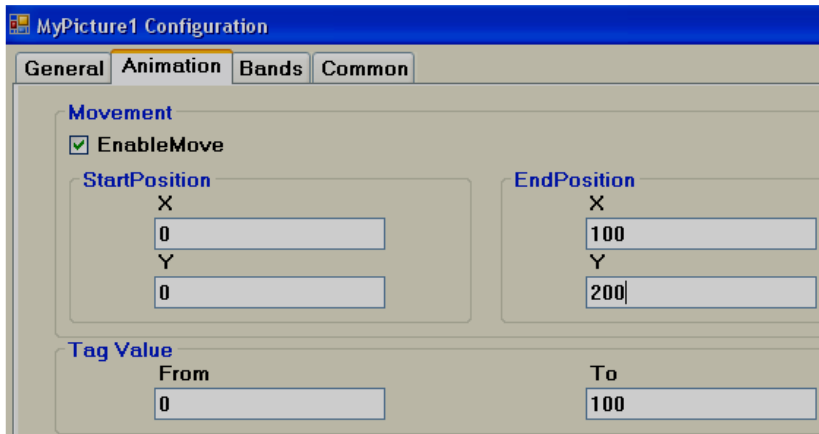

Movement: Select the Enable/Move checkbox, then, enter the X and Y start and end positions (this is in pixels).

Tag Value: Linked with the Start and End Positions.

Ex: Recorder 7" (High Performance), Screen Resolution = 800 X 480, Horizontal installation, Width=800, Height=480. Move symbol from Left to Right of screen during Run time when tag value changes from 0 to 100

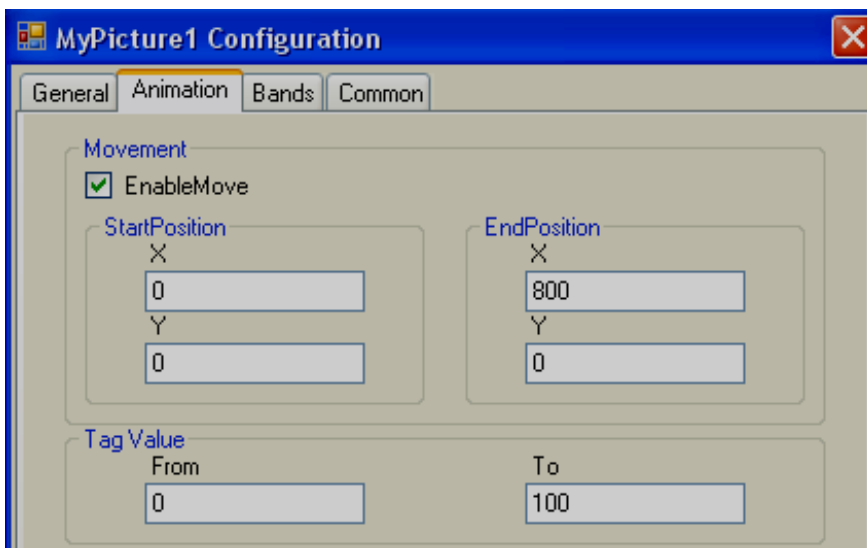

To move the symbol from Left to Right, set start and end Positions for X coordinate in pixels, there is no need to set Y coordinates.

Tag value = 0 corresponds to Start Position (X)

Tag value = 1000 corresponds to End Position (X)

Ex: Recorder 7" (High Performance), Screen Resolution = 800 X 480, Horizontal installation, Width=800, Height=480. Move symbol from Top to Bottom in screen at Run time when tag value changes from 0 to 100

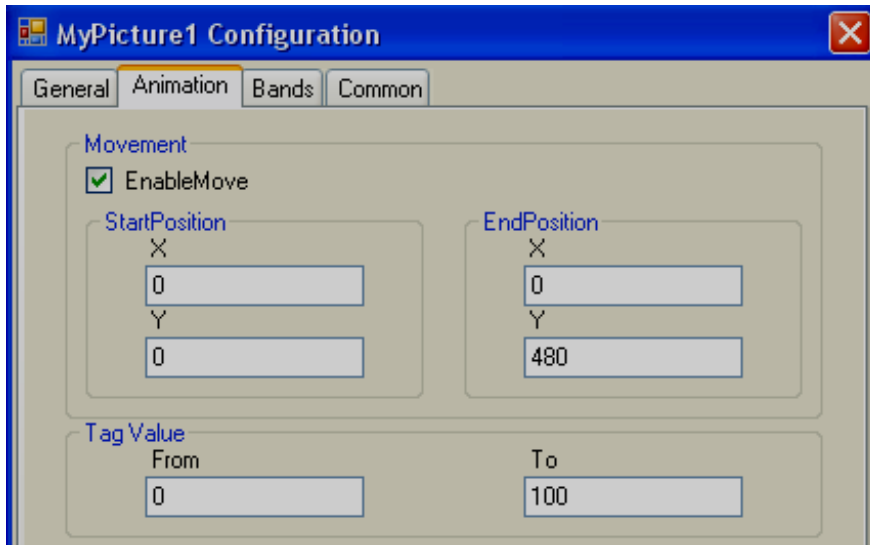

Ex: Recorder 7" (High Performance), Screen Resolution = 800 X 480, Horizontal installation, Width=800, Height=480. Move symbol from Left Top to Right Bottom on screen at an angle during Run time when the tag value changes from 0 to 100

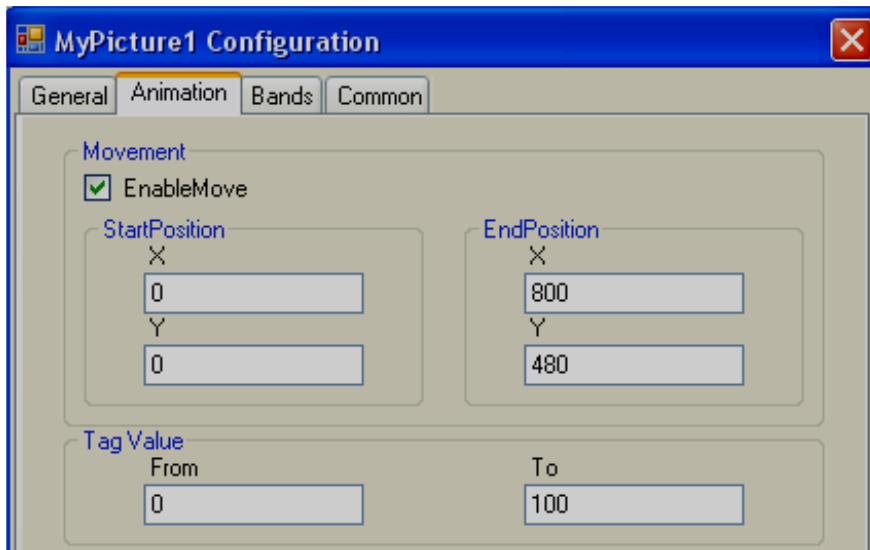

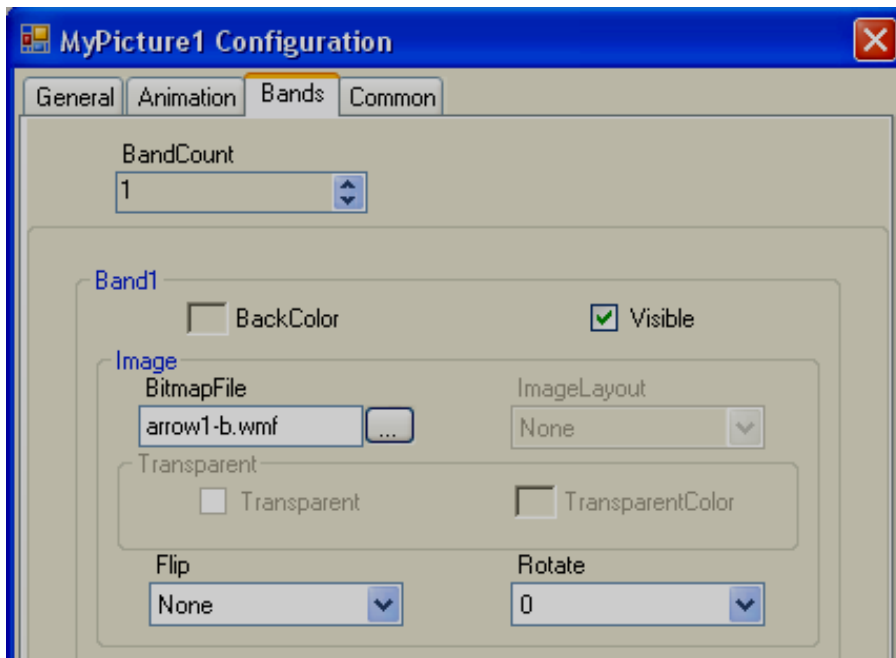

Band Count: Used to define bands for run time animation of symbol. Max. 32 bands are supported.

Back Color: Define Back Color of the symbol that should appear in a specific band during Run time.

Visible: Define visibility control for the symbol in a specific band during Run time.

Image: Select different image file to display in a specific band during Run time.

Flip: Define the flip position for the symbol in a specific band during Run time. Available options include None, Horizontal, Vertical and Both.

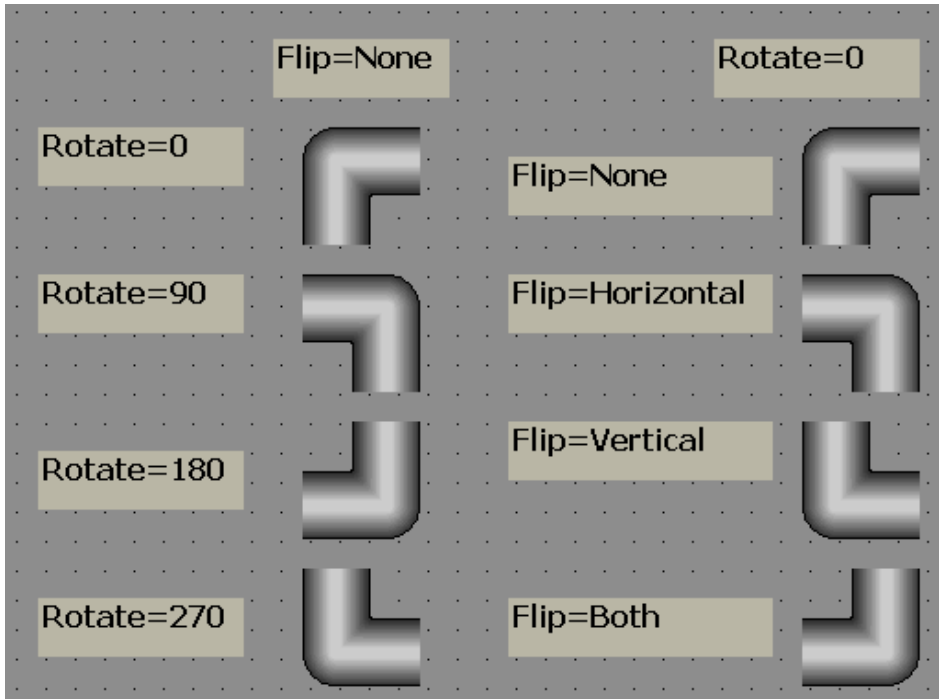

Rotate: Rotate symbol to any predefined direction in a specific band during Run time. Available options include 0°, 90°, 180° and 270°

Example: There is Liquid level Tank. When the Tag value =0, an arrow should appear pointing in the Down direction indicating that a discharge of the tank is in progress. When the Tag value = 1, the arrow should appear in the Up direction indicating filling of tank is in progress.

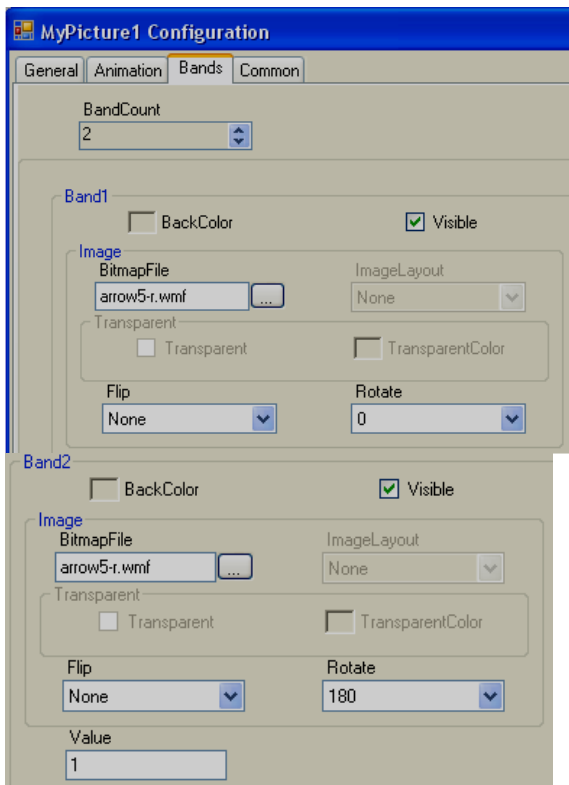

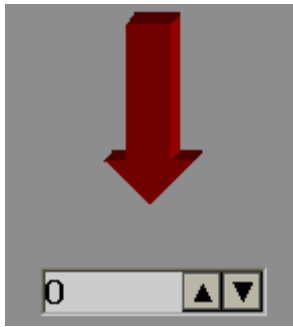

5.3.20 Symbol Factory

Symbol Factory® contains more than 4000 symbols in 64 categories.

No.	Category	Symbols	No.	Category	Symbols
1	3-D Pushbuttons Etc.	73	35	Machining	90
2	Air Conditioning	140	36	Maps and Flags	23
3	Architectural	49	37	Material Handling	118
4	Arrows	63	38	Mining	63
5	ASHRAE Controls & Equipment	100	39	Misc. Pipes	39
6	ASHRAE Ducts	86	40	Misc. Symbols 1	57
7	ASHRAE Piping	49	41	Misc. Symbols 2	79
8	Basic Shapes	86	42	Mixers	24
9	Blowers Etc.	34	43	Motors	38
10	Boilers	36	44	Nature	71
11	Buildings	42	45	Operator Interface	28
12	Chemical	50	46	Panels	14
13	Computer Hardware	38	47	Pipes	82
14	Computer Keys	68	48	Plant Facilities	52
15	Containers	56	49	Power	61
16	Controllers	35	50	Process Cooling	20
17	Conveyors, Belt	40	51	Process Heating	61
18	Conveyors, Misc.	26	52	Pulp & Paper	35
19	Conveyors, Simple	56	53	Pumps	99
20	Ducts	51	54	Safety	27
21	Electrical	83	55	Scales	36
22	Finishing	45	56	Segmented Pipes	41
23	Flexible Tubing	24	57	Sensors	55
24	Flow Meters	35	58	Tank Cutaways	23
25	Food	72	59	Tanks	145
26	General Mfg.	68	60	Textures	181

27	Heating	108	61	Valves	73
28	HVAC	74	62	Vehicles	41
29	Icons and Bitmaps	159	63	Water & Wastewater	112
30	Industrial Misc.	19	64	Wire & Cable	21
31	International Symbols	42		Total	4045
32	ISA Symbols	183			
33	ISA Symbols (3-D)	123			
34	Laboratory	23			



With Recorder Editing Software, only the first symbol from the symbol factory can be selected. If you need all symbols, order our Recorder Editing Software Plus, and we will supply a USB hardware lock to access more than 4000 symbol factory graphics.



It is possible to link a Analog Tag with a Symbol factory graphic and change its colors during Run time. Up to 50 bands are supported.

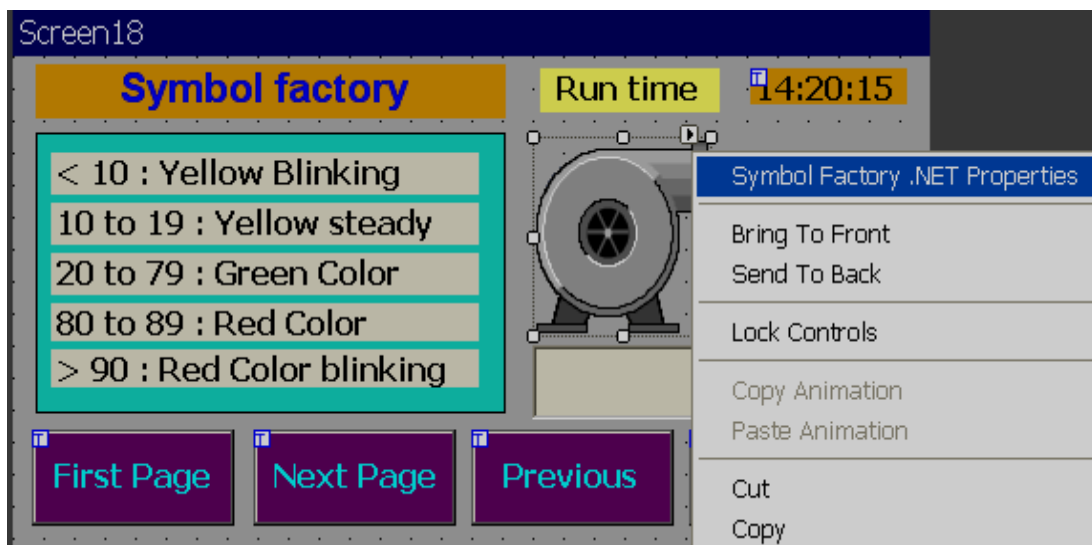
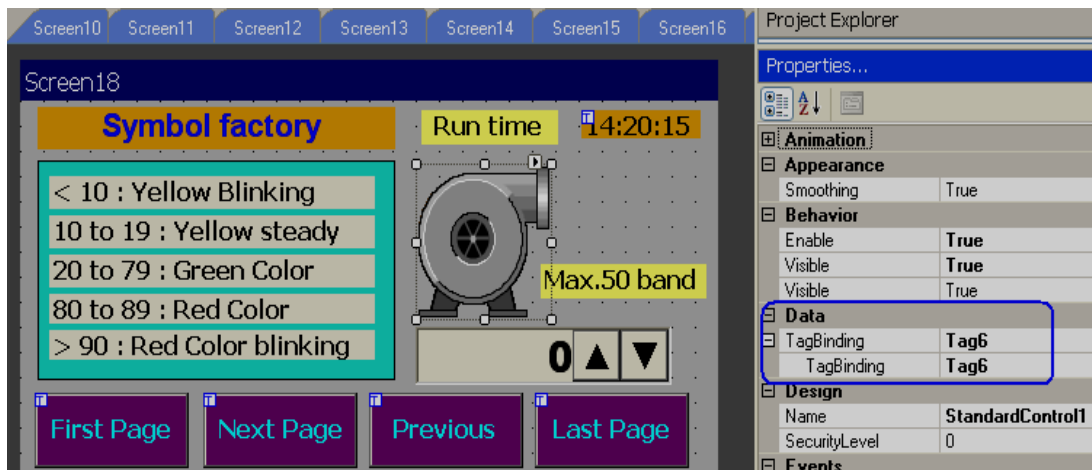

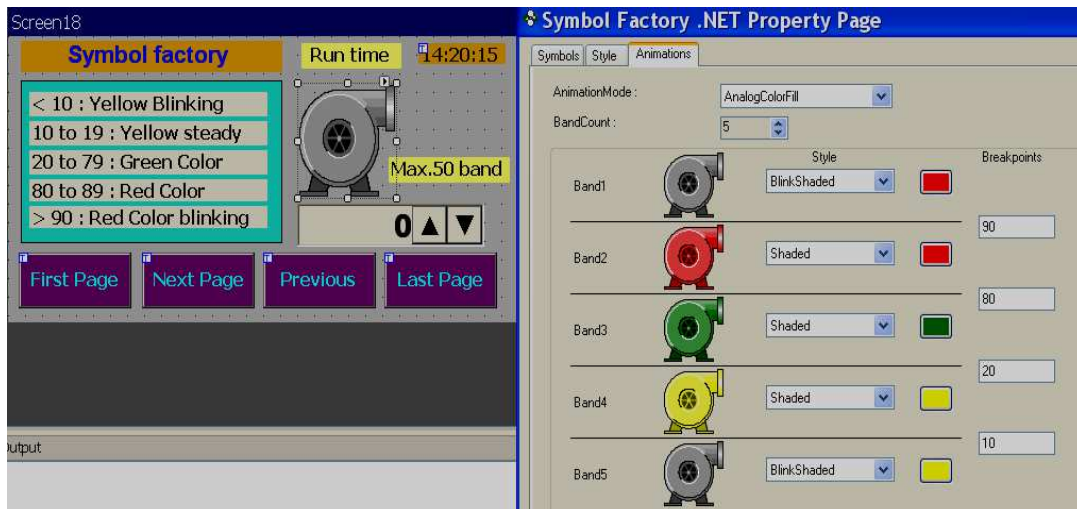

Design Time

During design time, the applications engineer is allowed to change the colors of these symbols.

Example: Change tank color from standard grey scale to Green color.

Task: Place symbol on a screen

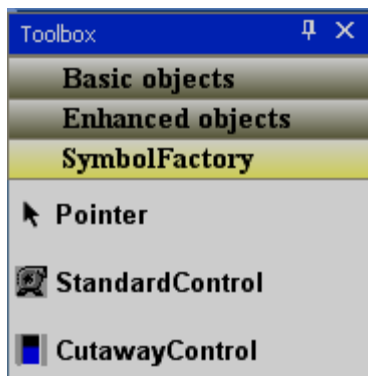

In Tool box, click “Symbol Factory”, then drag and drop a standard control to the screen.

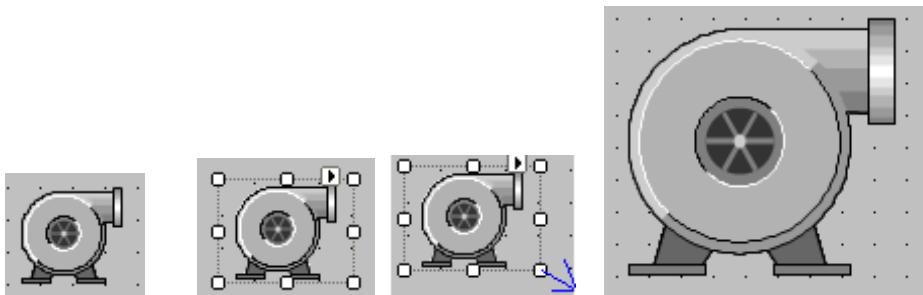

Fig 1

Fig2

Fig3

Fig4

Task: Increase size of symbol

Select the symbol on the screen. It will be as shown as in fig2 above.

Then, move mouse to a square pointer till an arrow appears. Left-click and hold the mouse. Drag the mouse to increase size of symbol as per your requirement and then it will be as shown as in Fig4 above. Alternatively, in the property grid, enter the size in pixels as shown below.

Size	120, 100
Height	100
Width	120

Task: Changing symbol to another category

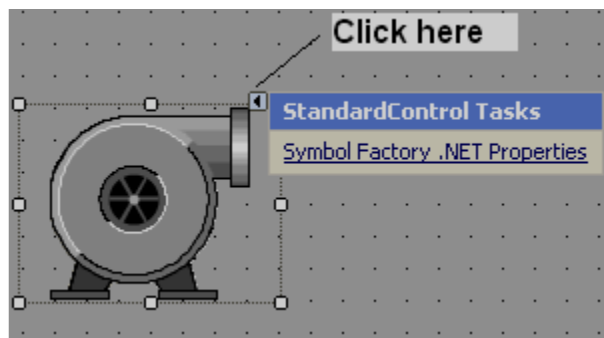

Drag and the drop symbol factory component onto a screen.

Click , then click on Symbol Factory.NET Properties.

Alternatively, select the symbol factory component using single click (left) with the mouse. Keep the mouse cursor on the symbol, then, double click (left) the mouse to open symbol properties. The following screen will pop up.

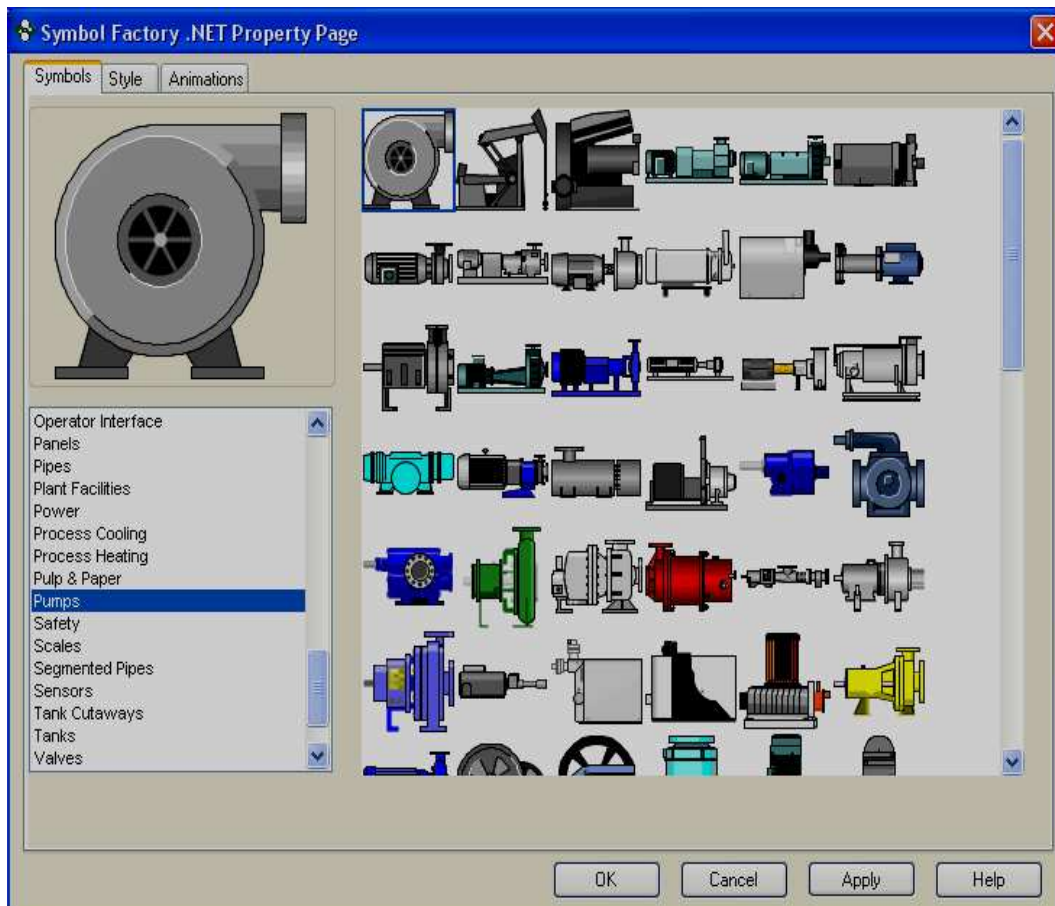

Select the required category, select the symbol, then click on button “OK”, then new symbol will be placed in screen.



Click on Help in the above screen to open a Chm type help file (English) for the symbol factory.

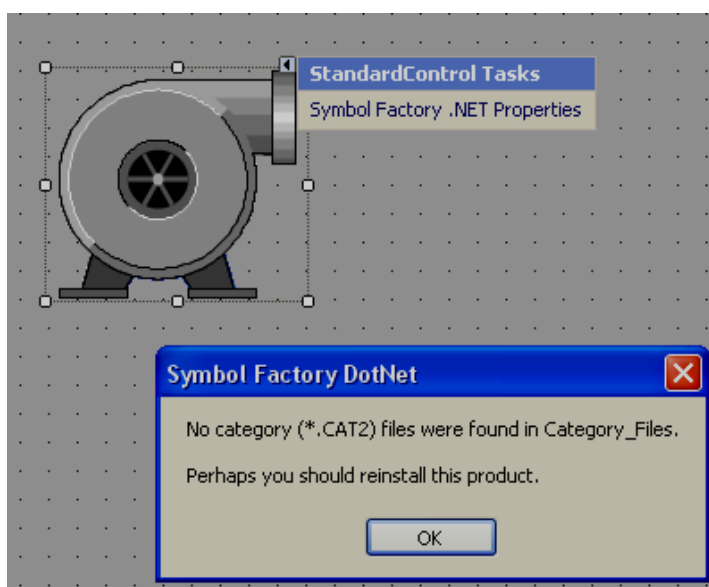

If the above error message appears, it is required to reinstall symbol factory.

Style

Used to define the style of symbol in design time.

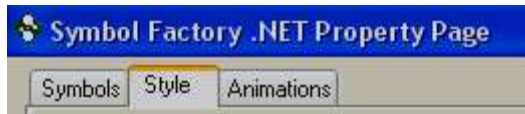

Click on "Style". The following screen will appear.

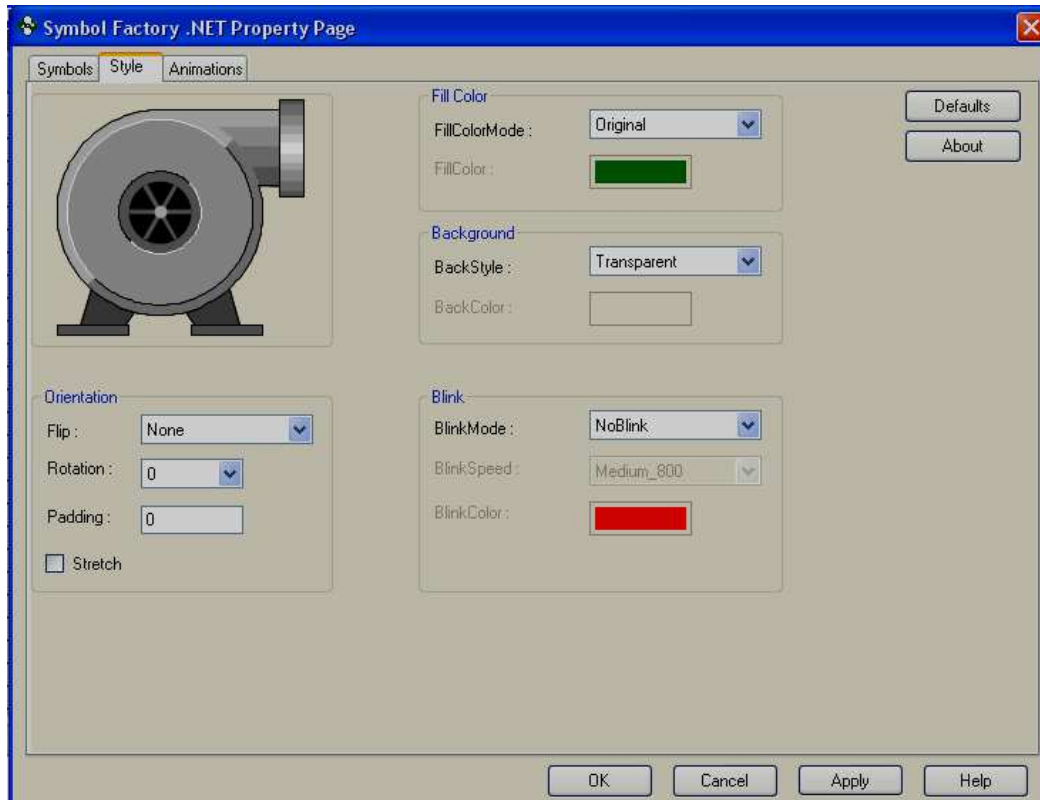
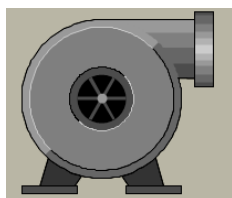

Fig: Default Style settings

Orientation:

Flip: It is possible to flip the symbol during Design time. Available options include Horizontal, Vertical, Both and None.



Flip=None

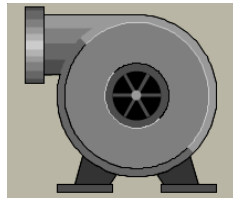

Flip = Horizontal

Rotation: It is possible to rotate symbol during design time. Available options include 0°, 90°, 180° and 270°

Padding: Normally it is 0. It is used to decrease size of symbol within selected boundaries.

Stretch: It is used to stretch symbol within selected boundaries.

Fill Color:

Fill color mode: Available options include Original, Shaded, Solid and Hollow.

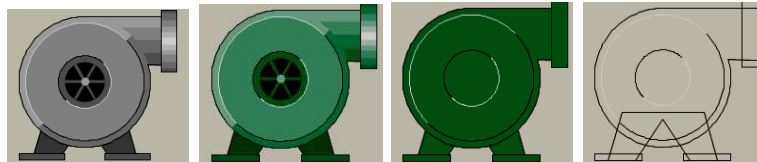

Fill Color Mode: Original
Fill Color: N.A

Shaded
Green

Solid
Green

Hollow
N.A

Fill color: Define color to be filled in Shaded and Solid fill color mode.

Background:

Back Style: Available options include Transparent & Opaque. Transparent means screen background color will appear for symbol. Opaque means, it is possible to set different background colors for a specific selected symbol.

Back color: Define background color when the back style = Opaque.

Blink:

Blink mode: Available options include No Blink, Blink Invisible, Blink shaded and Blink Solid.

NoBlink: Indicates “Blink” is not required for symbol during design time or Run time. Blink Speed and Blink color = Not available when this is selected.

BlinkInvisible: Symbol will appear and disappear cyclically during both design time and Run time per the set Blink speed. Blink color: Not Available for selection.

BlinkShaded: Symbol will flash 2 colors, one color at a time on the same symbol per the set blink speed during both design time and Run time.

Example

Fill Color mode = Shaded, Color = Green

Blink shaded setting: Blink mode=Blink shaded, Blink speed = Medium_800, Blink color = Blue

The green color shaded symbol appears first, then the symbol turns into a blue shade after elapsing the preset time in the blink speed setting.

Blink speed: Define blink speed. Available options include Fast_400, Medium_800, and Slow_1200. Its period is in *ms*.

Blink color: Define background color



Normally, blink is not used during design time. Default settings are as follows.

1. Fill Color Mode = Original. If a different color is required for the symbol, select Fill color mode = Shaded, then define the Fill color.
2. By default, Back Style = Transparent in Background
3. By Default, Blink mode = NoBlink

Animation

It is to define animation for the symbol to appear at Run time in Recorder.

Animation mode:

Define animation mode. Available options include Analog Color Fill, Discrete color fill, Analog integer color fill.

AnalogColorFill: Select this option if you wish to link an analog tag. Then define the band for the colors. For ex: 0 to 10, Color = Yellow, 10-90, Color = Green, 90-100, Color = Red etc.(See next section “How beak points work” for more details)

DiscreteColorFill: Select this option if you wish to pass discrete values like 1,2,3... during Run time to the Tag linked with symbol for the display of different colors. (See next section “How beak points work for more details)

AnalogIntegerColorFill: This is the same as Analog color fill, but only integer values are passed to the Tag linked with the symbol. (See next section “How beak points work for more details)

Band count: Defines the number of bands required for the selected Animation mode

Styles: Define style of symbols. Available options include Original, Shaded, Solid, Blink Invisible, Blink shaded and Blink solid. All definitions are the same as explained earlier.

5.3.20.1 How break points work

The idea behind Breakpoints is that certain animation will occur when a property of the component changes. If this change falls within the defined parameters (see below), an animation will be triggered.

Please note: The screen shots in the examples below are based upon the Symbol Factory .NET Standard Control, but the same principle applies to the Cutaway control.

Two types of animation can be defined based upon the setting of Animation Mode: Analog Break Points and Discrete Break points

Analog Break points (Animation Mode = Analog integer color fill or Analog color fill)

Analog breakpoints are defined as a value on which an animation will trigger when a property of the component reaches that level. Depending upon your component, different properties will need to be changed depending upon the setting of Animation Mode. These properties are:

Component	Animation Mode Setting	Property that Changes to trigger an Animation
Standard	AnalogColorFill	AnalogValue1
Standard	AnalogIntegerColorFill	AnalogIntValue1
Cutaway	AnalogColorFill	Level
Cutaway	AnalogIntegerColorFill	LevelInt

Number and Ordering of Breakpoints

The number of breakpoints available to you is the number of bands defined minus 1. As a breakpoint is defined as the point to which an animation changes, make sure you arrange the breakpoints from high to low. For example, suppose you had this screen:



When the value of your property changes, this is what will happen to the control:

Value of Property	Band that is Active	Appearance of Component
Less than 10	Band5	Blink Shaded Red
10 to < 20	Band4	Display Shaded Yellow
20 to < 80	Band3	Original
80 to < 90	Band2	Display Shaded Yellow
Greater than 90	Band1	Blink Shaded Red

If you do not order your breakpoints in a descending order, your results will be unpredictable.

Discrete break points (Animation mode = Discrete color fill)

Discrete Breakpoints aren't really breakpoints, instead, they enable animation if the "DiscreteValue" of an element in the BandsCollection is set to true.

However, since multiple DiscreteValue properties can be set at the same time, how does the component determine the animation to display? What it does is give priority to the animations based upon their order in the BandsCollection. If the first band in the collection (by default, Band1) has its DiscreteValue set to True, then that animation will be shown no matter which band also has its DiscreteValue set to true. As another example, if Band2 and Band5 each have their DiscreteValue set, the animation that is used will be the one defined in Band2.

Therefore, given the following definition of five bands:



Here is what the animations will be shown based upon different values of Discrete Value

Discrete Value for Band1	Discrete Value for Band2	Discrete Value for Band3	Discrete Value for Band4	Discrete Value for Band5	Appearance of Component
True	False	False	False	False	Blink Shaded Red (Band1)
False	True	False	False	False	Shaded Yellow (Band2)
False	False	True	False	False	Original (Band 3)
False	False	False	True	False	Shaded Orange (Band 4)
False	False	False	False	True	Blink Shaded Black (Band 5)
True	True	True	True	True	Blink Shaded Red (Band 1)
False	True	True	True	True	Shaded Yellow (Band 2)
True	False	False	False	True	Blink Shaded Red (Band 1)
False	False	False	False	False	Original (No bands active)

5.3.21 Project Tools

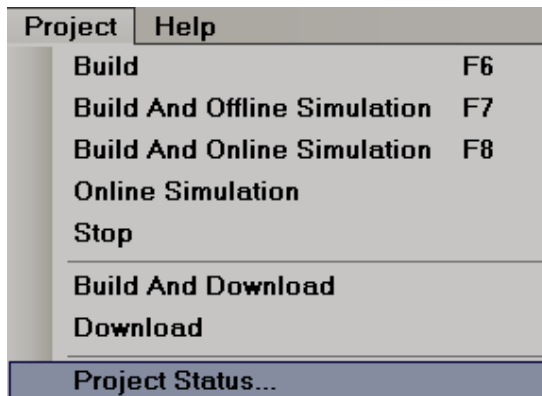

5.3.22 Build

Once the project is compiled successfully, it creates a build. This build then needs to be transferred to the Recorder. If there are any errors during the preparation of the build, it will be shown in the output window just below the screen working area. If the Output screen is not visible below the screen working area, select it via Menu, "View", and then click "Output" or apply "Reset window layout" from the Menu-"View"

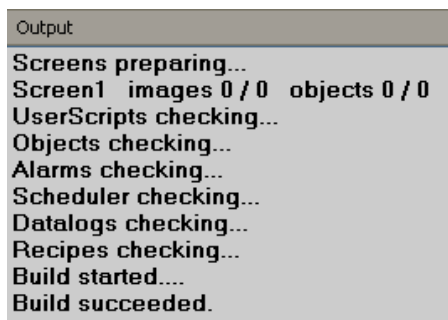

After creating a build, if any errors are shown at Output window, do not attempt to download the application from PC to Recorder, or PC to USB flash disk. First clear the errors and make sure that compilation errors are not present before transferring the application to the Recorder.

5.3.23 Build & Offline Simulation

First, it creates a build, then runs an Offline simulation.

It is used to test the application on the PC before downloading the application to the Recorder, without connecting a PLC to either PC or Recorder. It is possible to enter some values for the tags via a table to check how the application would appear during run time.

Tag	CurrentVal	SetVal
Tag1	12	
Tag2	0	
Tag3	0	
Tag4	0.0788529868553987	
Tag5	58.4416722356357	
Tag6	0	
Tag7	0.39426493427699	
Tag8	0.39426493427699	
Tag9	0	
Tag10	0	

Enter a value under the “SetVal” column, then press the enter key on your keyboard. It will accept, then show at “CurrentVal”. You will now be able to see these values in objects linked with the specific tag.



It is better to run offline simulation frequently say once in couple of hours or after completing specific screen editing by application engineer to verify how it will works on a Recorder so that if there are any compilation errors, it is easier to locate and rectify them.

5.3.24 Stop

It is used to stop a simulation on the PC. When Offline simulation is running, click the  icon to stop the current running simulation. See the picture below. It is located beneath the “help” dropdown menu.

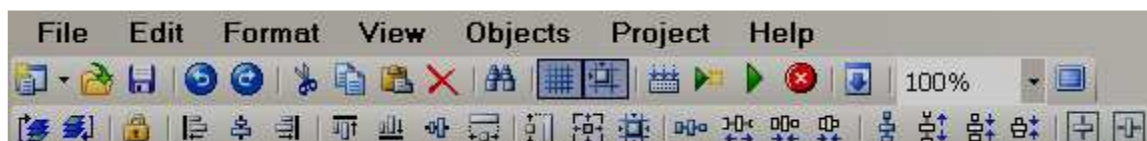





If Offline simulation or online simulation is already running on the PC, and the user attempts to run it again, the build will fail. It prompts an error message similar to the following

Screen1

Build Started....

**Could not write to Output file "C:\Program Files\Project\Recorder\Panel.exe"
"The process cannot access the file because it is being used by another process"**

Build Failed

In the case of the above message is prompted, click the Stop icon  a couple of times and make sure that icon  is not available in Task bar. Click "Build" once again, then run simulation.

5.3.25 Build & Download

It is to build first and then download application from PC to Recorder.

5.3.26 Download

It is to download application from PC to Recorder

Available options

- i) PC to Recorder via Ethernet
- ii) Removable Disk to Recorder via USB flash disk

PC to Recorder via Ethernet:

After creating an application, create a build on the PC, and make sure there are no compilation errors.

Connect Ethernet cable between PC and Recorder

In editor software, set Environment for Download via Ethernet and enter the IP address of the Recorder. In Environment, Select "Ethernet" at Download, then click the "OK" button.

In editor software, click "Project", then click "Download" or click the  icon.

The software will build and transfer the application from the PC to the Recorder. If there are any errors during compilation, they need to be fixed. Once the compilation errors are fixed, please attempt to download again.

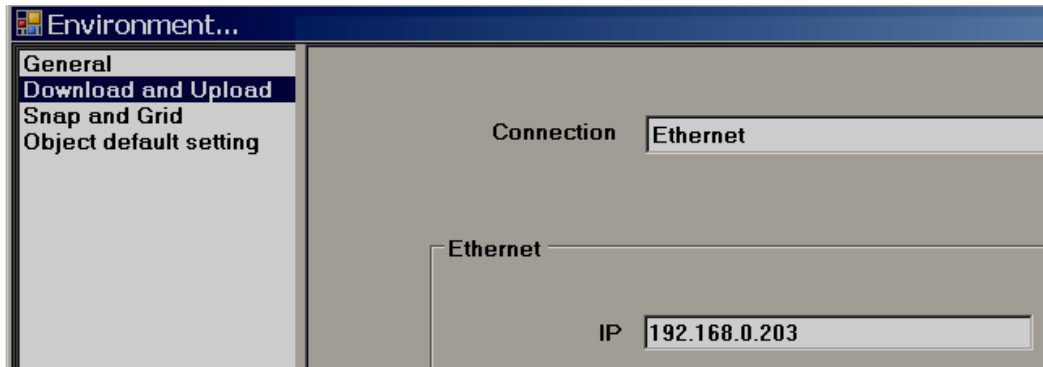

Removable disk to Recorder

After creating an application, create a build in the PC and make sure there are no compilation errors.

Connect USB flash disk in to PC via USB port.

In Recorder editor software, set “Environment” to Download via Removable disk. In Environment, Select “Removable disk” at Download and then, click the “OK” button.

In Recorder editor software, click “Project”, then click “Download” or click at  icon.

The application will transfer from the PC to the USB flash disk.

Insert USB flash disk in Recorder.

Switch on Power to the Recorder. Press “Load”, select Path of project files, then press “Load” button near path selection.

It transfers the application from the USB flash disk to the Recorder.

PC to Recorder via USB to Ethernet Converter

For Low cost Recorder models, Ethernet is an option. You can purchase a USB to Ethernet converter to make it possible to download an application from PC to Recorder via Ethernet. Once USB to Ethernet converter is connected to Recorder, you can see the IP address at the Recorder itself via system information. This is similar to onboard Ethernet port.

Note: The purpose of USB to Ethernet converter is to download application from PC to Recorder only.

5.3.27 Project status

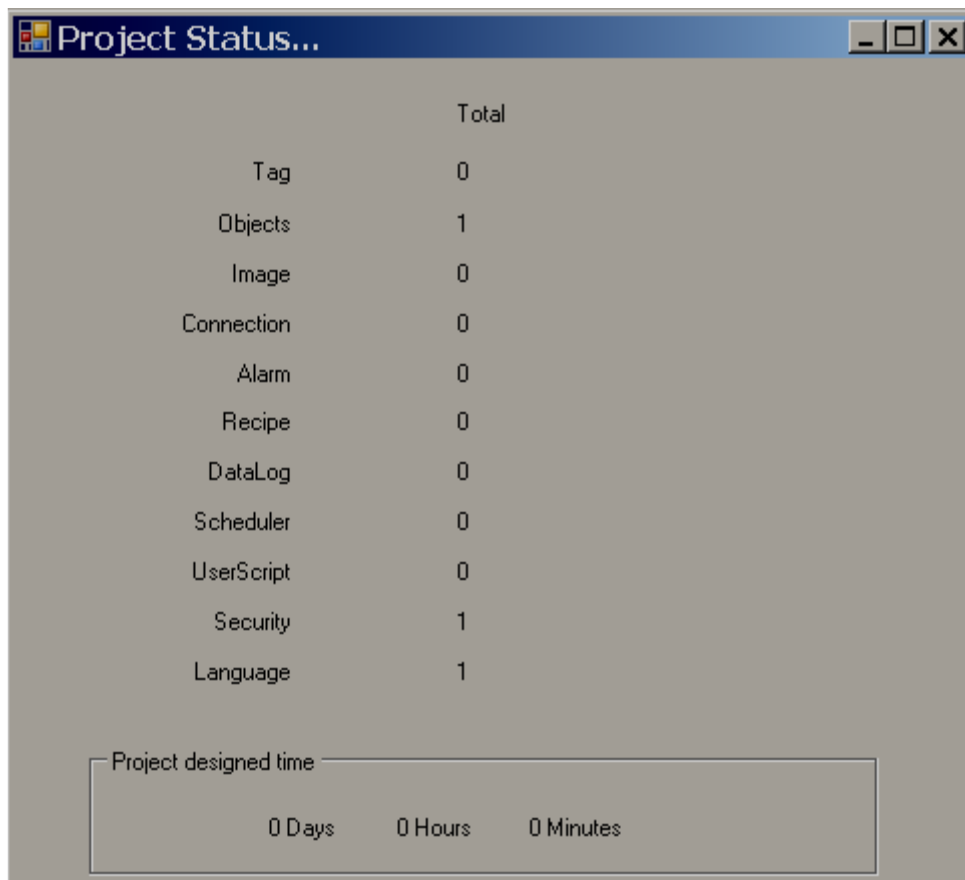

The screenshot shows a dialog box titled "Project Status...". It contains a table with two columns: the first column lists object types, and the second column, labeled "Total", shows the count for each. Below the table is a section for "Project designed time" which displays "0 Days 0 Hours 0 Minutes".

	Total
Tag	0
Objects	1
Image	0
Connection	0
Alarm	0
Recipe	0
DataLog	0
Scheduler	0
UserScript	0
Security	1
Language	1

Project designed time

0 Days 0 Hours 0 Minutes

It is used for project management purposes and to know limits and usage of objects.

Project used time: It shows how much time a project has been opened for editing purpose.

6. WEBSERVER

It is used to view Paperless Recorder from a Remote location via Internet.

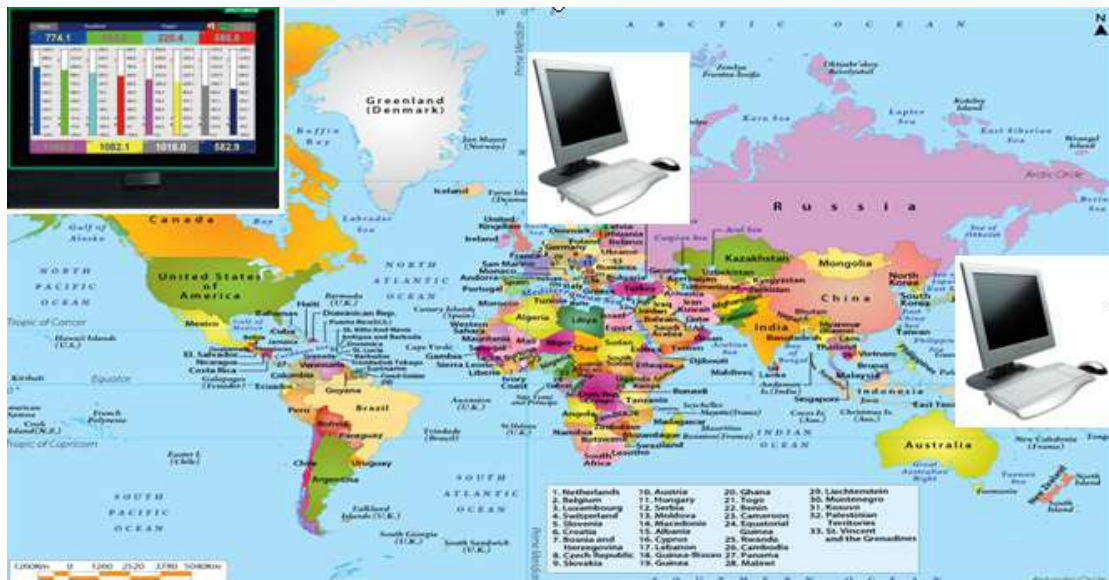

6.1 Requirements

6.1.1 Hardware

Recommended hardware:
PC with 3G GHz processor, 512 MB RAM.
5.0GB free space in the hard disk.
Ethernet port, RJ 45 female.

6.1.2 Operating system

Windows based Operating systems, Windows XP, Windows 7, Windows 8 etc.
32 bit and 64 bit operating systems are supported.

6.1.3 Browser Requirements

Internet Explorer 10 or higher
Google Chrome

6.1.4 IP Address Requirements

A Static IP address is required for the recorder.

Obtain a Static IP address from your Internet service Provider (ISP). This IP address should be unique.

Once the IP address is configured in the Recorder, use a Ping Instruction from the DOS prompt first to verify there is successful communication between the Recorder and the PC via Internet.

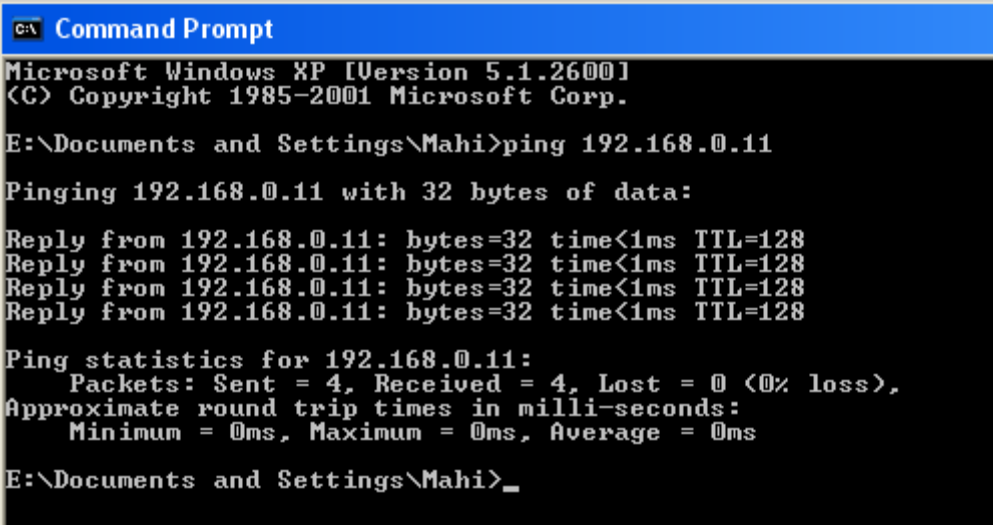
A screenshot of a Windows Command Prompt window. The title bar is blue and contains the text 'C:\ Command Prompt'. The main area is black with white text. The text shows the following command and output:

```
Microsoft Windows XP [Version 5.1.2600]
(C) Copyright 1985-2001 Microsoft Corp.

E:\Documents and Settings\Mahi>ping 192.168.0.11

Pinging 192.168.0.11 with 32 bytes of data:

Reply from 192.168.0.11: bytes=32 time<1ms TTL=128
Reply from 192.168.0.11: bytes=32 time<1ms TTL=128
Reply from 192.168.0.11: bytes=32 time<1ms TTL=128
Reply from 192.168.0.11: bytes=32 time<1ms TTL=128

Ping statistics for 192.168.0.11:
    Packets: Sent = 4, Received = 4, Lost = 0 (0% loss),
    Approximate round trip times in milli-seconds:
        Minimum = 0ms, Maximum = 0ms, Average = 0ms

E:\Documents and Settings\Mahi>_
```

Fig: Response from the Recorder for the Ping instruction from PC

6.2 How to configure Web server Settings

For using Web server application in the PR series Recorder, Configuring the Recorder for a static IP address, and enabling the Web server.

6.2.1 How to Configure Static IP Address

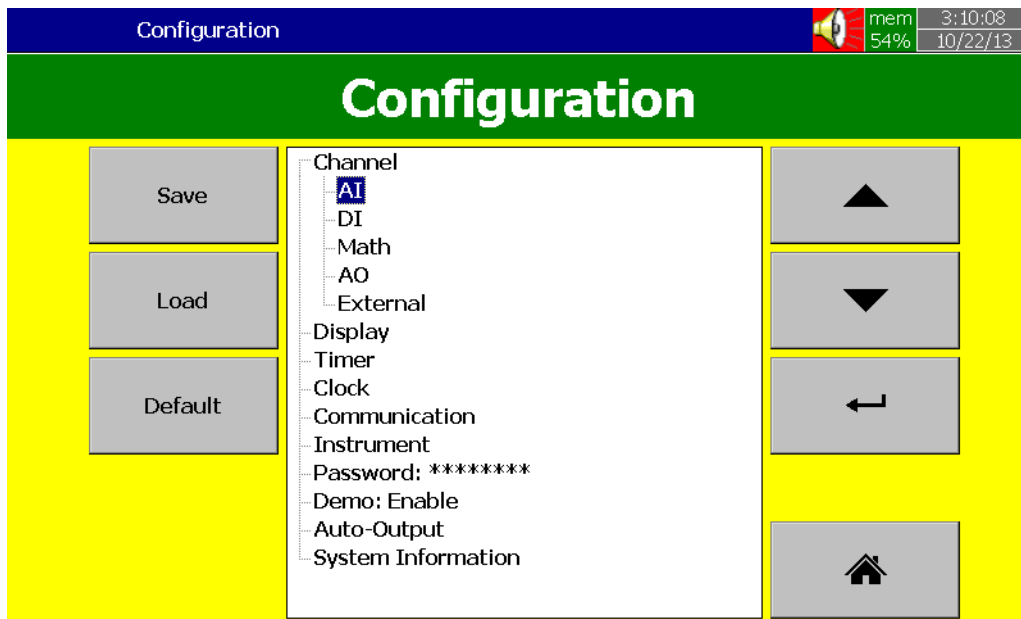

In the Configuration screen, select “Communication”, then press the “Enter” soft key.

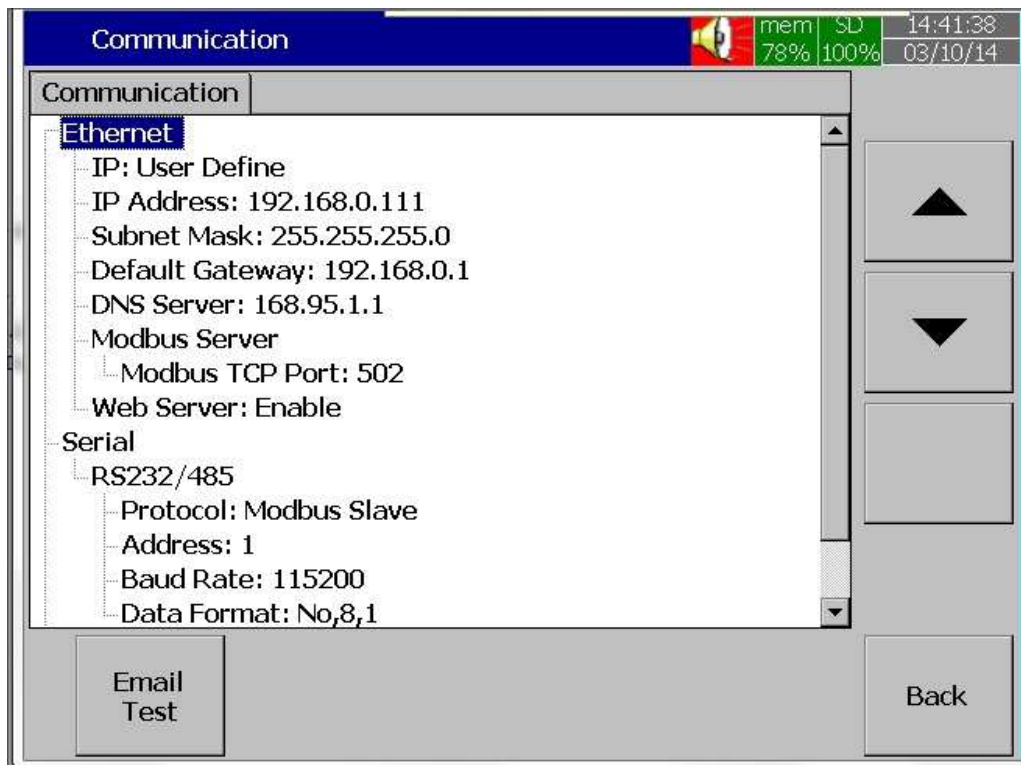

Select IP type = User Define.

Enter the IP Address, Subnet Mask, Default Gateway, and DNS Server Settings in the Ethernet Settings.

Note: Make sure to enter Global, Unique, static fix IP address received from Internet solution provider.

6.2.2 How to Enable Web Server

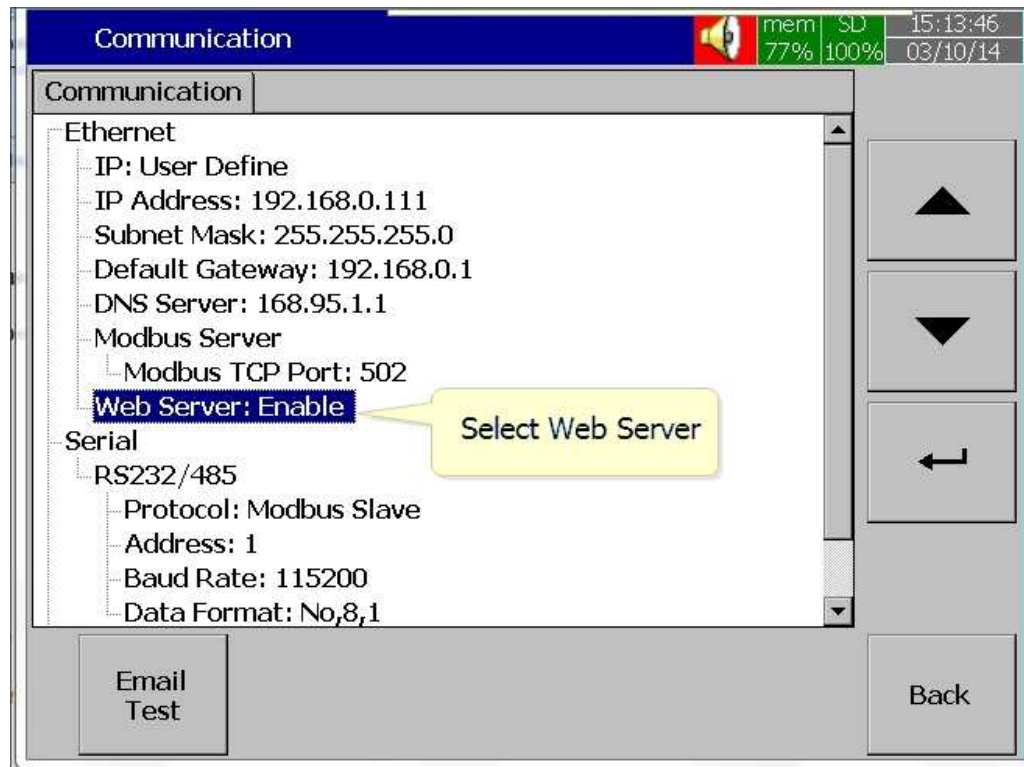

Select Web Server Menu in the Communication screen.
Enable the Web Server for using Web Server application in the Recorder.

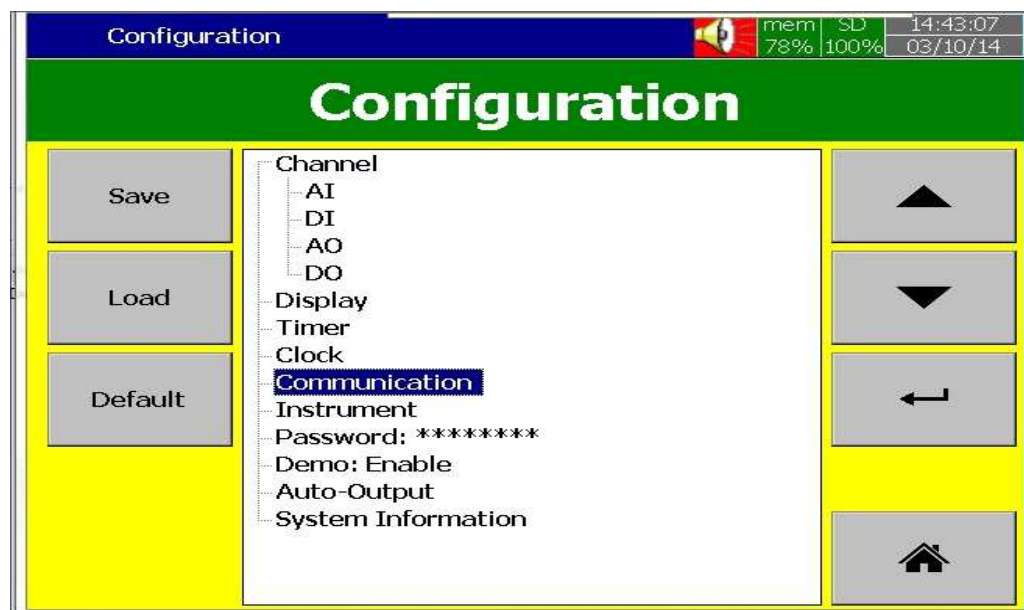

After completing the above steps, press the "BACK" key, then the "Home" key to return to the main menu. It will save the configuration settings in the Recorder.

Now the Recorder is ready for the Web Server Applications.

Note: The Web Server update time on the browser is 1 second for real time data and statuses and 5 Seconds for Alarms.

6.3 How to View Recorder Data in PC via Webserver:

Connect Paperless Recorder to the Internet

Open the browser (Internet Explorer 10 or Google Chrome) in the PC



Enter the IP address of the Recorder in the address bar of the browser.

Format: `http://192.168.1.111`

Now you can see the Paperless Recorder screens in browser as shown below



The display includes Real time values of all channels like AI, Math, Counters, Totalizers, Real time alarms, historical alarms, status of Digital Inputs, Digital Outputs, Analog Outputs, Counters, and Totalizers etc...

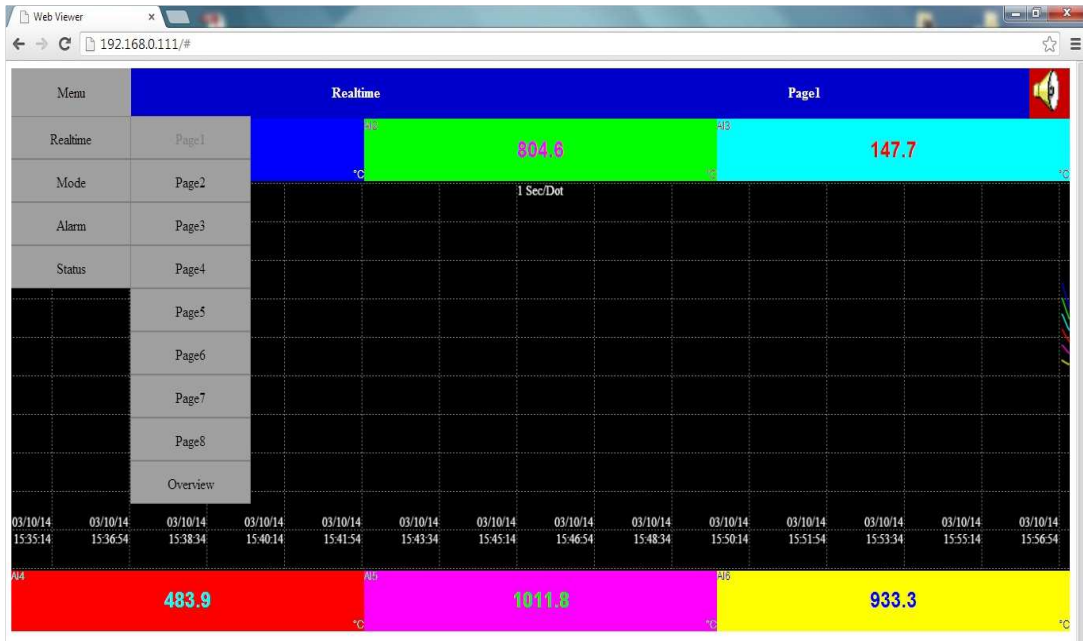

Press Overview to view the summary of all data in single screen



By pressing “Mode”, you can view the data in Bar Graphs, Trends and Digital Values.

By Pressing Trend you can view the data in trends.

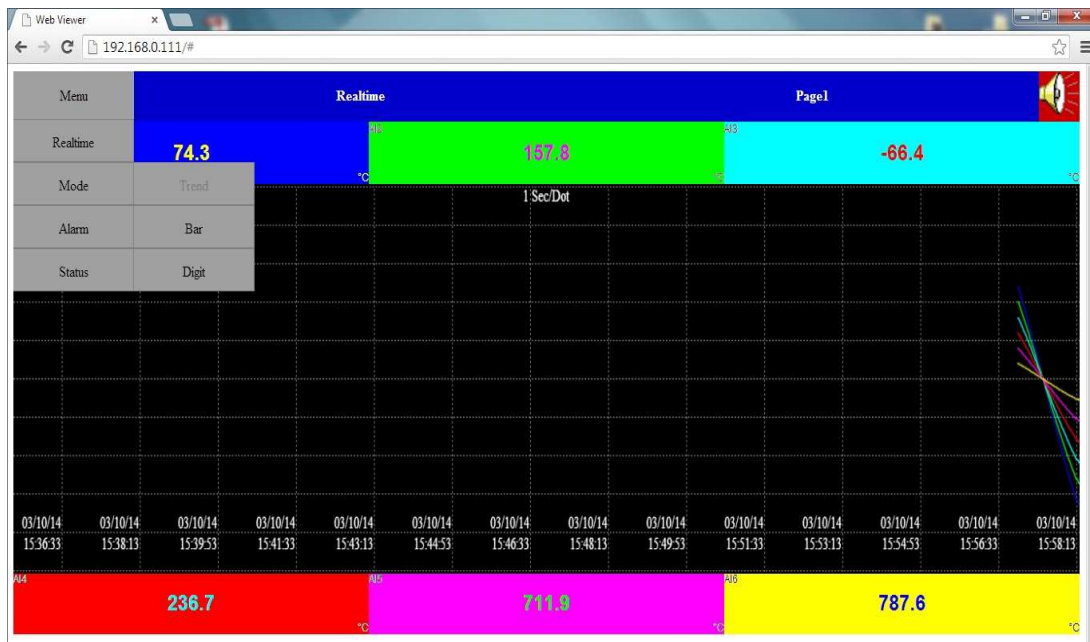

By pressing “Bar”, you can view the data in Bar Graphs

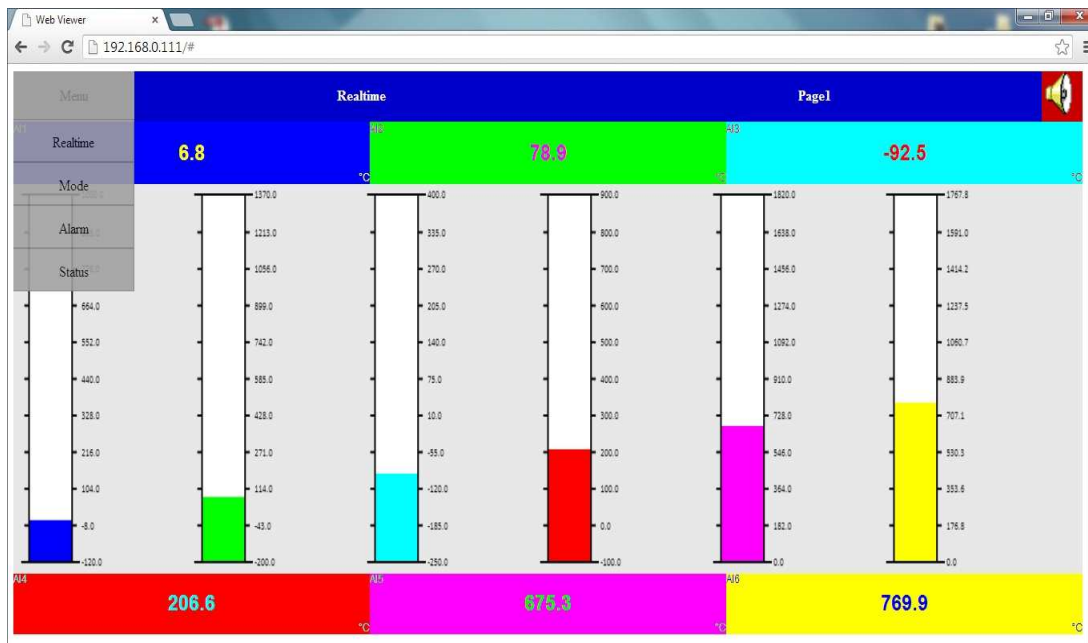

By pressing “Digit”, you can view the Data in the digital format

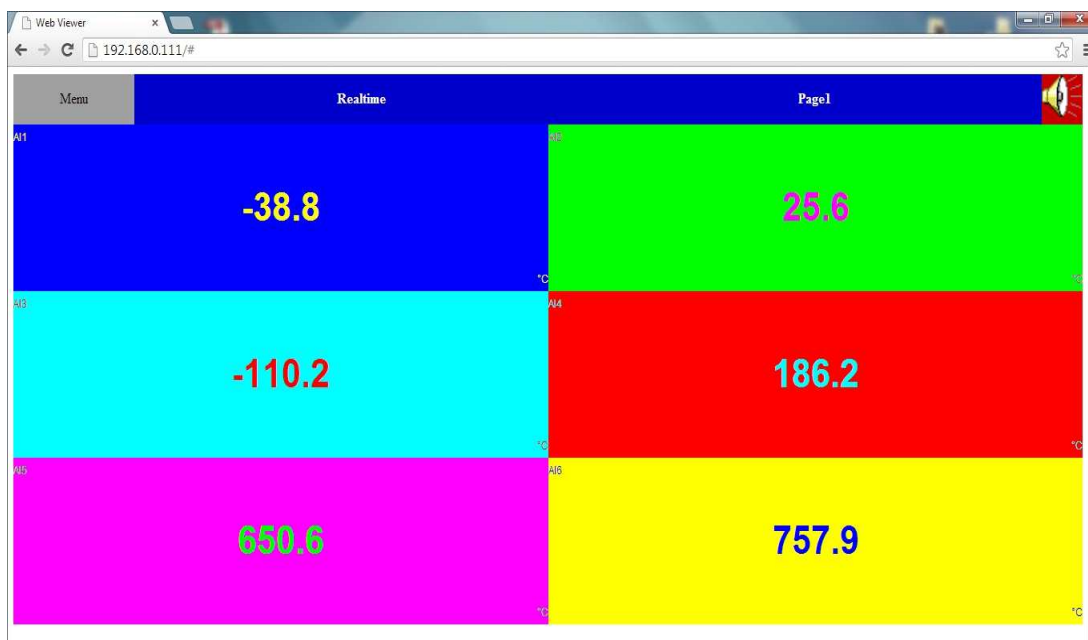

By pressing “Alarm”, you can view the List of Alarms along with the details

No.	Active Time	Acked	Type	Name	Value
1	02/10/14 16:12:12		LoAlarm	AT7	-76.10
2	02/10/14 16:12:12		LoAlarm	AT7	-76.10
3	02/10/14 16:12:12		LoAlarm	AT8	33.40
4	02/10/14 16:12:12		HiAlarm	AT19	1817.00
5	02/10/14 16:12:12		HiHiAlarm	AT19	1817.00
6	02/10/14 16:12:12		HiAlarm	AT20	2248.80
7	02/10/14 16:12:12		HiHiAlarm	AT20	2248.80
8	02/10/14 16:12:12		HiAlarm	AT21	251.50
9	02/10/14 16:12:12		HiAlarm	AT23	96.40
10	02/10/14 16:12:12		LoAlarm	AT15	19.50
11	02/10/14 16:12:12		HiHiAlarm	AT22	85.30
12	02/10/14 16:12:12		LoAlarm	AT16	11.70
13	02/10/14 16:12:12		HiAlarm	AT1	776.30
14	02/10/14 16:12:12		HiAlarm	AT14	80.10
15	02/10/14 16:12:12		LoAlarm	AT17	19.80
16	02/10/14 16:12:12		HiAlarm	AT2	1058.20
17	02/10/14 16:12:12		HiHiAlarm	AT1	981.20
18	02/10/14 16:12:12		HiHiAlarm	AT2	1178.40
19	02/10/14 16:12:12		HiAlarm	AT3	270.80
20	02/10/14 16:12:12		LoAlarm	AT19	237.40
21	02/10/14 16:12:12		LoAlarm	AT20	226.80
22	02/10/14 16:12:12		LoAlarm	AT18	67.80
23	02/10/14 16:12:12		HiAlarm	AT7	1437.20
24	02/10/14 16:12:12		LoAlarm	AT20	21.10
25	02/10/14 16:12:12		LoAlarm	AT21	-189.30
26	02/10/14 16:12:12		HiAlarm	AT8	1842.20
27	02/10/14 16:12:12		HiHiAlarm	AT7	1558.00
28	02/10/14 16:12:12		HiHiAlarm	AT8	2121.80
29	02/10/14 16:12:12		HiAlarm	AT9	370.30
30	02/10/14 16:12:12		LoAlarm	AT22	19.80
31	02/10/14 16:12:12		HiAlarm	AT10	18.20
32	02/10/14 16:12:12		LoAlarm	AT10	37.80

By pressing “Status”, you can view the status of the Analog outputs, Digital Inputs, Digital Outputs, Counters and Totalizers.

By pressing “DI”, you can view the status of the Digital Inputs

DI	DO	AO	Counter	Totalizer
No.	Name	Value	Description	
1	DI1	Hi		
2	DI2	3		
3	DI3	Hi		
4	DI4	3		
5	DI5	Hi		
6	DI6	3		

By pressing “DO”, you can view the status of the Digital outputs

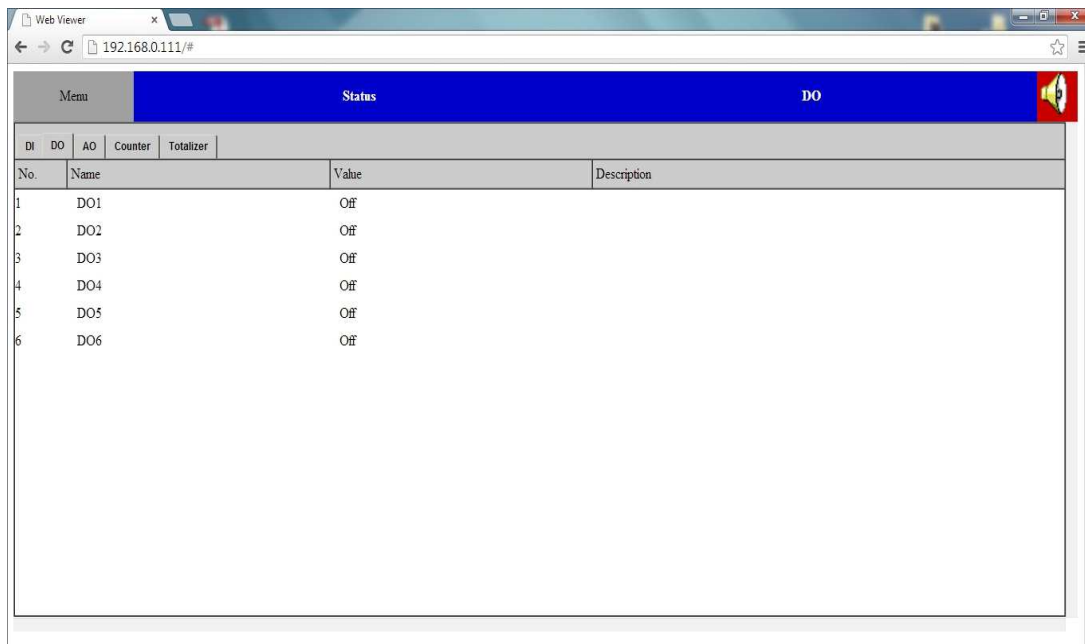

DI	DO	AO	Counter	Totalizer
No.	Name			
1	DO1			
2	DO2			
3	DO3			
4	DO4			
5	DO5			
6	DO6			

No.	Name	Value	Description
1	DO1	Off	
2	DO2	Off	
3	DO3	Off	
4	DO4	Off	
5	DO5	Off	
6	DO6	Off	

By pressing “AO”, you can view the status of the Analog Outputs

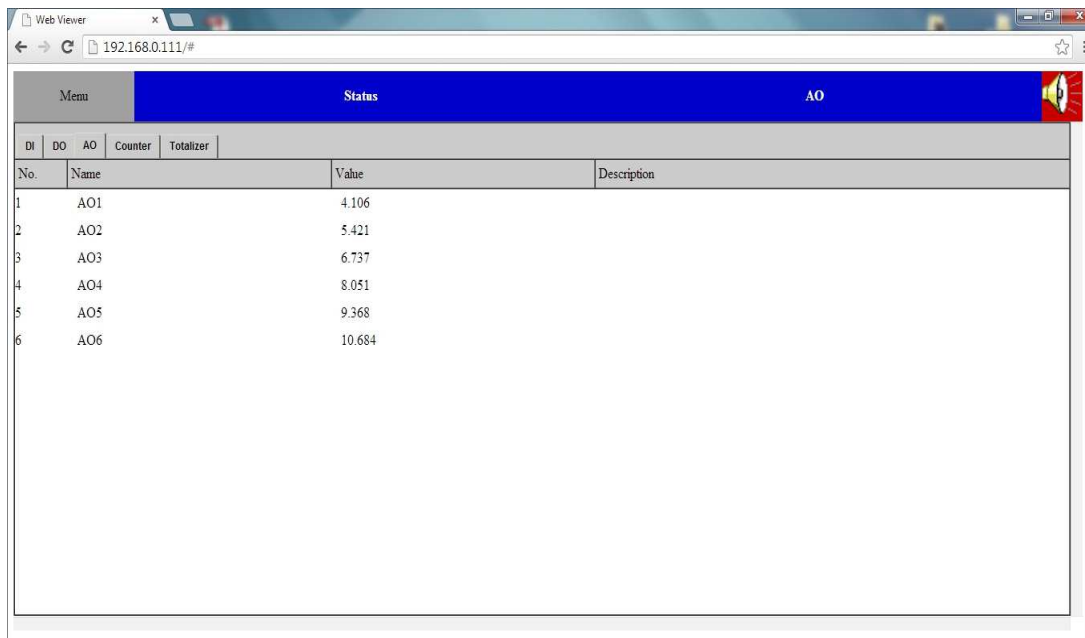

DI	DO	AO	Counter	Totalizer
No.	Name			
1	AO1			
2	AO2			
3	AO3			
4	AO4			
5	AO5			
6	AO6			

No.	Name	Value	Description
1	AO1	4.106	
2	AO2	5.421	
3	AO3	6.737	
4	AO4	8.051	
5	AO5	9.368	
6	AO6	10.684	

By pressing “Counters”, you can view the status of the counters

Menu		Status		Counter	
DI	DO	AO	Counter	Totalizer	
No.	Name	Value		Description	
1	Counter9	0			
2	Counter1	0			
3	Counter2	0			
4	Counter3	0			
5	Counter4	0			
6	Counter5	0			
7	Counter6	0			
8	Counter7	0			
9	Counter8	0			

By pressing “Totalizers” you can view the status of the totalizers.

Menu		Status		Totalizer	
DI	DO	AO	Counter	Totalizer	
No.	Name	Value		Description	
1	Totalizer1	0.000			
2	Totalizer2	5.064e+5			
3	Totalizer3	1.347e+5			
4	Totalizer4	2.765e+5			
5	Totalizer5	5.656e+5			
6	Totalizer6	5.433e+5			
7	Totalizer7	5.559e+4			
8	Totalizer8	5.464e+4			