

IP800-Series

Insertion Paddlewheel
Flow Sensor Instructions



The logo for Seametrics, featuring a blue swoosh above the word "Seametrics" in a bold, black, sans-serif font.



General Information

General InformationPage 3
 Features.....Page 3
 SpecificationsPage 4

Installation

Fitting Installation.....Page 5
 Meter InstallationPage 5
 Straight Pipe RecommendationsPage 6
 Full Pipe Recommendations.....Page 7

Connections

OverviewPage 8
 FT430Page 8
 FT440Page 9
 FT450Page 9
 FT4XX Sensus Tranceiver ConnectionsPage 9

Operation and Maintenance

Minimum FlowPage 10
 Flow Range TablePage 10
 Calibration (“K-Factor”).....Page 10
 Field CalibrationPage 10
 Rotor ReplacementPage 11
 Signal TroubleshootingPage 11
 Sensor Replacement.....Page 11
 Parts ListPage 12

Troubleshooting

ProblemsPage 13
 Probable Causes.....Page 13
 Things To Try.....Page 13

Warranty

Seametrics Limited WarrantyPage 14

The **IP800-Series** are impeller (or “paddlewheel”) insertion meters designed for use with a wide variety of liquids in pipe sizes 1/2" to 8". Sensors are available in brass, 316 stainless steel, PVC, and polypropylene. Bodies are machined from a solid rod for maximum precision. High-quality jewel bearings and nickel-bound tungsten carbide shafts are used for extreme low friction and long life.

The rotation of the rotor is detected by a non-drag Hall-effect sensor. Output is a current-sinking pulse, which can be sent long distances (up to 2,000 feet) without a transmitter. This signal can be connected directly to PLC's, counters, and computer cards, as well as a variety of Seametrics controls and displays.

Seametrics IP meters are ideal for chemical proportioning applications. For rate and total display, a modular system of electronics can be installed directly on the flow sensor

or mounted remotely. The FT430 (externally powered with pulse), FT440 (loop powered), and FT450 (battery powered) all provide digital rate and total displays, as well as a programmable pulse; the FT440 also provides a 4-20 mA analog output. Electronic modules can be wall- or meter-mounted.

The IP800-Series require special fittings that ensure correct depth placement in the pipe. Fittings come in a variety of materials for compatibility with specific applications. Tee fittings are individually wet-calibrated at the factory and marked with the K-factor (pulses per gallon). Saddle fittings must be field-installed on the pipe and do not come wet-calibrated. K-factors for saddles are based on factory-testing.

Features

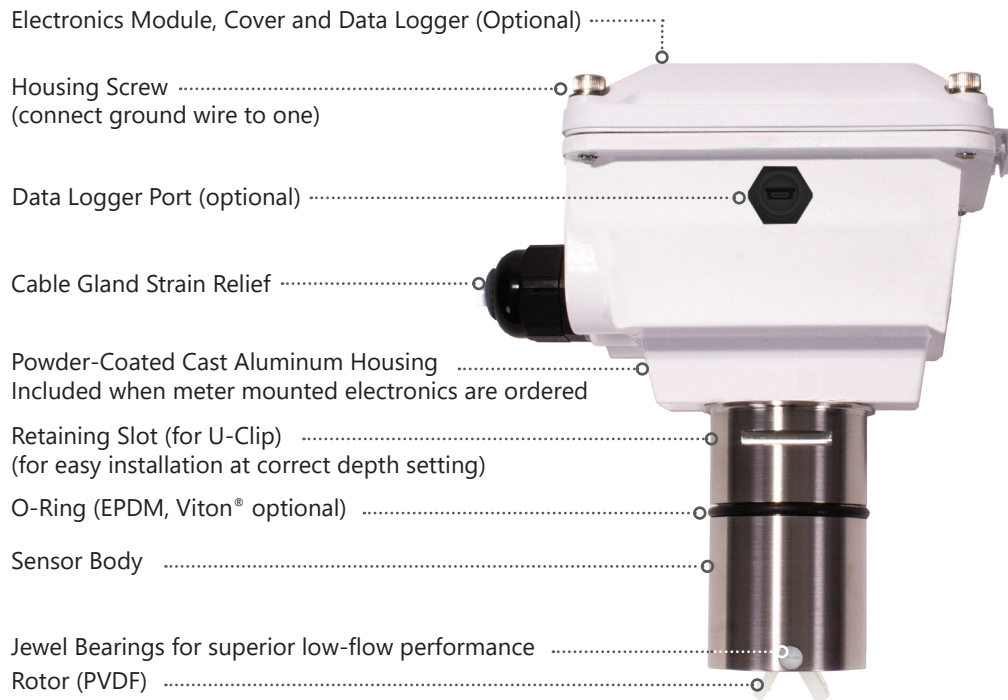

High Pressure Tee Fitting



Specifications*

Pipe Size	1/2" to 8"		
Power	Low Power: 6-36 Vdc/< 2 mA	Micropowered (-04 Option): 3.1-16 Vdc/60 µA @ 3.6 Vdc	
Sensor	Low Power: Digital Magneto-resistive	Micropowered (-04 Option): Giant Magneto-resistance (GMR)	
Materials	Optional Housing	Powder-coated cast aluminum	
	Sensor Body	Brass, 316 Stainless Steel, PVC, or Polypropylene	
	O-ring	EPDM (Viton® optional)	
	Rotor	PVDF (Kynar®)	
	Shaft	Kynar® /Tungsten Carbide (Kynar® /Ceramic or Kynar®/Silicon Carbide optional)	
	Bearings	Ruby jewel	
Maximum	Brass	316 Stainless Steel	PVC or Polypropylene (See Pressure vs. Temp. Chart)
	Pressure	200 psi (13.8 bar)	200 psi (13.8 bar)
	High Pressure	Not available	400 psi (27.6 bar)
	Temperature	200° F (93° C)	200° F (93° C)
Temperature			130° F (54.4° C)
Flow Velocity	0.3 to 30 ft/sec (0.09 to 9.14 m/sec)		
Accuracy	± 1.5% of full scale		
Output Transistor Maximum Current Sinking	150mA (low power version only)		
Cable	#22 AWG 3-con, 18' (5.5m); 2,000' (609.6m) maximum cable run Note: 50' (15m) maximum for battery powered or micropowered versions.		
Environmental	See meter mounted electronics specification for rating		
Regulatory	CE Mark		

*Specifications subject to change • Please consult our website for current data (www.seametrics.com).
Kynar is a registered trademark of Arkema, Inc., Viton is a registered trademark of DuPont Corporation.



Caution: These flow sensors are not recommended for installation downstream of a boiler feedwater pump where installation fault may expose the flow sensor to boiler pressure and temperature. Maximum recommended temperature is 130°F (54.4°C), Plastic, 200°F (93°C), Metal.

Fitting Installation

The IP800-Series are fixed-depth meters that must be used with matched fittings appropriate to the application and pipe size. This ensures that the flow sensor is installed at the correct insertion depth to measure the average flow velocity of the stream.

Straight pipe of at least 10 diameters upstream and five diameters downstream of the meter is strongly recommended for proper accuracy. This is necessary because the shape of the velocity profile changes as the rate increases around an elbow; placing the meter too near the elbow causes a distorted reading. Additional straight run may be needed under specific adverse circumstances (see next page).

If you can't provide enough straight run to smooth out the velocity profile, some decrease in accuracy may result. This does not mean the meter's reading is meaningless, however. In some applications (e.g., control system, valve operation) a repeatable reading may be more important than a highly accurate one.

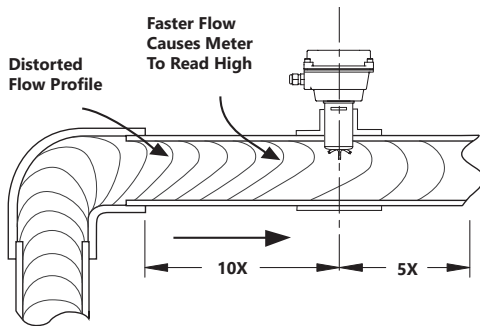

Stainless steel and brass fittings have female pipe threads, requiring the appropriate male threaded fittings. Saddle fittings require a hole to be cut in the pipe (recommended hole size is 1-3/4"). Before cutting into the pipe, observe the drawing below to choose your meter orientation.

A PVC fitting is usually installed by solvent welding. PVC tees are supplied with some upstream straight pipe, less than the recommended straight pipe requirements. It is not advisable to connect directly to the end of these fittings with a flow disturbing device (valve, elbow), but rather add straight pipe to the end of these fittings to meet the straight pipe requirements for your application.

Immersion

The IP800 Series standard sensors are not designed for continuous underwater operation. If this is a possibility, as in a flooded vault, a unit modified for immersion should be specified (Option -40), for temporary immersion.

Meter Installation

After the meter fitting is installed in the pipeline, the meter can be installed in the fitting. Press the meter into the fitting as far as it will go. Retain the meter in place by inserting the U-clip. The clip can be installed from either side. It may be necessary to rotate the probe back and forth slightly to start the clip into the slots on the probe. Slide the clip in as far as it will go.



Caution: These flow sensors are not recommended for installation downstream of the boiler feedwater pump where installation fault may expose the flow sensor to boiler pressure and temperature. Maximum recommended temperature is 130°F (54.4°C), plastic, 200°F (93°C), metal.

Horizontal (3 o'clock or 9 o'clock position) is the preferred installation orientation, since it improves low-flow performance and avoids problems with trapped air and sediment. (See Orienting the Meter diagram below.) Bottom (6 o'clock) and top (12 o'clock) installations are acceptable if required by the piping layout.

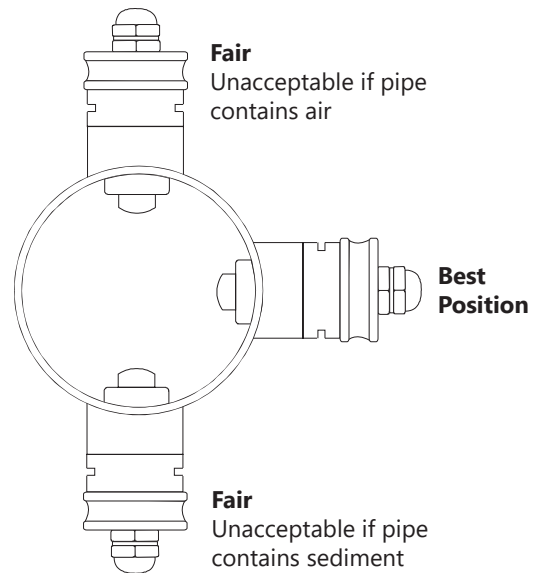

Orienting the Meter



Caution: Never remove the U-clip retainer when the pipe is under pressure. Always remove pressure from the pipe before you attempt to remove the meter. Removal under pressure may result in damage or serious injury.

Straight Pipe Recommendations (X = diameter)

Reduced Pipe

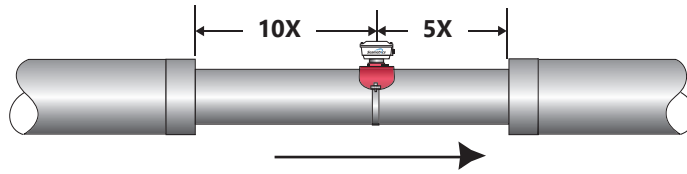

Two Elbows In Plane

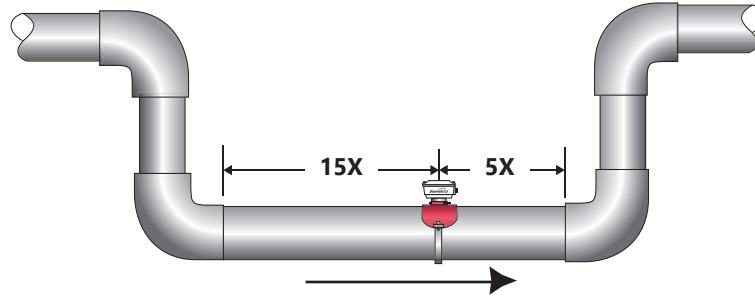

Two Elbows, Out Of Plane

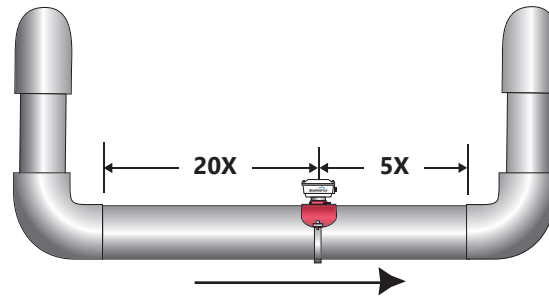

Expanded Pipe

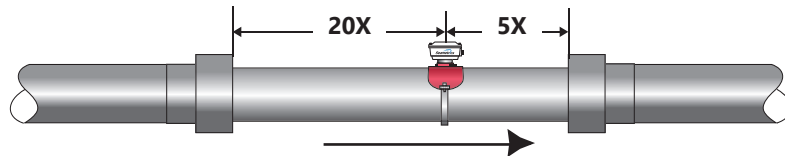

Spiral Flow

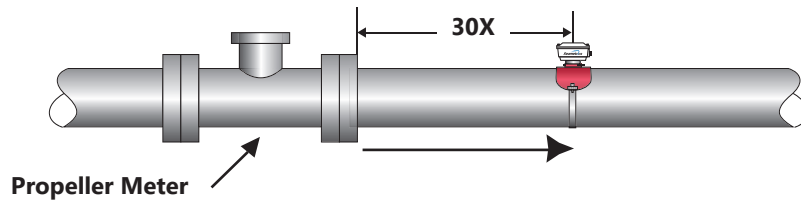

Swirling Flow

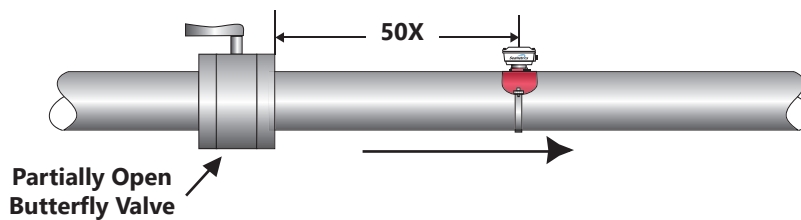

Full Pipe Recommendations

Possible Problem

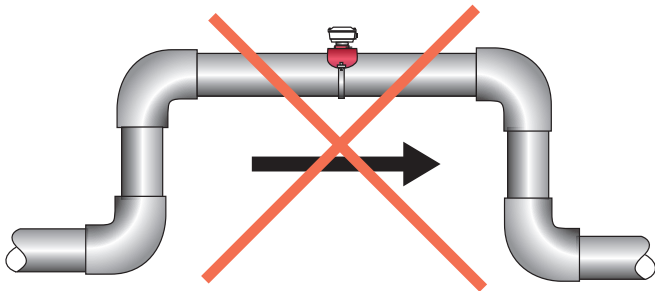

Allows air pockets to form at sensor

Better Installation

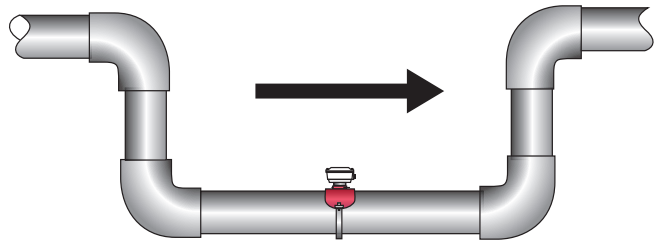

Ensures full pipe

Possible Problem

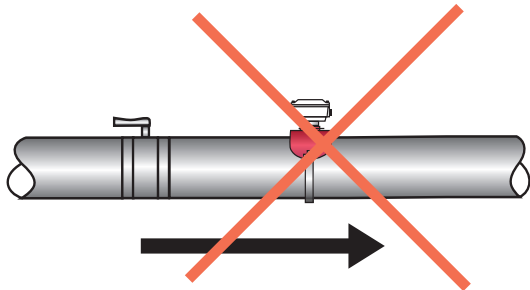

Post-valve cavitation can create air pocket

Better Installation

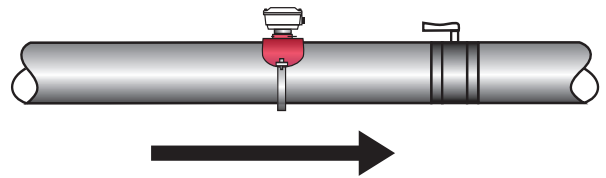

Keeps pipe full at sensor

Possible Problem

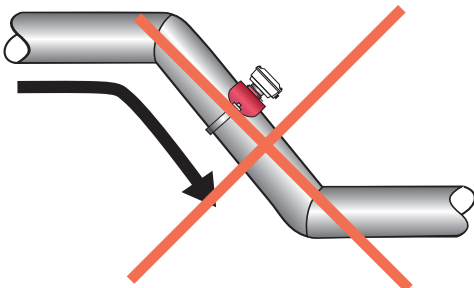

Air can be trapped

Better Installation

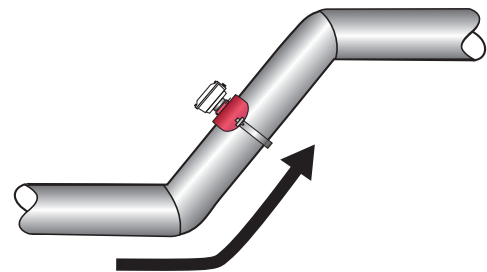

Allows air to bleed off

Possible Problem

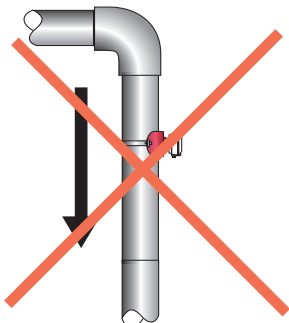

Air can be trapped

Better Installation

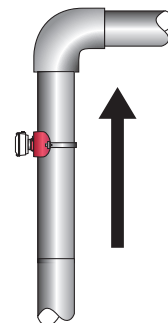

Allows air to bleed off

Sensors are supplied with 18 ft. (5.5m) of cable. For sensors with no additional electronics, see diagram for color coding of connections. For sensors with on-board electronics, see the manual accompanying the electronic module.

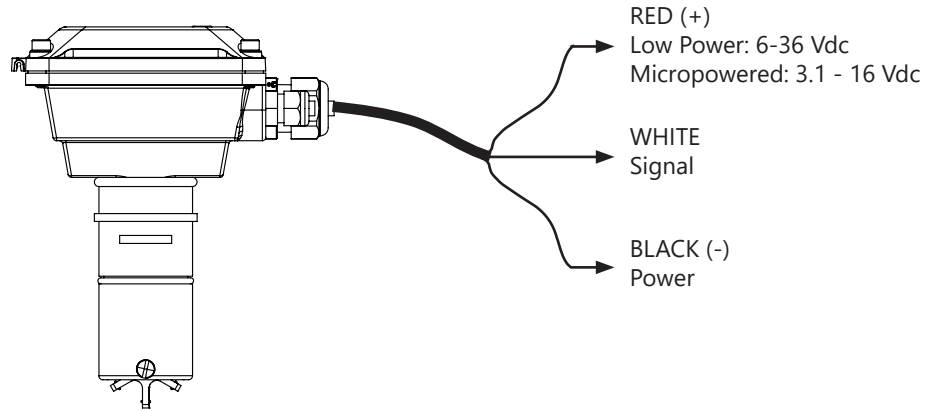

FT430

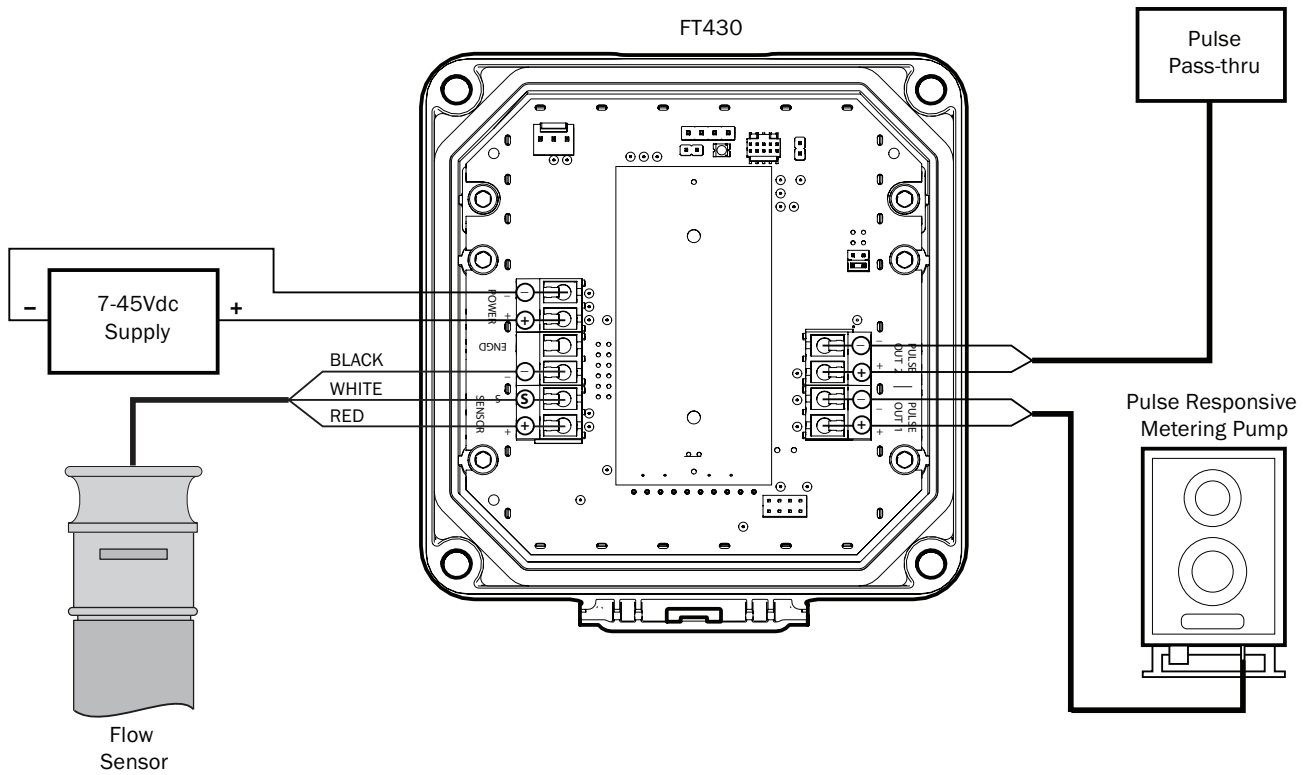

FT440

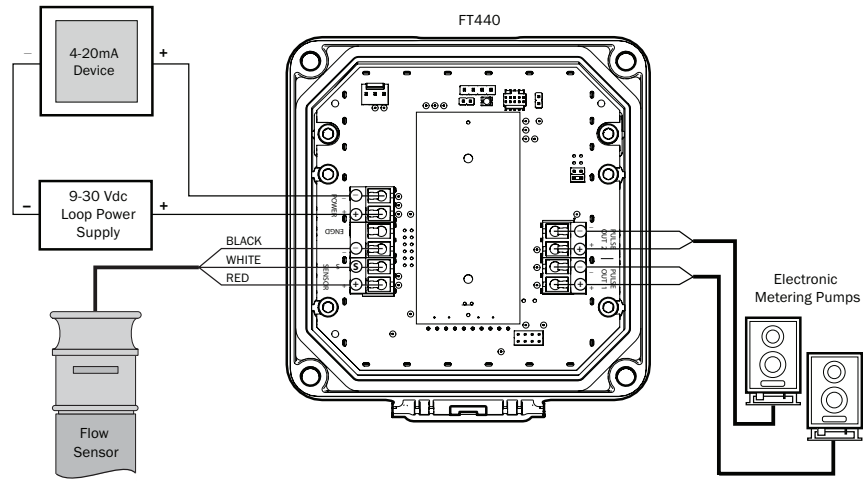

FT450

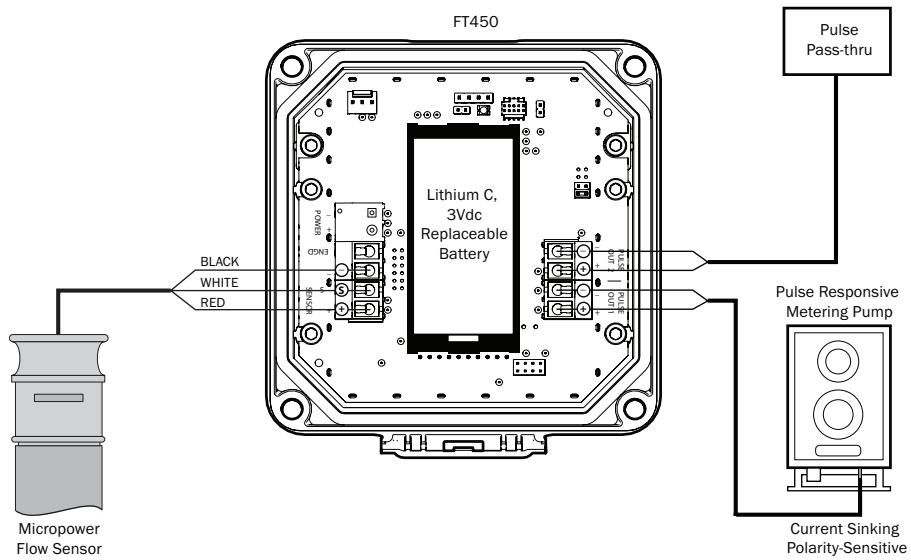

FT4XX Sensus Tranceiver Connections

FT4XX Equipped with Sensus Board (Side View)

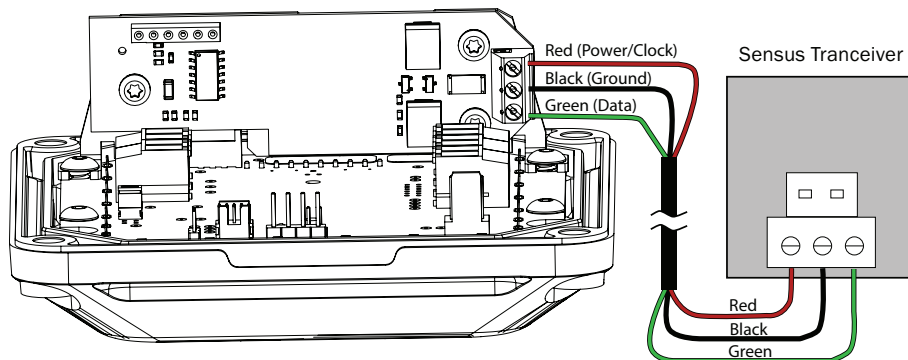

NOTE: A Sensus 2m (6 ft) output cable is prewired to the Seametrics product at the factory. Longer cables are optional.

Calibration ("K-factor")

The K-factor represents the number of pulses per gallon the meter produces during a flow test. This number must be entered into your electronic control to make it read properly. If the IP800-Series meter is ordered with a **tee fitting**, it is factory-calibrated in the fitting and the K-factor is indicated on the side (see below).

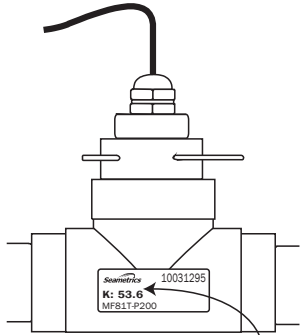

Find Your K-Factor Here

If a **saddle** or **weld-type** fitting has been ordered, use the K-factor calculator at the bottom of the **seametrics.com** home page to determine the K-factor. In PVC, however, it is possible to order a saddle pre-installed on a standard length of pipe, and the fitting can be wet-calibrated in this case.

Field Calibration

It is possible to field-calibrate an IP800-Series flow sensor to determine an accurate K-factor in the actual installation. The reason for doing this would be to compensate for an unusual condition, for instance, applications with higher viscosity fluid (IP meters are calibrated for water use) or which lack adequate straight pipe ahead of the meter. Field Calibration procedures are described in a Technical Bulletin on our website (www.seametrics.com).

Pressure vs. Temperature (PVC/Polypro)

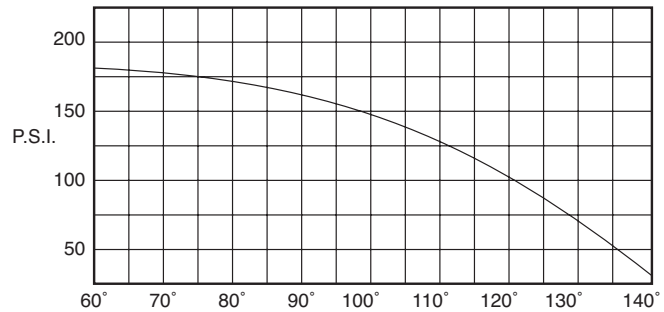

Minimum Flow

As with any other flow sensor, there is a rate below which the IP800-Series sensor cannot read. Check the flow rate table below for the minimum flow rate detectable by the sensor for a given pipe size.

Flow Range

Nominal Pipe Size	½"	¾"	1"	1½"	2"	3"	4"	6"	8"
Min GPM	0.28	0.5	0.8	1.9	3.1	6.9	12	27	46.8
Min LPM	1.06	1.89	3.03	7.2	11.7	26.1	45	102	177
Max GPM	28	50	80	190	314	691	1190	2700	4680
Max LPM	106	189	302	719	1188	2615	4504	10221	17716



Caution: Never remove the u-clip retainer when the pipe is under pressure. Always remove pressure from the pipe before attempting to remove the meter. Removal under pressure may result in damage or serious injury.

Rotor Replacement

It is unusual for a rotor to require replacement due to damage sustained in normal service. More commonly, the meter is dropped while it is out of the pipe. Another reason for rotor replacement is shaft wear after long service. Rotors are easily field-replaced.

To install a rotor, follow these steps:

1. Unscrew the threaded bearing housings to expose the shaft ends. If bearings are being replaced, back them completely out.
2. Remove the rotor. Put the new rotor in its place.
3. Thread in one bearing housing part way, then the other. Take care to start the end of the shaft into the bearing hole before tightening further.
4. Screw in bearing housings until they bottom.
Note: Do not use excessive force.
5. Check for free spin. Blowing lightly on the rotor should result in it spinning rapidly and coasting to a smooth stop.



Signal Troubleshooting

The flow sensor has only one moving part, the rotor. If this is turning properly and there is no signal, the magnetic sensor is not operating properly. To check the signal, apply 12 Vdc power to the red (+) and black (-) leads. Set a multimeter to voltage reading. Put the positive multimeter lead on the red wire and the negative lead on the white wire. Slowly turn the rotor. Voltage reading should swing between +12 Volts and 0 Volts as the rotor turns. If it does not, the solid-state magnetic sensor is not working properly. Checking for continuity is not a useful test of these sensors.

Sensor Replacement

It is very unusual for a sensor to require replacement in normal use. The primary cause of sensor failure is overvoltage (inadvertent connection of high voltage, for example) or incorrect polarity on hookup. The sensor is replaced by removing the strain relief, then threading out the sensor retainer plug. Remove the entire sensor capsule by pulling on the cable. The new sensor capsule can then be installed. Replace the retainer plug, and then replace and tighten the strain relief.

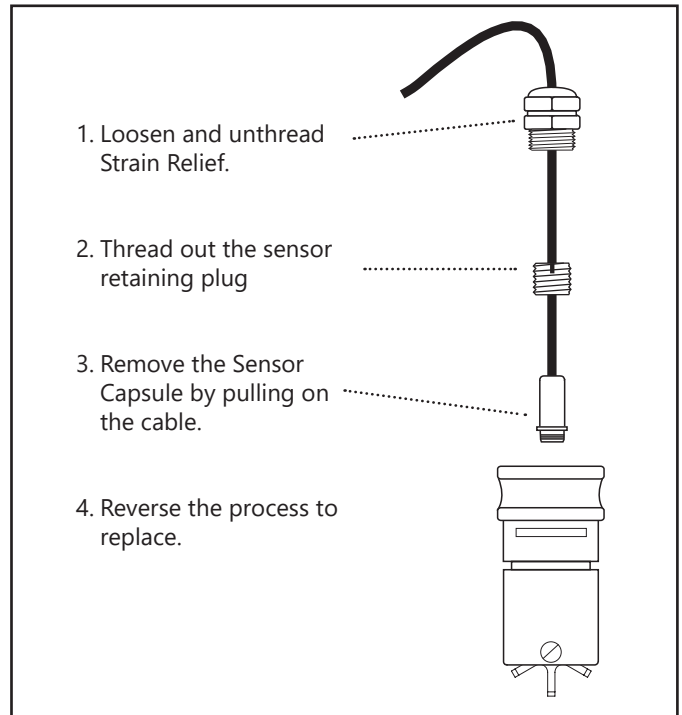

IP800-Series Parts List

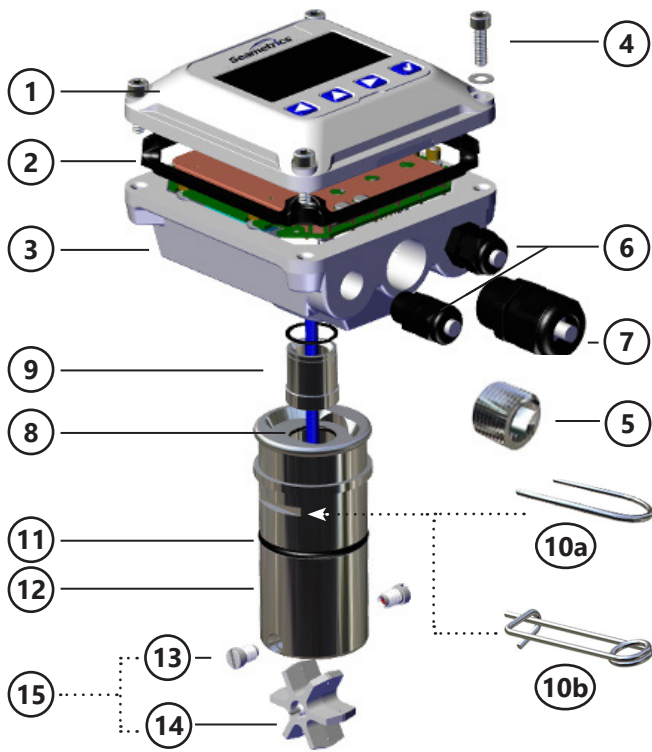

IP800 Series Parts		
1	Upper housing/ electronics	Contact service representative for your specific model
2	Housing gasket/seal	102025
3	Lower housing	Not field replaceable
4	Housing screw/washer kit (4 each)	100414
5	Plug, steel (battery units)	100360
6	Strain relief kit, small (includes 2)	100364
7	Strain relief kit, large (includes 1) (externally powered units)	101850
8	Sensor pickup	100508 (Micropower, gray cable, FT450) 100419 (Standard, blue cable, FT430/440)
9	Sensor retaining screw	100298
10a	U-clip, retainer	100154
10b	High pressure retaining clip (requires 2)	101776
11	O-ring	100264 (EPDM)
12	Body	See distributor
13	Bearings (includes 2)	103315
14	Rotor with shaft	Order Rotor Repair Kit
15	Rotor repair kit (#13 & #14 above)	100317 (Kynar®/tungsten carbide) 100043 (Kynar®/ceramic) 100556 (Kynar®/silicone carbide)

Problem	Probable Cause	Things to Try...
<p>No signal after installation</p>	<p>Insufficient flow</p>	<p>Consult Flow Rate Chart Reduce pipe size or use different sensor</p>
	<p>Bad connections to control electronics</p>	<p>Check connections at control: Red (+), Black (-), White (signal)</p>
	<p>Incompatible control</p>	<p>Use 6-36 Vdc power supply - for low power Use 3.1-16 Vdc power supply - for micropowered Add pull up resistor, if using current-sourcing device</p>
	<p>Damaged or missing rotor</p>	<p>Remove flow sensor from fitting and check for free spinning; replace rotor</p>
<p>Inaccurate metering</p>	<p>Not enough straight pipe between meter and severe flow disturbance</p>	<p>Move meter away from flow disturbance or field calibrate</p>
	<p>Wrong K-Factor entered</p>	<p>Check fitting for K-Factor, check indicator to see if it is entered properly ("Set K" on FT430, FT440, FT450, or FT520)</p>
	<p>Magnetic sensor failing to pick up each blade</p>	<p>Remove flow sensor from pipe. If indicator is FT430, FT440, FT450, or FT520, set K to 1.00, turn rotor slowly by hand, indicator should count each blade; replace sensor</p>
	<p>Wrong time units on flow indicator</p>	<p>If using FT430, FT440, or FT520, check left side of display (sec, min, hr, day); change to desired unit</p>

The limited warranty set forth below is given by Seametrics, with respect to Seametrics brand products purchased in the United States of America.

Seametrics warrants that products manufactured by Seametrics, when delivered to you in new condition in their original containers and properly installed, shall be free from defects in material and workmanship. **Seametrics products are warranted against defects for a minimum period of two (2) years from date of installation, unless otherwise specified, with proof of install date. If no proof of install date can be provided, warranty period will be two (2) years from date of shipment from Seametrics, as defined on Seametrics' invoice.** Seametrics' obligation under this warranty shall be limited to replacing or repairing the part or parts, or, at Seametrics' option, the products, which prove defective in material or workmanship. The following are the terms of Seametrics' limited warranty:

- a. Buyer must give Seametrics prompt notice of any defect or failure and satisfactory proof thereof.
- b. Any defective part or parts must be returned to Seametrics' factory or to an authorized service center for inspection.
- c. Buyer will prepay all freight charges to return any products to Seametrics' factory, or another repair facility, as designated by Seametrics.
- d. Defective products, or parts thereof, which are returned to Seametrics and proved to be defective upon inspection, will be repaired to factory specifications.
- e. Seametrics will deliver repaired products or replacements for defective products to the buyer (ground freight prepaid) to the destination provided in the original order.
- f. Products returned to Seametrics for which Seametrics provides replacement under this warranty shall become the property of Seametrics.
- g. This limited warranty covers all defects encountered in normal use of Seametrics products, and does not apply to the following cases:
 - i. Loss of or damage to Seametrics product due to abuse, mishandling, or improper packaging by buyer
 - ii. Failure to follow operating, maintenance, or environmental instructions prescribed in Seametrics' instruction manual
 - iii. Products not used for their intended purpose
 - iv. Alterations to the product, purposeful or accidental
 - v. Electrical current fluctuations
 - vi. Corrosion due to aggressive materials not approved for your specific product
 - vii. Mishandling, or misapplication of Seametrics products
 - viii. Products or parts that are typically consumed during normal operation
 - ix. Use of parts or supplies (other than those sold by Seametrics) which cause damage to the products, or cause abnormally frequent service calls or service problems
- h. A new warranty period will be established for repaired products, or products replaced during the original warranty period.
- i. In the event that equipment is altered or repaired by the buyer without prior written approval by Seametrics, all warranties are void. Damage caused by equipment or accessories not manufactured by Seametrics may void the product's warranty.
- j. SOFTWARE: The Seller grants the user a non-exclusive license to use Seametrics' software, according to the following limitations and conditions:
 - i. The user may install the software on one or more desktop or laptop computers.
 - ii. All title and intellectual rights to the software are owned by Seametrics.
 - iii. No copies may be made or distributed except as described above.
 - iv. The user may not modify or reverse-engineer the software.

THE FOREGOING WARRANTY IS IN LIEU OF ALL OTHER WARRANTIES, WHETHER ORAL, WRITTEN, EXPRESSED, IMPLIED OR STATUTORY. NO IMPLIED WARRANTY, INCLUDING ANY IMPLIED WARRANTY OF MERCHANTABILITY OR FITNESS FOR A PARTICULAR PURPOSE, APPLIED TO THE PRODUCTS AFTER THE APPLICABLE PERIOD OF THE EXPRESS LIMITED WARRANTY STATED ABOVE, AND NO OTHER EXPRESS WARRANTY OR GUARANTY, EXCEPT AS MENTIONED ABOVE, GIVEN BY ANY PERSON OR ENTITY WITH RESPECT TO THE PRODUCTS, SHALL BIND SEAMETRICS. SEAMETRICS SHALL NOT BE LIABLE FOR LOSS OF REVENUES, OR PROFITS, OR INCONVENIENCES, EXPENSE FOR SUBSTITUTE EQUIPMENT OR SERVICE, STORAGE CHARGES, LOSS OF DATA, OR ANY OTHER SPECIAL, INCIDENTAL, OR CONSEQUENTIAL DAMAGE CAUSED BY THE USE OR MISUSE OF, OR INABILITY TO USE THE PRODUCTS, REGARDLESS OF THE LEGAL THEORY ON WHICH THE CLAIM IS BASED, AND EVEN IF SEAMETRICS HAS BEEN ADVISED OF THE POSSIBILITY OF SUCH DAMAGES. IN NO EVENT SHALL RECOVERY OF ANY KIND AGAINST SEAMETRICS BE GREATER IN AMOUNT THAN THE PURCHASE PRICE OF THE PRODUCT SOLD BY SEAMETRICS AND CAUSING THE ALLEGED DAMAGE. WITHOUT LIMITING THE FOREGOING, YOU ASSUME ALL RISK OF LIABILITY FOR LOSS, DAMAGE, OR INJURY TO YOU AND YOUR PROPERTY AND TO OTHERS AND THEIR PROPERTY ARISING OUT OF USE OR MISUSE OF, OR INABILITY TO USE THE PRODUCTS NOT CAUSED DIRECTLY BY THE NEGLIGENCE OF SEAMETRICS.

SOME STATES DO NOT ALLOW LIMITATIONS ON THE DURATION OF AN IMPLIED WARRANTY, SO THE ABOVE LIMITATIONS MAY NOT APPLY TO YOU. SIMILARLY, SOME STATES DO NOT ALLOW THE EXCLUSION OR LIMITATIONS OF CONSEQUENTIAL DAMAGE, SO THE ABOVE LIMITATION OR EXCLUSION MAY NOT APPLY TO YOU. THIS LIMITED WARRANTY GIVES YOU SPECIFIC LEGAL RIGHTS; HOWEVER, YOU MAY ALSO HAVE OTHER RIGHTS WHICH MAY VARY FROM STATE TO STATE.

