



ALSONIC-FX2
Transit Time Ultrasonic Flowmeter

OPERATING MANUAL



Notice

Thank you for choosing the ALSONIC-FX2 ultrasonic flow meter from SmartMeasurement. Please read this instruction manual carefully prior to using the instrument to avoid the damage to the flow meter or improper use.



Warning

May cause injury.



Attention

May damage the flow meter.



Contents

- 1. Product Overview 5
 - 1.1. Background 5
 - 1.2. Features 5
 - 1.3. Flow measurement principle of operation 5
 - 1.4. Specifications 6
- 2. Initial power-up 8
 - 2.2. Initial power-up 8
 - 2.3. Keypad Functions 9
- 3. Quick start 10
 - 3.1. Basic settings 10
 - 3.2. Measurement Site Selection 11
- 4. Transducer Installation 12
 - 4.1. Transducer Installation 12
 - 4.2. Transducer Mounting Inspection 13
- 5. Operating Instructions 15
 - 5.1. System Normal Identification 15
 - 5.2. Low Flow Cutoff Value 15
 - 5.3. Zero Settings 15
 - 5.4. Scale Factor 15
 - 5.5. System Lock 15
 - 5.6. 4~20mA Current Loop Output 15
 - 5.7. Frequency Output 15
 - 5.8. Totalizer Pulse Output 16
 - 5.9. Alarm Programming 16
 - 5.10. 4~20mA Analog Output Calibration 17
 - 5.11. SD Card Operation 17
- 6. Windows Display Definitions 18
 - 6.1. Windows Display Codes 18
 - 6.2. Display Definitions 19
- 7. Error Diagnostics 32
 - 7.1. Table 1. Error Codes and Solutions (during operation) 32
 - 7.2. Frequently Asked Questions and Answers 33
- 8. Appendix 1 – Serial Interface Network Use and Communications Protocol 34
 - 8.1. Overview 34
 - 8.2. Serial port definitions 34
 - 8.3. Direct connection via RS232 to the host device 35



84.	Communications protocol and use.....	35
8.4.1.	HL Protocol	35
8.4.2.	MODBUS-I Communication Protocol.....	37
9.	Appendix 2 - Flow Application Data.....	42
9.1.	Sonic Velocities for Various Commonly Used Materials.....	42

1. Product Overview

1.1. Background

SmartMeasurement's ALSONIC-FX2 Transit Time Ultrasonic Flow Meter represents the next generation of flow measurement technology. The ALSONIC-FX2 employs proven ultrasonic transit-time flow measurement technology in conjunction with a user-friendly microprocessor-based display module which enables it to accurately and reliably calculate instantaneous and total flow, along with an optional function to calculate BTU/energy consumption.

This manual provides all of the necessary details for installation and use of the fixed location, wall-mount version of the ALSONIC-FX2. Proper application and installation will ensure reliable, maintenance-free long-term operation of this device. Please review the manual thoroughly prior to installation.

1.2. Features

- Linearity: 0.5%, Repeatability: 0.2%, Accuracy: $\pm 1\%$ of reading
- Non-invasive measuring technique creates no pressure loss and has no measuring mechanism to seize or jam
- User-friendly design; easy to operate
- Several types of transducers available to accommodate pipe sizes ranging from 1" to 48" (25 to 1200 mm)
- Low voltage, multi-pulse flow measuring technology improves accuracy, reliability and longevity
- Powerful data-logging function records daily or monthly totalizer data from the prior 64 days or 64 months
- 32-bit microprocessor allows for extremely precise measurement resolution of 0.04 ns
- Built-in batch control function

1.3. Flow measurement principle of operation

The transit-time ultrasonic flow measuring technique employed by the ALSONIC-FX2 is designed to measure the fluid velocity of a liquid within a closed conduit. The non-contacting type transducers clamp onto the outside of the pipe, which provides numerous benefits including non-fouling operation and low-cost installation.

The ALSONIC-FX2 utilizes two transducers that function as both ultrasonic transmitters and receivers. The transducers are clamped on the outside of a closed pipe at a specific distance from each other. The transducers can be mounted in any one of three different ways; the V-method where the acoustic signal traverses the pipe twice, the W-method where the sound traverses the pipe four times, or in Z-method where the transducers are mounted on opposite sides of the pipe and the sound crosses the pipe only once. This selection of the mounting method depends on pipe and liquid characteristics. The flow meter operates by alternately transmitting and receiving a frequency modulated burst of acoustic energy between the two transducers and measuring the transit time that it takes for sound to travel between the two transducers. The difference in the measured transit time is directly proportional to the velocity of the liquid in the pipe, as indicated by the following formula:

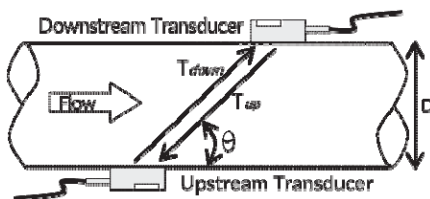

$$V = \frac{MD}{\sin 2\theta} \times \frac{\Delta T}{T_{up} \cdot T_{down}}$$

Where:

- V = Fluid Velocity
- M = Ultrasonic frequency of reflection
- D = Pipe Diameter
- θ = The angle between the ultrasonic signal and the flow
- T_{up} = Transit time in the forward direction
- T_{down} = Transit time in the reverse direction
- $\Delta T = T_{up} - T_{down}$



1.4. Specifications

Performance specifications	
Measuring Range	0.98 ft/s~32 ft/s (0.3 m/s~10 m/s)
Accuracy	±1% of reading (0.3~5 m/s); ±5% of reading (0.1~10 m/s)
Repeatability	0.2%
Pipe Sizes	1"~32"(25 mm~800 mm); 20"~48" (500 mm~1200 mm)
Functional Specifications	
Output	Analog output: 0/4~20 mA, (max load 750 Ω); Frequency/Pulse output: 0~9999 Hz, OCT (min. and max. frequency are user-configurable); Relay output: max. frequency 1Hz (400 mA @ 125 V _{AC} or 2A @ 30 V _{DC})
Digital Communication Interface	RS232 / RS485
SD Card (Optional)	Maximum number of records: 512 days w/ recording interval: 1~3600s
Power Supply	10~36 V _{DC}
Keypad	16 key membrane keypad
Display	256*128 dot-matrix, backlit LCD
Temperature	Transmitter: -4°F~140°F (-20°C ~60°C). Transducer: -22°F~176°F (-30°C ~80°C), standard; Optional -22 °F ~230°F (-30~+110°C)
Humidity	Up to 0~99% RH, non-condensing
Physical specifications	
Transmitter	Polycarbonate/ABS Plastic, IP65
Transducer	Encapsulated design Standard / Maximum cable length: 16ft / 984ft (5m / 300 m).
Weight	6.3" x 9.0" x 11.0", 7 lbs. (16*23*28cm, 3.2kg)

2. Connections

2.1. Wiring Connections

2.1.1. Power supply

The ALSONIC-FX2 is available as a DC powered or AC line powered device. The factory default power supply is DC and requires 10~36V_{DC}/1A max while the optional AC powered version requires 85~264V_{AC} 50/60 Hz. Close attention should be paid to which version of the product has been ordered prior to wiring the meter and all electrical connections should be made in strict accordance with local electrical codes as well as the diagrams provided in this manual.

2.1.2. Wiring Diagram

Once the display module has been securely mounted, the meter wiring connections may be made. All electrical connections are made via terminal blocks; to access the terminal blocks, unfasten the screws the enclosure's front cover and open the hinged cover. Refer to the diagram and table below for specific connections:

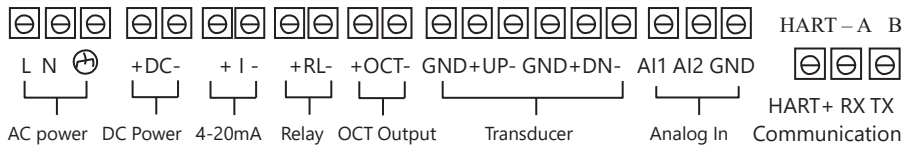

Terminal	Description
L	85~264 V _{AC} live connection
N	85~264 V _{AC} neutral connection
⊕	Earth ground
DC+	DC Power; 10~36V _{DC} positive
DC-	DC Power; 10~36V _{DC} negative
RL OUT+	Relay output; normally open
RL OUT-	
OCT OUT+	Open Collector Transistor output
OCT OUT-	
GND	Upstream sensor ground (Black)
UP+	Upstream sensor positive (Brown)
UP-	Upstream sensor negative (Blue)
GND	Downstream sensor ground (Black)
DN+	Downstream sensor positive (Brown)
DN-	Downstream sensor negative (Blue)
I +	0/4~20mA output positive
I -	0/4~20mA output negative

Terminal	Description
AI1	Analog input (Energy meter only)
AI2	
GND	Signal ground
TX	RS232 Output
RX	
GND	
A	RS485 Output
B	
IN1+	Supply water temperature sensor positive (Energy meter only)
IN1-	Supply water temperature sensor negative (Energy meter only)
GND	Supply water temperature sensor ground (Energy meter only)
IN2+	Return water temperature sensor positive (Energy meter only)
IN2-	Return water temperature sensor negative (Energy meter only)
GND	Return water temperature sensor ground (Energy meter only)



Warning

De-power the meter prior to making any electrical connections. Verify proper grounding prior to initial power-up. The AC and DC power inputs **MAY NOT** be used simultaneously – connect only one at a time in order to prevent damage to the meter's internal circuitry.

2.2. Initial power-up



At the moment of initial power-up, the flowmeter's firmware will automatically load the most recent set of parameters that were programmed into the meter. If transducer installation is performed while the system is powered up, gain adjustment can be monitored in menu window M04. Once the "**R" code is displayed on the upper right corner of the screen, the system will then enter into normal measurement mode automatically.

If the instrument is being used for the first time, or if it is being moved to a new location with different pipe characteristics, the new pipe / installation site parameters must be entered. Any user-entered operation parameters input into the programming menus will be automatically saved until the next time they are modified.

Once all of the parameters have been entered correctly and transducer spacing has been correctly set, the meter will recalculate automatically based on the settings that have been input and provide accurate readings. The instrument will always calculate flow and update the analog and digital outputs regardless of whether the normal measurement mode screen or the programming menu screen is displayed on the LCD.

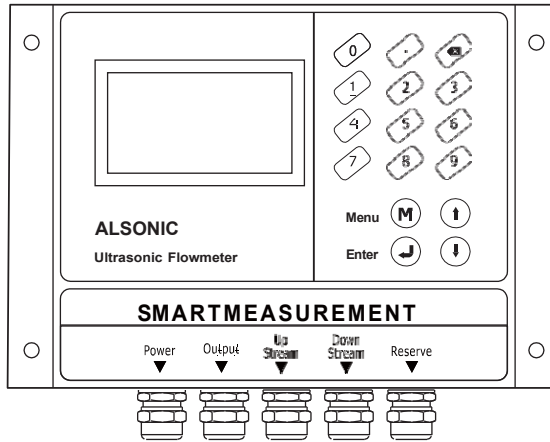
2.3. Keypad Functions



The  ~  keys and the decimal point key are used to enter numeric parameter values and menu numbers.

The  backspace / delete key is used to move the cursor one position to the left or to navigate to the previous menu.

The  key is used to increment numeric values or to advance to the next available menu.

The  key is used to decrement numeric values or to return to the previous menu.

The  key functions as the ENTER key when entering numeric values or making menu selections.



The  Menu Select key is used to access the programming menu. Pressing this key, followed by the two-digit menu number will navigate directly to the specified menu.





The SD memory card slot is an optional feature.

2.4. Keypad Operation



The ALSONIC-FX2 makes use of a window-style menu structure for navigating the programming menu. Individual windows may contain user-entered process / pipe parameters, raw measurements, or the results of a calculation that the instrument is making. In certain windows, the operator may input and change parameters while others may be read-only. Each menu window number, or ID code, will correspond to a specific instrument function which will be defined later in this manual. For example, menu window M10 is the window that is used to input the pipe outside diameter, while menu window M14 is a read-only menu that displays the result of the calculation that indicates the mounting spacing between the transducers.

In order to navigate to a specific window, press the Menu  key followed by the 2-digit window ID code. For example, to view or input a new value for the pipe outside diameter parameter, the "Menu", "1", and "0" keys for window ID code 10. The  and  keys may be used to select individual parameters within a menu window or to navigate to the next or the previous menu window in sequence.

For menu windows that contain user-adjustable parameters, press the Enter  key after navigating to the window, use the numeric keypad to modify the value, and then press the Enter  key again to confirm the entry.



Attention

Typically, pressing the  key followed by a menu window number will grant access to the parameter setting menu. If pressing the Menu  key repeatedly does not grant access, this indicates that the system is locked by a password. To unlock, navigate directly to menu window M54 and enter the factory default password or the current password issued by the system owner/administrator.

3. Quick start

3.1. Basic settings

Example: PVC pipe with 200mm outer diameter & 4mm wall thickness and no liner, the measured fluid media is clean potable water. The parameters would be entered as follows:

Step1. Pipe Size Settings

Navigate to menu window M10 and use the numeric keypad to enter the pipe outside diameter and wall thickness in the units of measure displayed.

Press the Enter key to confirm the entry.

M10 Pipe settings *R		
Size	M.	
OD	200.00	mm
thk	4.0	mm

Step 3. Water Temperature

Navigate to menu window M12 and use the numeric keypad to enter the normal operating temperature of the water. The value should be somewhere in the range of 0~80 °C.

Press the Enter key to confirm the entry.

M12 Medium *R		
WTMP	20	(°C)

Step 5. Transducer Mounting Method

Use the \uparrow key to navigate within menu window M13 until the transducer mounting method is highlighted. For this pipe size, the V-method would be the appropriate choice.

Press the Enter key to confirm the entry.

M13 Pipe settings *R		
Type	Method	Mode
Option	0.V	

Step 7. Display Measurement Results

Once the transducers have been installed onto the pipe and spaced correctly, the instrument will start providing readings. Navigate to menu window M01 to display the measured flow rate.

M01 INSTL Spacing *R		
Flow	Vel.	
100.2		m ³ /hr

Step2. Pipe Material

Use the \downarrow key to navigate the menu choices for pipe material until "PVC" is displayed on the LCD screen.

Press the Enter key to confirm the entry.

M10 Pipe settings *R		
Size	M.	
M.	0.PVC	
Other	3200	m/s

Step 4. Transducer Type

Navigate to menu window M13 and use the \downarrow and the \uparrow keys to select the proper transducer type. In this example, the standard clamp-on D-type would be the appropriate choice for a 200 mm O.D. pipe.

Press the Enter key to confirm the entry.

M13 Medium *R		
Type	Method	Mode
Option	0.Clamp-On	(°C)

Step 6. Transducer Installation Spacing

After all of the parameters from Steps 1 through 5 have been entered correctly, the ALSONIC-FX2 will calculate the correct face-to-face distance between the transducers. Navigate to menu window M14 to view the result of the calculation and then space the transducers accordingly on the pipe.

M14 INSTL Spacing *R		
Value	151.5	mm

3.2. Measurement Site Selection

The first step in the installation process is to select an ideal location to mount the transducers in order to obtain the most accurate measurement possible. To identify an optimal location, a basic knowledge of plumbing and piping systems is essential.

The key characteristic of an optimal location is a sufficient length of straight pipe full of liquid on both the upstream and downstream sides of the sensor. The piping can be in either a vertical or horizontal orientation. The illustration below shows the upstream and downstream straight pipe requirements for some commonly encountered installation situations. Other key considerations for site selection include:

- Install the transducers on the longest length of straight pipe available. Make sure that the straight run of pipe is situated in a location where it will always be completely full of liquid.
- When installing the transducers on horizontal pipe runs, make certain to situate the transducers at the 9 o'clock and 3 o'clock radial position of the pipe. Avoid the 6 and 12 o'clock positions in order to prevent signal attenuation caused by sediment at the bottom of the pipe, cavitation, or bubbles at the top of the pipe.
- Make sure that the temperature in the selected installation location does not exceed the transducers' maximum temperature rating.
- Take precautions to avoid the effects of pipe fouling. Select a straight length of relatively newer pipe for the installation location. If this is not possible, consider the fouling thickness as part of the liner for more accurate results.
- Make certain that the pipe material is sound-conducting.

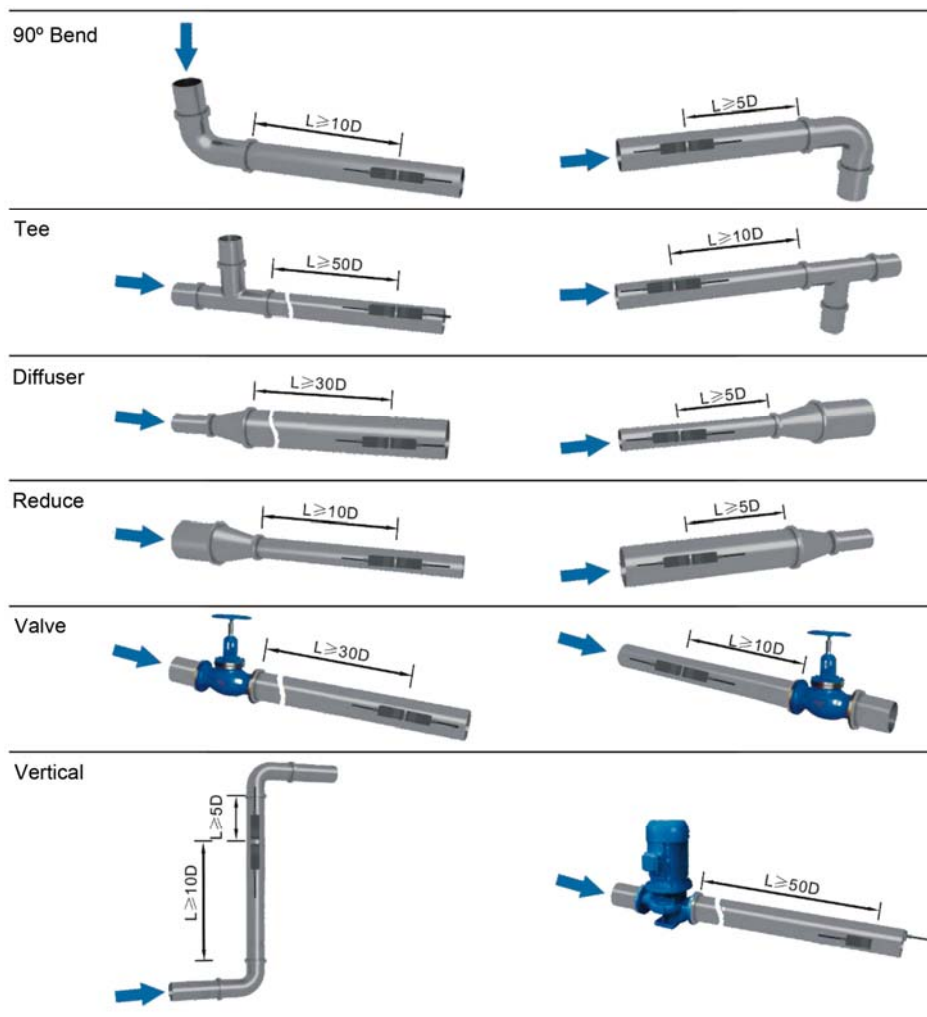

4.1. Transducer Installation

The ALSONIC-FX2 transducers employ piezoelectric crystals both for transmitting and receiving ultrasonic signals through the wall of the process piping. The velocity measurement is obtained by measuring the difference in traveling time between the two ultrasonic signals. Since this difference is very small, the spacing and the alignment of the transducers are critical factors to the accuracy of the measurement and to the performance of the system. Meticulous care should be taken when installing the transducers.

The following considerations should be observed during installation of the transducers:

- ①. Clean any rust and debris from the pipe surface. For best results, polishing the pipe with a sander is strongly recommended.
- ②. Identify an ideal location where the straight pipe length is sufficient, and where the pipes are in a suitable condition, i.e., newer pipes free of rust and/or other contamination
- ③. Apply adequate coupling compound to the spot where the transducers are to be installed and make sure that there is no gap between the pipe surface and the transducers.
- ④. To avoid gas bubbles inside the upper portion of the pipe, the transducers should be installed horizontally on the side of the pipe.

Note: The two transducers should be mounted at the pipe's centerline on horizontal pipes (3 and 9 o'clock positions).

Make certain that the transducer mounting direction is aligned with the flow profile.

During installation, double-check that there is adequate silicone coupling compound applied to the pipe so that there are no air gaps or particles between the transducer and the pipe wall.

If the transducers cannot be mounted on a horizontal pipe run due to a lack of sufficient straight pipe or some other constraint, it may become necessary to mount the transducers on a vertical or an angled pipe run. In this situation, make certain that the location will be full of liquid at all times.

4.1.1. Transducer Spacing

The spacing variable shown in menu window M14 contains the distance between the two transducers. The actual transducer spacing must be as close as possible to the value displayed in menu window M14.

4.1.2. Transducer Mounting Methods

There are two mounting methods available for the ALSONIC-FX2; the V-method and the Z-method. Where and when to use each is discussed in detail in sections 4.1.3 and 4.1.4 below.

4.1.3. V Method

The V-method configuration is the most commonly used for applications with pipe inner diameters ranging from 15 mm to 200 mm (½ inch to 8 inch). This configuration is also referred to as reflective mode.

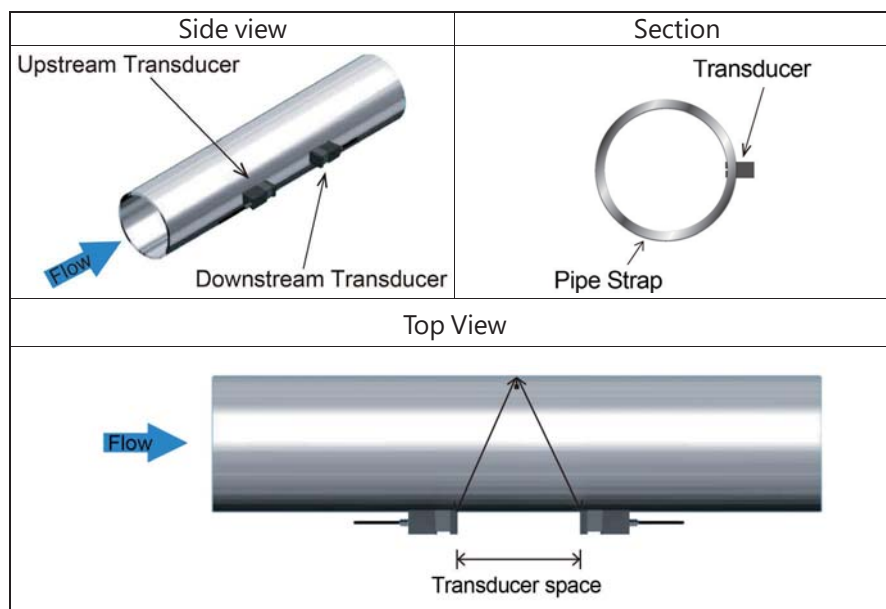

4.1.4. Z Method

The Z method installation, also referred to as the direct method, provides for lower attenuation losses than a signal transmitted via the V method. This is because the Z method utilizes a directly transmitted (rather than reflected) signal which traverses the pipe diameter only once. The Z method is commonly used with pipe diameters ranging from 100mm to 5000mm (4 inch to 200 inch).

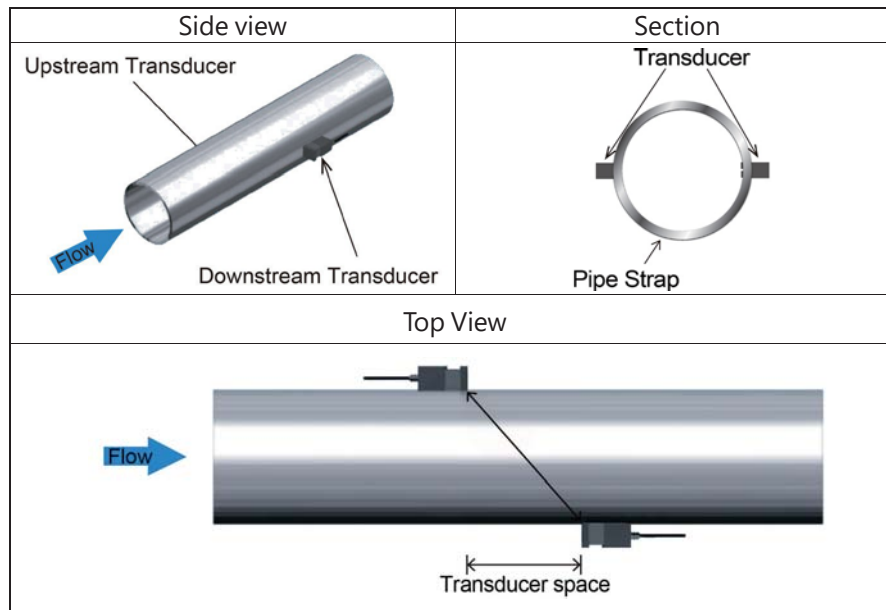

4.2. Transducer Mounting Inspection

The quality of the mounting condition directly influences the calculated flow value accuracy and overall long-term reliability of the instrument. In most instances, the only things required to ensure the quality of the transducer mounting are a clean pipe surface and a sufficient amount of the sonic coupling compound between the face of the transducer and the outside pipe wall.

The ALSONIC-FX2's installation verification features allow several parameters directly related to the quality of the transducer mounting to be checked. These parameters include the receiving signal strength, the signal quality Q value, the traveling time difference between the two signals, the estimated liquid speed, the measured traveling time of each signal, and the calculated traveling time ratio. Making use of this feature will ensure optimal measurement accuracy and longer service time of the instrument.

4.2.1. Signal Strength

The Signal Strength value displayed in menu window M04 indicates the amplitude of the received ultrasonic signals with a 3-digit number. A value of [00.0] means there is no signal detected while [99.9] indicates to the maximum possible signal strength.

The instrument will work well if the signal strength values are above 50.0; however, stronger signal strength values should always be pursued as stronger signals provide better results. The following methods are recommended for obtaining stronger signals:

- (1) Relocate to a more favorable location if the existing location does not provide a stable and reliable flow reading, or if the signal strength is lower than 60.0.
- (2) Try polishing the outside surface of the pipe or applying more coupling compound in order to increase the signal strength.
- (3) Adjust the transducers both vertically and horizontally while looking at the variance in signal strength, and then stop at the highest value. After the highest value is obtained, check the transducer spacing to make sure that it agrees with the value that is displayed in window M14.

4.2.2. Signal Quality (Q value)

Signal quality is indicated by the Q value displayed in menu window M04. A higher Q value is indicative of a higher Signal-to-Noise Ratio (SNR), and by extension, a higher degree of accuracy. Under normal pipe conditions, the Q value should range from 60.0-90.0; the higher the better.

Causes for a lower Q value could be:

- (1) Interference from other nearby instruments and devices, such as a large transformer or variable frequency drive. Relocating the flow meter to an area that is further away from the source of interference should alleviate the problem.
- (2) Poor sonic coupling of the transducers to the pipe. Try to apply more coupling compound or clean the pipe surface in order to

correct the problem.

- (3) An abnormality in the pipe wall. Relocation may correct the problem.

4.2.3. Total Time and Delta Time

Total Time and Delta Time, which are displayed in menu window M04, are additional indicators of the condition of the installation. The measurement calculations made by the flow meter are directly related to these two parameters. When Delta Time fluctuates widely, the calculated flow and the measured velocity will fluctuate accordingly. This is symptomatic of poor signal quality which may be the result of poor pipe-installation conditions, inadequate transducer installation or incorrect parameter input.

Generally, the Delta Time fluctuation should be less than $\pm 20\%$, unless a very low velocity or a very small pipe is being measured.

4.2.4. Transit Time Ratio

Transit Time Ratio is also displayed in menu window M04. A This ratio is used to check the quality of the transducer installation. If the pipe parameters are entered correctly and the transducers are installed properly, then the value for this ratio should be in the range of 100 ± 3 . If the displayed value is outside of this range, then the following should be checked:

- (1) Verify that the pipe parameters have been entered correctly.
- (2) Verify that the actual spacing of the transducers and the value displayed in menu window M14 are the same.
- (3) Make sure that the transducers are installed in the proper orientation.
- (4) Check to see if the pipe is out-of-round (non-circular) or if there is excessive fouling inside of the pipe.

Installation Precautions

- ①. Pipe parameters must be entered accurately and correctly. Incorrect pipe parameters may lead to instrument malfunction or to incorrect calculations being provided by the instrument.
- ②. Always make certain to apply sufficient coupling compounds pipe surface. Insufficient coupling compound is the top cause of poor signal quality. Make use on menu window M04 to guarantee a good installation - while monitoring the signal strength and Q value, move the transducers slowly around the mounting site until the strongest signal and maximum Q value are obtained.
- ③. Double-check the transducer spacing to verify that it is in agreement with the value displayed in menu window M14 and that the transducers are mounted at the pipe's centerline.
- ④. Pay special attention to applications involving seamed piping as these types of pipes always are irregular. If the signal strength is always displayed as 0.00, this means that there is no signal detected. Thus, it is necessary to check that the parameters (including all of the pipe parameters) have been entered accurately. Check to be sure the transducer mounting method has been selected properly, the pipe is not worn-out, and the liner is not too thick. Make sure there is indeed fluid in the pipe and that the transducer is not too close to a valve or an elbow, and that there are no air bubbles present in the fluid.
- ⑤. Avoid installation locations where excessive electrical noise is present.

5. Operating Instructions

5.1. System Normal Identification

If an "R" is displayed on the instrument's LCD screen, this indicates that the system is operating normally. A letter "D" on the LCD screen also indicates normal operation, but that the system is adjusting the signal gain prior to measurement. Only when the adjustment takes too long will the status be changed to abnormal.

If a letter "E" appears on the LCD, this indicates that no signal is being detected. Verify that the transducer wiring connections are correct and that they have been installed onto the pipe correctly. For further information, please refer to the Error Diagnostics section of this manual.

5.2. Low Flow Cutoff Value

Menu window M21 is the Low Flow Cutoff Value. This window is for the low flow rate cutoff. Measured flow rates that are below the value entered in this window will be displayed as zero on the LCD and will not be registered in the totalizers. The analog and pulse outputs will also be zeroed any time the flow rate falls below the value entered into this field.

5.3. Zero Settings

There are a variety of reasons that the flowmeter may indicate a non-zero reading when there is known to be no flow moving through the pipe, such as EMI-RFI interference or ambient acoustic noise being transmitted along the pipeline. If the meter is showing a flow rate even though there is known to be a full pipe with no liquid moving through it, menu window M22 can be used to manually zero the instrument.

First, make absolutely certain that the pipe is full and that there is no fluid moving in the pipe (check for leaks along the pipeline, verify that there are no leaky valves downstream of the transducer installation). Next, navigate to menu window M22, and press the Enter key once to highlight the word "Option". Next, press the Enter key again to move the cursor to "0.No" in the middle column of the screen and then use the  key to change the selection to "1.Yes" and press the Enter key. The display will then indicate "waiting" for a period of time and then show the "success" after the zeroing process is complete. Once the process has been completed, navigate back to menu M01 and verify that a zero reading is shown on the display.

5.4. Scale Factor

The scale factor is the ratio between the 'actual flow rate' and the value indicated by the instrument. It can be determined by industry standard calibration techniques. For example, when a traceable calibration standard installed in-line with the ALSONIC-FX2 is indicating 2.00 GPM and the ALSONIC-FX2 is indicating 1.98 GPM, the scale factor would be $2/1.98$, or 1.01.

Menu window M26 can be used to enter a scale factor that will compensate for these inaccuracies, but it is important not to adjust the value in this menu window unless the scale factor has been obtained by using industry-standard calibration methods that make use of traceable instruments. To change the scale factor, navigate to menu window M26, press the Enter key to highlight the word "Value", then press the Enter key again to move the cursor to the factory-default value of 1.000, and then use the numeric keypad to enter the new scale factor.

5.5. System Lock

The system lock is used to prevent unauthorized changes to the values programmed into the instrument's menu windows. Menu window M54 contains the for system lock; to turn this feature on, navigate to menu window M54, press the Enter key to highlight the word "Option", then press the Enter key again to move the cursor over to the factory default setting of "C. Not Used", and then enter the factory default password of 2901.

At this point, the system lock may be turned on and a new password will need to be specified. Record the password and keep it in a safe place.

5.6. 4~20mA Current Loop Output

The ALSONIC-FX2 comes with an analog current output that may be configured either as a 0–20 mA or as a 4-20 mA output. The analog output is configured in menu window M32. Within menu M32, the output 0-20/4-20 mA type may be selected, the full scale flow rate corresponding to the 20 mA output may be set, and certain predetermined milliamp outputs may be generated for testing purposes.

5.7. Frequency Output

The ALSONIC-FX2 is provided with a frequency output transmitter function. The output frequency is connected to the frequency receiving device via the meter's Open Collector Transistor (OCT) output, as shown in the wiring diagram below. All of the menu settings required to set up the instrument for frequency output are made in menu window M33. To configure the frequency output, the first step after navigating to menu window 33 is to set the Option setting in the **Mode** tab to "0. Flow Rate". Next, both the high

and low output frequencies must be entered in the **FRange** setting within the **Mode** tab. The low frequency is typically 0 Hz, but may be adjusted to other frequencies if required. The high frequency may be up to 10 kHz. Finally, the flow range that will correspond to the range of frequencies entered in the **Mode** tab must be entered in the **Range** tab. The flow rate corresponding to the low frequency will be entered in the **LowerL** setting and the flow rate corresponding to the high frequency will be entered in the **UpperL** setting. Consider the following example:

A 50-2000 Hz frequency output corresponding to flow rates ranging from 0 to 500 GPM:

- In the **Option** setting within the **Mode** tab, select "**0. Flow Rate**".
- In the **FRange** setting within the **Mode** tab, enter a value of **50** to the left of the dash mark and a value of **2000** in the space to the right of the dash mark.
- In the **LowerL** setting within the **Range** tab, enter a value of **0.0** GPM.
- In the **UpperL** setting within the **Range** tab, enter a value of **500.0** GPM.

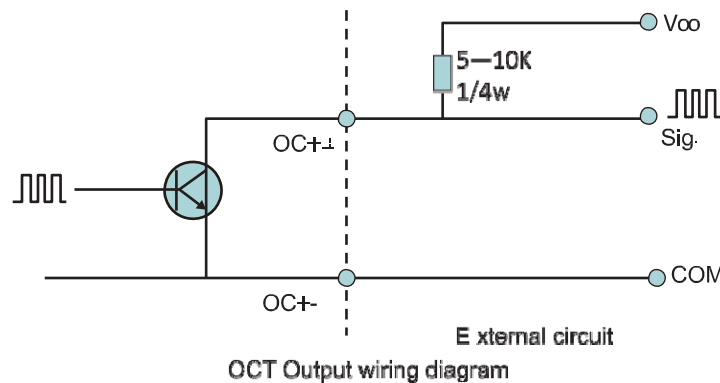

5.8. Totalizer Pulse Output

The ALSONIC-FX2 may be configured to provide a totalizer impulse output. With this type of signal, one positive-going pulse with a 200 millisecond duration will be generated each time a predetermined amount of liquid passes the transducers and is added to the totalizer. The totalizer pulse output can be transmitted through either the OCT or the relay output. Adjustments to certain sections of menu windows M33, M34, and M41 may be required in order to configure the instrument to provide a totalizer impulse output. If the impulse output is to be directed to the OCT output, then the **Option** setting in the **Mode** tab of M33 must be set to either "1.POS Total", "2.NEG Total", or "3.Neg Total". If the output is to be directed through the relay, the **Option** setting in the **Mode** tab of M34 must be set to either "g.POS Total", "h.NEG Total", or "i.Neg Total".

For example, suppose that one pulse for every 10 m³ is required. In Window M41-Unit, select the totalizer flow unit "m3"; In Window M41-MULT, select the scale factor "e. x10"; In Window M34-Option, select "g. POS Total";



Attention

Make sure to select an appropriate totalizer pulse. If the totalizer pulse is too big, the output cycle will be too long; if the totalizer is too small, the relay will operate too faster, you may shorten the life of the relay, as well as skip some pulses. The totalizer is recommended to transmit within the range of 1~3 pulse per second.

5.9. Alarm Programming

The ALSONIC-FX2's relay may be programmed to signal a number of alarm conditions by using menu windows M34 and M35. The relay may be programmed to actuate based on the following conditions:

- (1) No signal detected;
- (2) Poor signal detected;
- (3) The flow meter is not ready for normal measurement;
- (4) Reverse flow is detected;
- (5) A user-set low flow alarm condition;
- (6) A user-set high flow alarm condition.

For example, to use the relay to signal an alarm condition whenever the flow rate exceeds 495 GPM or falls below 15 GPM:

- Navigate to menu window M35. In the **LowerL** setting within the **Alarm1** tab, enter a value of "**15**" GPM.
- In the **UpperL** setting within the **Alarm1** tab, enter a value of "**495**" GPM.
- Navigate to menu window M34. In the **Option** setting, select "**d. Alarm1**".



5.10.4~20mA Analog Output Calibration



Attention

Every flow meter has been 100% factory calibrated before leaving the factory and it is unnecessary to perform this procedure except when the current output value, as measured by a calibrated milli-ammeter is not identical to the value displayed in Window M32 is when the output check function is executed.

The hardware detect window must be activated prior to calibrating the analog output. The procedure is as follows:

- Connected a calibrated milliammeter to the instrument's 4-20 mA output terminals.
- Navigate to menu window M62 and enter the current password if prompted.
- Highlight the "4mA" selection and press the Enter key to highlight the "Enter to go" text. Press the Enter key once more to enable the adjustment mode and use the and keys to change the value displayed on the milliammeter until it reads 4.00 mA and then press the Enter Key.
- Highlight the "20mA" selection and press the Enter key to highlight the "Enter to go" text. Press the Enter key once more to enable the adjustment mode and use the and keys to change the value displayed on the milliammeter until it reads 20.00 mA and then press the Enter Key.

5.11. SD Card Operation

5.11.1. Specifications

Data collection interval: Any interval ranging from 1 to 3600 seconds is permissible.

Data content: Date and time, flow rate, fluid velocity, total flow, positive totalizer, negative totalizer.

Data storage format:

a=2017-11-16,16:21:12 b=+2.652471E+00 m³/h c=+9.380460E-02 m/s d=+3.520580E+02 m³ e=+3.520580E+02 m³
 f=+0.000000E+00 m³ g=+0.000000E+00 GJ/h h=+0.000000E+00 GJ i=+0.000000E+00 GJ j=+0.000000E+00°C
 k=+0.000000E+00°C File system format: FAT16. File type: plain text file (.TXT). File number: maximum 512 entries.

Up 120 bytes of data at a time may be saved. When set to save once per 5 seconds, the storage capacity over 24 hours is $120 \times 3600 / 5 \times 24 = 2073600$ bytes or ≈ 2.1 Mbytes. Therefore, a 1 Gbyte SD card capacity measured in days would be: $1024 / 2.1 = 487.6 \approx 487$ days. When the capacity of the SD card is filled, the new data will override the earliest records automatically.

5.11.2. Installing or Removing the SD card while the meter is powered on

Installing or removing the SD card while the meter is powered up is not recommended and should be avoided if possible.



Attention

Never remove the SD card from the reader while it is actively working with the data. Data should be saved and stored in a separate location, such as a PC hard disk, and then processed from that location. Processing the data directly from the SD card file location on the PC could result in loss of data if the SD card is removed while still being processed.

5.11.3. ESN

Each flow meter has a unique electronic serial number for identification stored in menu window M50. The ESN stored in this menu will match the serial number on the meter's external labeling. Additional information included in menu window M50 includes instrument type and versions.



Attention

Please refer to "6.2 Window Display Definitions" for details on menu windows not discussed in the sections above.

6. Windows Display Definitions

6.1. Windows Display Codes

	Functional Category	Menu Window Settings
M0X	Display Value and Condition *R- System Normal *E - Signal Not Detected *D- Adjusting Gain	M00 Flow Totalizer
		M01 Flow Rate
		M02 Heat (Only for energy meter)
		M03 Cool (Only for energy meter)
		M04 Status
M1X	Installation Setting	M10 Pipe Settings
		M11 Lining Settings
		M12 Liquid Settings
		M13 Transducer Settings
		M14 Installation Space
M2X	Calibration Setting	M20 Damping
		M21 Low Flow Cut off Value
		M22 Zero Point Settings
		M23 Totalizer
		M24 Temperature (Only for energy meter)
		M25 Power -off COMP
		M26 K Factor
		M27 Correction
		M28 SQA
M3X	Input and Output Settings	M30 Serial Port Parameter
		M31 AI Settings
		M32 CL Settings
		M33 OCT Settings
		M34 Relay Settings
		M35 Alarm Value Settings
		M36 Ration (Only for energy meter)
		M37 Micro SD Settings (option)
M4X	Flow Unit Opinions	M40 Toggle Units
		M41 Flow Units
		M42 Energy Units (Only for energy meter)
		M43 Temperature Units (Only for energy meter)
M5X	meter information	M50 Serial Number
		M51 Time and Date
		M52 Key Tone
		M53 Language (English- set by factory)
		M54 System Lock
		M55 System Reset
M6X	Others	M60 Date Totalizer
		M61 Running Timer
		M62 CL Adjust
		M63 RTD Adjust (Only for energy meter)
		M64 AI Adjust

NOTE: Other menu features not shown in the table above are retained for use by the manufacturer.

6.2. Display Definitions

M00

Flow Total

The Net Totalizer, Positive totalizer, and Negative Totalizer may be displayed in menu window M00. Use the \uparrow and \downarrow keys to switch between the three totalizers.

M00		Flow Total	*R
Net	POS	NEG	
123.4			E+0 m ³

M00		Flow Total	*R
Net	POS	NEG	
123.4			E+0 m ³

M01

Flow Rate

The flow rate, fluid velocity, and net totalizer are displayed in menu window M01. The second row of this menu window will alternate between flow rate, velocity, and the totalizer every 6 seconds. The Enter key may be used to stop these values from scrolling. The flow rate is always displayed in large text in the bottom row of this menu window.

M01	Flow Rate	*R
0.000		m/s
0.000		m ³ /h

M02

Heat Rate

Menu window M02 is visible only on units that were ordered with the BTU/energy measurement option. This window displays the BTU/heat total, the BTU/ heat rate, the inlet/supply water temperature and the supply/return temperature difference. The second row of this menu window will alternate between supply temperature, temperature difference, and the BTU/heat rate every 6 seconds. The Enter key may be used to stop these values from scrolling.

Menu window	x 0.01(E-2)
x 0.1(E-1)	x 1(E+0)
x 10(E+1)	x 100(E+2)
x 1000(E+3)	x 10000(E+4)

M02		Heat	*R
100.2		KW	
234.5			E+0 GJ

M02		Heat	*R
30.0	2.0	(°C)	
234.5			E+0 GJ

M03

Menu window M03 is visible only on units that were ordered with the BTU/energy measurement option. This window displays the BTU/cooling total, the BTU/ cooling rate, the inlet/supply water temperature and the supply/return temperature difference. The second row of this menu window will alternate between supply temperature, temperature difference, and the BTU/cooling rate every 6 seconds. The Enter key may be used to stop these values from scrolling.

Cool Rate

Menu window M03 is visible only on units that were ordered with the BTU/energy measurement option. This window displays the BTU/cooling total, the BTU/ cooling rate, the inlet/supply water temperature and the supply/return temperature difference. The second row of this menu window will alternate between supply temperature, temperature difference, and the BTU/cooling rate every 6 seconds. The Enter key may be used to stop these values from scrolling.

Menu	x 0.01(E-2)
x 0.1(E-1)	x 1(E+0)
x 10(E+1)	x 100(E+2)
x 1000(E+3)	x 10000(E+4)

M03		Cool	*R
100.2		KW	
201.6			E+0 GJ

M03		Cool	*R
9.0	-2.0	(°C)	
234.5			E+0 GJ

M04

Status

A variety of parameters related to the meter's operating status may be viewed in menu window M04. The upstream and downstream signal strength, the signal quality Q, the measured sonic velocity of the flowing fluid media, the transit time ratio diagnostic, the total transit time and the delta (difference between) of the upstream-to-downstream and the downstream-to-upstream transit times may all be

viewed in this window.

Under the **Signal** tab of this menu window, two rows are displayed that show the signal strength and the signal Q value for the upstream and downstream transducers, respectively. The signal strength is measured on a 0-100% scale with a higher number indicating a stronger signal. A minimum value of 50 is required for the signal strength in order to get good readings; ideally this value should be above 60. The signal quality, or Q value that is displayed for each transducer is also measured on a relative scale of 0 to 100 with 0 being poorest and 100 being the best quality. Ideally, the Q value should be greater than 60.

The **Sound** tab of menu window M04 displays two diagnostic parameters. The row labeled "Vel." displays the measured sonic velocity of the flowing media in units of m/s. For example, potable water at ambient temperature has a sonic velocity of approximately 1500 m/s. If there is supposed to be water inside of the pipe but a value that is significantly different from 1500 m/s is displayed here, this could indicate that the process conditions need to be checked, or that the transducers are mis-spaced. The row labeled "Ratio" displays the transit time ratio diagnostic, measured as a %. This is the ratio between the actual measured transmit time and the calculated transmit time based on the operating parameters programmed into the meter. Normally the ratio should be 100±3%. If the displayed value is outside of this range, it usually indicates that the operating parameters have not been entered correctly, in particular the sonic velocity of the fluid and parameters related to transducer installation.

Finally, the tab labeled Time provides raw time measurements from the transducers. The row labeled "Total" indicates the amount of time for the sonic wave to travel from the upstream to the downstream transducer and then back again, measured in microseconds (µs). The row labeled Delta displays the difference between the amount of time it takes for the ultrasonic pulse to travel from the upstream to the downstream and the downstream to the upstream transducer in units of nanoseconds (ns). The volumetric flow rate reading that the instrument provides is calculated by using these two readings. The Delta time is the best indication that the instrument is running steadily. Normally the fluctuation in the ratio of the delta time should be less than 20%. If wider fluctuations are seen, the transducers' installation should be checked and the parameter programing should be verified.

M04			status	*R
Signal	Sound	Time		
UP	DN	Q		
0.0	0.0	0		

M04			status	*R
Signal	Sound	Time		
Vel.	1509	m/s		
Ratio	99%			

M04			status	*R
Signal	Sound	Time		
Total	0.0	µs		
Delta	0.0	ns		

M10

Pipe settings

User-entered parameters related to the pipe characteristics are entered in menu window M10. The pipe outside diameter, wall thickness, and material are all entered via this menu window. Under the **Size** tab, the pipe outer diameter is entered on the top row. This value must range from 3/8" to 48" (10mm to 1200mm). The pipe wall thickness is entered on the bottom row of the Size tab.

Settings related to the pipe material are entered under the **M.** tab. The top row under this tab contains a number of pipe materials whose properties have been pre-programmed into the menu. If the pipe being used is any one of numbers 0~8 shown below, simply select the appropriate menu item from this list and the material selection is complete:

- | | | | |
|-----------------------|----------------------|--------------------------|--------------------------|
| 0. PVC | 1. CS (Carbon Steel) | 2. SSP (Stainless Steel) | 3. CIP (Cast Iron Pipe) |
| 4. DIP (Ductile Iron) | 5. Copper | 6. Alu. (Aluminum) | 7. ACP (Asbestos Cement) |
| | 8. FPG (Fiberglass) | 9. Other | |

If the pipe material is not one of numbers 0~8 above, then "9. Other" must be selected on the top row under the **M.** tab and the sonic velocity of the pipe material being used must be entered on the bottom row of the tab in units of m/s or ft/s.

M10			Pipe settings	*R
Size	M.			
OD	108.0	mm		
thk	4.0	mm		

M10			Pipe settings	*R
Size	M.			
OD	0.PVC			
Other	3200	m/s		

M11

Lining

Menu window M11 is used for entering the liner material and thickness. The liner thickness is entered on the top line of the size tab in units of either inches or mm. It should be noted that if the pipe is not lined and the "No Liner" menu selection is entered into the **M.** tab, any entered value for thickness in this menu window will be null and void and not considered in the flow rate calculation.

Settings related to the liner material are entered under the **M.** tab. The top row under this tab contains a number of materials whose properties have been pre-programmed into the menu. If the liner material is any one of numbers 0~10 shown below, simply select the appropriate menu item from this list and the material selection is complete:

- | | | | |
|-----------------------|---------------|---------------------|--------------|
| 0. No Liner | 1. Tar Epoxy | 2. Rubber | 3. Mortar |
| 4. PP (Polypropylene) | 5. Polystyrol | 6. PS (Polystyrene) | 7. Polyester |
| 8. PE (Polyethylene) | 9. Ebonite | 10. Teflon | 11. Other |



If the pipe material is not one of numbers 0~10 above, then "11. Other" must be selected on the top row under the **M** tab and the sonic velocity of the pipe material being used must be entered on the bottom row of the tab in units of m/s or ft/s.

M11		Lining	*R
Size	M.		
Thk.	3.0	mm	

M11		Lining	*R
Size	M.		
Option	0.	No liner	
Other	2400	m/s	

M12

Medium

The temperature of the measured water media is entered in Menu window M12 in units of °C as shown below.

M12		Medium	*R
WTMP	20		

M13

Transducer

The transducer type and the transducer mounting method are entered in menu window M13. The transducer type is entered in the **Type** tab, as illustrated below. There are a total of five choices available:

- 0. Clamp-On C
- 1. Clamp-On D
- 2. Clamp-On X
- 3. Plus-In
- 4. Clamp-In X

The transducer mounting method is entered in the **Method** tab, as shown below. There are a total of 3 choices available:

- 0. V
- 1. Z
- 2. N

M13		Transducer	*R
Type	Method	Mode	
Option	1.	Clamp-On D	

M13		Transducer	*R
Type	Method	Mode	
Option	0.	V	

M13		Transducer	*R
Type	Method	Mode	
Option	0.	Mode0	
Other	0.000		

M14

Installation space

Menu window M14 is a read-only window that displays the proper transducer spacing measured face-to-face as shown on page 11. After all of the application and piping parameters have been correctly entered into menu windows M10 through M13, the ALSONIC-FX2 will calculate the proper spacing and display it as shown below. During the transducer installation process, it is critical to space the transducers as precisely as possible according to the value displayed in this window.

M13		Transducer	*R
Value	3.15	inch	

M20

Damping

The damping factor, which is set in menu window M20, acts as a filter used to stabilize flow rate readings. If '0' is entered in window M20, that means there is no damping. A larger number will add more filtering and provide more stable readings, but will reduce response time. Values ranging from 1-999 seconds may be selected; settings ranging from 0 to 30 are most commonly used.

M20		Damping	*R
Value	1		

M21
Low Vel. Cutoff

The number displayed in window M21 is referred to as the low flow cutoff value. The flow meter will interpret any reading below this value as '0'. The LCD display will indicate a flow rate of zero and totalization will be inhibited until the measured velocity increases to a value that is above the low-flow cutoff. The meter's analog and frequency outputs will also go to zero when the measured velocity falls below this value. The default value is 0.03m/s.

The low-cutoff value does not affect the instrument's readings when the actual flow is above the low-cutoff value.

M21	Low Vel. Cutoff	*R
Value	0.03	m/s

M22
Zero Settings

Occasionally, the flow meter may display a non-zero value even though the flow in the pipe is known to be at a complete stop, or in some instances what is known as an "offset" error may be observed. There are a number of reasons that these types of situations may be observed, and when they do occur, menu window M22 offers a variety of ways to remedy them.

When a small, non-zero flow rate is shown in a pipe that is known to have no flow, the **Cutoff** tab in menu window M22 provides a way to zero the instrument. Prior to performing the zeroing, it is absolutely critical to verify that the location where the transducers are installed contains a pipe that is full of liquid and is perfectly still with no moving fluid. From the **Cutoff** tab, press the Enter key once to highlight the word "Option". Next, press the Enter key again to move the cursor to "0.No" in the middle column of the screen and then use the \uparrow key to change the selection to "1.Yes" and press the Enter key. The display will then indicate "waiting" for a period of time and then show the "success" after the zeroing process is complete.

In some instances, it be necessary to undo a manual zero bias that was performed in the **Cutoff** tab and return the instrument to it's factory default state. For instance, a user may discover that there actually was water moving through the pipe when the zeroing procedure was performed. In these cases, the **Reset** tab provides a way to undo the zeroing. From the Reset tab, press the Enter key once to highlight the word "Option". Next, press the Enter key again to move the cursor to "0.No" in the middle column of the screen and then use the \uparrow key to change the selection to "1.Yes" and press the Enter key. The display will then indicate "waiting" for a period of time and then show the "success" after the manually applied zero has been removed.

Finally, the **Offset** tab provides a way to correct observed offset errors. An example of an offset error would be when the ALSONIC-FX2 provides a reading of 250 GPM when being compared to a traceable calibration standard that indicates 240 GPM. After increasing the flow rate to 300 GPM as read by the ALSONIC-FX2, the calibration standard then indicates 290 GPM. In this example, the offset error would be +10 GPM. To remedy this type of error, navigate to the Offset tab, press the Enter key twice to modify the Value field, and then use the \uparrow and \downarrow keys to offset the reading by -10 GPM.

M22	Zero Settings	*R
Cutoff	Reset	Offset
Option	0.No	

M22	Zero Settings	*R
Cutoff	Reset	Offset
Option	0.No	

M22	Zero Settings	*R
Cutoff	Reset	Offset
Value	0.0	GPM

M23
Totalizer Options

Menu window M23 allows the user to enable or disable and also to reset each of the ALSONIC-FX2's totalizers individually. To enable or disable one or more of the instrument's totalizers, navigate to the **Switch** tab. To enable a specific totalizer, set the value in the far-right column to "0.ON". To disable a totalizer set this value to "1.OFF". Individual totalizers that may be enabled or disabled in this menu are as follows:

- | | | |
|---------------------------|---------------------------|-------------------------|
| 0.POS (Positive Flow) | 1. NEG (Negative Flow) | 2. NET (Net Total Flow) |
| 3. HEAT (Heating energy)* | 4. COOL (Cooling Energy)* | |

**Visible only on units ordered with the BTU/Energy measurement option*

To reset one specific, or all of the instrument's totalizers, navigate to the **Reset** tab. Highlight the individual totalizer, or totalizers that

are to be disabled, and then press the Enter key to reset the value(s) to zero. Individual totalizers that may be reset in this menu are as follows:

- | | | |
|---------------------------|---------------------------|----------------------------|
| 0.POS (Positive Flow) | 1. NEG (Negative Flow) | 2. NET (Net Total Flow) |
| 3. HEAT (Heating Energy)* | 4. COOL (Cooling Energy)* | 5. ALL (Reset all to zero) |

**Visible only on units ordered with the BTU/Energy measurement option*

M23		Totalizer	*R
Switch	Reset		
Flow	0.POS	0.ON	

M23		Totalizer	*R
Switch	Reset		
Flow	0.POS	m/s	

M24

Temperature

Menu window M24 is only visible on units that have been ordered with the BTU/Energy measurement option. In this menu, the type of temperature measurement devices being used, the desired temperature measurement sensitivity, and the specific heat capacity of the flowing media may be specified.

The **Source** tab is used to specify what type of temperature measuring device is being used. Two options are available; RTD type which would be connected to the meter's IN1 and IN2 RTD inputs, or analog 4-20 mA temperature sensors which would be connected to the analog inputs. To specify RTD type, select "0.RTD" on the Option line of the M24 **Source** tab. For analog-type temperature sensors, select "1.AI".

The **SSTV** tab controls the meter's temperature sensitivity setting. When the measured temperature delta is less than the value entered into this field, the BTU/energy consumption rate calculated by the meter will go to zero and the energy totalizer will not increment. To adjust the temperature sensitivity, navigate to the row labeled Value in the **SSTV** tab, use the \uparrow and \downarrow keys to adjust the setting, and then press the Enter key to confirm.

The specific heat capacity of the flowing liquid is entered in the **SHC** tab. To select the specific heat of water, select "0.CJ128" in the row under this tab labeled Option. If the media is water-glycol or some other type of thermal transfer fluid, select "1.Other" in the Option row and then use the numeric keypad to manually enter the specific heat capacity of the measured fluid into the row labeled Other.

M24		Source	*R
Source	SSTV	SHC	
Option	0.RTD		

M24		Source	*R
Source	SSTV	SHC	
Value	0.20	°C	

M24		Source	*R
Source	SSTV	SHC	
Flow	0.POS	0.ON	

M25

Power Down Correction Switch

The ALSONIC-FX2 is equipped with an option to perform an automatic power down flow correction. What this type of function does is estimate the amount of flow that passed through the pipe when power to the meter is lost. It does this by looking at the average flow rate and the time of the power loss and then measuring the amount of time the power was out and then updating the meter's totalizer accordingly. This function may be turned "ON" or "OFF" in menu window M25 as shown below.

M25		PowerOFF COMP	*R
Option	0.OFF		

M26

K Factor

Menu window M26 can be used to enter a correction, or K-factor. Use of a K-factor may be necessary if the meter is providing inaccurate readings. A K-factor is determined by installing a traceable calibration standard in line with the ALSONIC-FX2's transducers and comparing the readings provided by the instrument to the readings provided by the calibration standard. The K-factor is determined by dividing the flow rate measured by the calibration standard by the flow rate shown on the ALSONIC. Once a K-factor has been programmed into this window, all results of the flow rate calculation performed by the ALSONIC-FX-2 will be multiplied by the K-Factor. To program the K-factor, navigate the Value row in M26 and use the numeric keypad to enter the factor.

M26		K Factor	*R
Value	1.000		

M27
Correction

Menu window M27 contains three different tabs; one for entering a multi-point linear correction look-up table, one for entering a transducer delay correction, and one for adjusting the transducer power level. The transducer delay correction, which is found under the **Delay** tab, and the transducer power control, which is found under the **TPC** tab are factory-set and under normal circumstances would very rarely need to be adjusted by the end user. Always consult the factory before making any adjustments within these two menu tabs.

The linear correction look-up table is entered in the **KArray** tab. To use this function, a table of data must first be obtained by gradually increasing the flow rate through the pipeline and then recording the flow rate indicated by the ALSONIC-FX2 compared to the flow rate indicated by a traceable flow calibration standard. Up to 10 points may be recorded for use in the look-up table. To enable this function and enter the points from the data table, navigate to the **KArray** tab and then select "0.ON" on the row that is labeled Option. After the function is enabled, navigate to the row labeled Value. The data format for values entered into this row is two numeric values separated by a comma. The value on the left side of the comma is a fluid velocity measured either in units of ft/s or m/s depending on the units system set in menu window M40 and the value to the right of the comma is a correction (or "K") factor which is the ratio of the flow rate measured by the calibration standard to the flow rate reading indicated by the ALSONIC-FX2. For the first entry in the table (entry a), the lowest flow rate tested against the calibration standard should be input. Convert the flow rate to a fluid velocity and then use the numeric keypad to enter this value to the left of the comma. For the value to the right of the comma, divide the flow rate measured by the calibration standard by the flow rate displayed on the ALSONIC-FX2 and use the numeric keypad to enter the result of the calculation. This process may be repeated for up to a total of 10 data points.

M27	Correction	*R
KArray	Delay	TPC
Option	0.ON	
Value	>a 1.64 , 1.015	

M27	Correction	*R
KArray	Delay	TPC
Value	0.0	μs

****Consult factory prior to use****

M27	Correction	*R
KArray	Delay	TPC
Option	0.Auto	

****Consult factory prior to use****

M28
SQA

The ALSONIC-FX2 comes with a SQA statistical analysis tool. The feature may be enabled or disabled in the Set tab of menu window M28. The results buffer may be cleared under the Reset tab.

M28	SQA	*R
Set	Reset	
Option	0.ON	
Value	0.000	

M28	SQA	*R
Set	Reset	
Option	0.Auto	
Value	0.000	

M30
RS232/RS485

The ALSONIC-FX2 comes with a RS-232/RS-485 serial communications. The baud rate for serial communications, the slave ID, and the bit order are all set in menu window M30. The number of stop bits is 1 and the number of parity bits is 0 by default and these values may not be changed.

The baud rate and the slave ID are configured under the **Set** tab in this menu. The slave ID is entered on the row labeled ID and may be programmed for any value from 01 to 99 via the numeric keypad. The baud rate is set in the row labeled Option. The following speeds may be selected by using the **↑** and **↓** keys:

- a. 2400
- b. 4800
- c. 9600
- d. 19200
- e. 38400
- f. 56000

The bit order is set in the **Order** tab of this menu. The following four choices may be made using the **↑** and **↓** keys:

- a. 1-0:3-2
- b. 0-1:2-3
- c. 3-2:1-0
- d. 2-3:0-1

M28	RS-232/RS485	*R
Set	Order	
Option	b. 4800	None
ID	55	

M28	SQA	*R
Set	Order	
Option	a. 1-0 : 3-2	

M31
AI Setting

Menu window M31 controls the range settings for the analog inputs and also provides a feature to view the value that is presently being read by each respective input. To set the ranges, use either the **AI1** or the **AI2** tab. Both tabs have identical layouts and are programmed in the same manner. In the row labeled LowerL, use the numeric keypad to enter the value that the minimum 4 mA signal should correspond to, in units of °C. In the row labeled UpperL, use the numeric keypad to enter the value that the full-scale 20mA input signal should correspond to, in units of °C. The **Value** tab provides a means of monitoring the values that are being read in from each channel, as shown below.

M31 AI Settings *R		
AI1	AI2	Value
LowerL		0.0
UpperL		1000.0

M31 AI Settings *R		
AI1	AI2	Value
LowerL		0.0
UpperL		1000.0

M31 AI Settings *R		
AI1	AI2	Value
AI1		0.0
AI2		0.0

M32
CL Setting

Menu window M32 controls all aspects of the analog current loop's operations. Within this menu, the analog signal type may be selected, the range of values that the analog output corresponds to may be set, and the instrument may be directed to produce a simulated output at various different signal levels.

To choose the type of analog output signal, navigate to the row labeled Option under the **Mode** tab. A total of six different analog signals may be chosen by using the **↑** and **↓** keys:

Menu Item	Description of analog signal
a. 4-20 mA	4-20 mA output proportional to flow rate
b. 0-20 mA	0-20 mA output proportional to flow rate
c. 0-20 mAUart	Asynchronous data communication via 0-20 mA
d. 20-4-20 mA	For bidirectional flow, -20 mA for max reverse flow, 4 mA @ no-flow, +20mA @ max positive flow
e. 0-4-20 mA	For bidirectional flow, 0 mA for max reverse flow, 4 mA @ no-flow, +20mA @ max positive flow
f. 20-0-20 mA	For bidirectional flow, -20 mA for max reverse flow, 0 mA @ no-flow, +20mA @ max positive flow
g. 4-20mA-Vel	4-20 mA output proportional to fluid velocity

The range that the analog signal corresponds to is set in the **Range** tab of menu window M32. In the row labeled LowerL, the flow rate or velocity that corresponds to the minimum -20, 0, or 4 mA value is entered via the numeric keypad. The full-scale flow rate or fluid velocity that corresponds to 20 mA is selected in the row labeled UpperL, as shown in the illustration below.

The **Check** tab may be used to generate an analog signal at various different levels for purposes of troubleshooting the meter or simulating an input signal to a device that the ALSONIC-FX2 is connected to. In the row labeled Option, simulated signals of 0 mA, 4 mA, 8 mA, 12 mA, or 20 mA may be selected by using the **↑** and **↓** keys.

M32 CL Settings *R		
Mode	Range	Check
Option	a. 4-20 mA	

M32 CL Settings *R		
Mode	Range	Check
LowerL	0.0	m ³ /hr
UpperL	1000.0	m ³ /hr

M32 CL Settings *R		
Mode	Range	Check
Option	2. Check 8 mA	

M33
OCT Setting

Menu window M33 controls the operation of the Open Collector Transistor (OCT) output. Within this menu, the parameter that is communicated through this output is chosen, the range of frequencies that the OCT produces is set, the range of values that the frequency corresponds to may be set, and the instrument may be directed to produce a simulated output at various different frequencies.

The **Mode** tab contains two parameters. The top row labeled Option is used to select the parameter is communicated through the OCT output. There are a total of nine options available, the menu choices are as follows:



Menu Item	Description of OCT signal
0. Flow Rate	Square wave pulse with frequency proportional to flow rate, 50% duty cycle
1. POS Total	Totalizer impulse output, one 200 ms pulse per specified increment of volume on the positive totalizer
2. NEG Total	Totalizer impulse output, one 200 ms pulse per specified increment of volume on the negative totalizer
3. NET Total	Totalizer impulse output, one 200 ms pulse per specified increment of volume on the net totalizer
4. Energy Rate*	Square wave pulse with frequency proportional to energy consumption rate, 50% duty cycle
5. Heat Total*	Totalizer impulse output, one 200 ms pulse per specified increment of energy on the heat totalizer
6. Cool Total*	Totalizer impulse output, one 200 ms pulse per specified increment of energy on the cool totalizer
7. Rationing	Batch control output
8. Uart CTRL	Asynchronous data communication

*Visible only on units ordered with the BTU/Energy measurement option

The row labeled FRange under the **Mode** tab is used to set the output frequency range when either "0.Flow Rate" or "4. Energy Rate" are selected in the Option row of this tab. Frequency ranges of up to 0-10000 Hz may be entered via the numeric keypad. If one of the totalizer impulse options, or the rationing, or the Uart Control is selected in the Option row, then the frequency range setting entered on this row is not used.

The range that the frequency output corresponds to is set in the **Range** tab of menu window M33. In the row labeled LowerL, the flow or energy rate that corresponds to the minimum frequency entered in the **Mode** tab is entered via the numeric keypad. The full-scale rate that corresponds to the maximum frequency is entered in the row labeled UpperL, as shown in the illustration below.

The **Check** tab may be used to generate an output frequency at various different levels for purposes of troubleshooting the meter or simulating an input signal to a device that the ALSONIC-FX2 is connected to. In the row labeled Option, simulated frequencies 500 Hz, 1000 Hz, 3000 Hz, and 5000 Hz may be selected using the **↑** and **↓** keys.

M33	CL Settings	*R
Mode	Range	Check
Option	0. Flow Rate	
FRange	0-10000 Hz	

M33	CL Settings	*R
Mode	Range	Check
LowerL	0.0	
UpperL	1000.0 m ³ /hr	

M33	CL Settings	*R
Mode	Range	Check
Option	0. Check 500	

M34

Relay Setting

The trigger event for actuating the ALSONIC-FX2's relay is controlled in menu window M34. Use the **↑** and **↓** keys to select from the following trigger events:

Menu Item	Description of event
a. No Signal	The relay is actuated when there is no signal detected between the transducers
b. *E	The relay is actuated when there is no signal detected (*E displayed in upper right corner)
c. Reverse	The relay is actuated when reverse flow is detected
d. Alarm1	The relay is actuated when the calculated flow rate is outside of the bounds set in menu M35, Alarm1
e. Alarm2	The relay is actuated when the calculated flow rate is outside of the bounds set in menu M35, Alarm1
f. Ration	The relay is actuated when the batch control total is reached
g. POS Total *	Totalizer impulse, one 200 ms relay closure per specified increment of volume on the positive totalizer
h. NEG Total	Totalizer impulse, one 200 ms relay closure per specified increment of volume on the negative totalizer
i. NET Total	Totalizer impulse, one 200 ms relay closure per specified increment of volume on the net totalizer
j. Not Using	The relay is inactive / not used when this option is chosen

M34	Relay Settings	*R
Option	a.No Signal	

M35

Alarm Setting

For applications where the meter's OCT or relay outputs need to be used to send an alarm signal to an external device to alert the user to a low flow rate that is below a minimum requirement or a high flow rate that exceeds a predetermined maximum flow, menu window M35 is used to establish the maximum and minimum thresholds that will be used to generate the alarm signal. This menu allows a total of two sets of maximum and minimum flow rates to be programmed into the instrument.

The **Alarm1** and **Alarm2** tabs each contain one set of maximum and minimum flow rates that are used for the alarm thresholds and each tab operates identically. The row labeled LowerL is for the minimum flow rate; use the numeric keypad to enter the desired value. For the maximum flow rate, use the numeric keypad to enter the desired value into the row labeled UpperL. Any flow rates that are below the minimum or above the maximum will generate an alarm condition.

M35	Alarm Settings	*R
Alarm1	Alarm2	
LowerL	0.0	m ³ /h
UpperL	1000.0	m ³ /h

M35	Alarm Settings	*R
Alarm1	Alarm2	
LowerL	100.0	m ³ /h
UpperL	900.0	m ³ /h

M36

Ration

The batch control option is configured in menu window M36. Use the \uparrow and \downarrow keys to select from the following four choices:

- a. Key CTRL b. AI1 CTRL c. AI2 CTRL d. Uart CTRL

M36	Ration	*R
Option	a. key CTRL	

M37

Micro SD

Menu window M37 determines what parameters are logged by the optional Micro SD card. The following two choices may be selected by using the \uparrow and \downarrow keys from row labeled Option:

- a. No Energy b. All

If "a.No Energy" is selected all of the parameters related to the liquid flow rate and totalizers will be recorded, but no parameters related to BTU/energy measurement will be recorded. If "b. All" is selected all of the parameters, including those related to the liquid flow rate and totalizers will be recorded **and** the BTU/energy measurement will be recorded.

The data collection interval is specified in the row labeled cycle. Use the numeric keypad to enter a value ranging from 1 to 3600 seconds.

M37	Micro SD	*R
Option	a. No Energy	
Cycle	600s	

M40

Toggle Unit

Either Metric or British measurement system may be selected for ALSONIC-FX2's units of measure in menu window M40. Use the \uparrow and \downarrow keys to select the desired measurement system as shown below.

M40	Toggle Unit	*R
Option	b. British	

M41

Flow Unit

The units of measure for the liquid flow rate and the liquid totalizer, as well as the multiplier for displayed flow rates and totals are all set in menu window M41. The flow rate units are set on the row labeled Rate under the **Unit** tab. Use the \uparrow and \downarrow keys to select from the following options:

- | | | |
|---|--|----------------------------------|
| 0. m ³ /hr (cubic meters per hour) | 1. l/h (liters per hour) | 2. GAL/h (U.S. gallons per hour) |
| 3. lg/h (Imperial gallons per hour) | 4. mg/h (Millions of gallons per hour) | 5. cf/h (cubic feet per hour) |
| 6. Ub/h (U.S. barrels per hour) | 7. lb/h (Imperial barrels per hour) | 8. Ob/h (Oil barrels per hour) |



The units of measure used by the liquid totalizer are set on the line labeled Total under the unit tab. Use the \uparrow and \downarrow keys to choose from the following nine options:

- 0. m³ (cubic meters) 1. l (liters) 2. GAL (U.S. gallons)
- 3. Ig (Imperial gallons) 4. mg (Millions of gallons) 5. cf (cubic feet)
- 6. Ub (U.S. barrels) 7. lb (Imperial barrels) 8. Ob (Oil barrels)

The **MULT.** tab allows a multiplier for the totalizer to be entered for situations where very small or very large accumulated totals need to be read. The following multipliers are available:

- a. 0.001 (E-1) b. 0.01 (E-2) c. 0.1 (E-1)
- d. 1 (E0) e. 10 (E+1) f. 100 (E+2)
- g.1000 (E+3) h. 10000 (E+4)

M41			Flow Unit	*R
Unit	MULT.			
Rate	m ³ /h			
Total	m ³			

M41			Flow Unit	*R
Unit	MULT.			
Option	d. *1			

M42

Energy Unit

Menu window M42 is only visible on units that are equipped with the BTU/Energy measurement options. This menu is used to enter the units of measure for energy consumption rate readings total energy used readings. A multiplier for the energy totalizer is also available in this window. The following energy units may be selected in the **Unit** tab:

- 0. Giga Joule (GJ) 1. Kilocalorie (Kc) 2. MBtu 3. KJ
- 4. Btu 5. KWh 6. MWh 7. TH

The time units that are used in conjunction with the selected energy unit for displaying the energy consumption rate are entered in the **Time** tab. The following choices are available:

- a. Day b. hour c. minute

The **MULT.** tab allows a multiplier for the energy totalizer to be entered for situations where very small or very large accumulated totals need to be read. The following multipliers are available:

- a. 0.001 (E-1) b. 0.01 (E-2) c. 0.1 (E-1)
- d. 1 (E0) e. 10 (E+1) f. 100 (E+2)
- g.1000 (E+3) h. 10000 (E+4)

M42			Energy Unit	*R
Unit	Time	MULT		
Option	4. BTU			

M42			Energy Unit	*R
Unit	Time	MULT		
Option	b. hour			

M42			Energy Unit	*R
Unit	Time	MULT		
Option	d. *1			

M43

Temperature Unit

Menu window M43 is only visible on units that are equipped with the BTU/Energy measurement options This menu is used to select the units of measurement for temperature readings. Use the \uparrow and \downarrow keys to select between °C and °F units of measure as shown below.

M43			TEMP Unit	*R
Option	a. °C			



M50

Serial Number

Menu window M50 is a read-only menu that displays the serial number and the software version that is presently installed on the flowmeter. The serial number displayed on the top row of this field should match the serial number that is shown on the outside of the meter's display enclosure.

M50	Serial Number	*R
S/N	FT888888	
SVN	V1.07	

M51

Time and Data

The time and date are entered in menu window M51. Use the numeric keypad to enter the current time on the row labeled Time and the current date on the row labeled Date, as show below.

M51	Time/Date	*R
Time	09:30:07	
Date	2020-8-14	

M52

Key Tone

Menu window M52 is used to enable or disable the audible tone for the display's keypad. Use the and keys to turn the tone on or off as shown below.

M52	Key Tone	*R
Option	0. On	

M53

Language

Menu window M53 is used to set the language for the display interface. Use the and keys to select the language as shown below.

M53	Language	*R
Option	0. English	

M54

System Lock

In order to prevent unauthorized changes to the instrument's pipe and setup parameters, the ALOSNIC-FX2 includes a password lock feature. The system lock is controlled in menu window M54. Lock the instrument. On the top line labeled Option, the system may be either locked or unlocked depending on it's current state, or an option to not use the lock may be selected. Users will be prompted to enter the current password before making any changes to the setting on the Option line. A new password to replace the existing password may be entered on the line labeled key, but users will once again be prompted to enter the old password before making any changes. Please contact the factory if the password is lost.

M54	System Lock	*R
Option	a. Locked	
Key	*****	

M55
System Reset

To wipe out all previously made programming menu changes and reset all of the ALSONIC-FX2's parameters back to their factory default state, navigate to menu window M55 and select option "1.Reset" on the line labeled Option. The line labeled Menu may be used to specify which menu window to boot to after the system rested is complete.

M55	System Reset	*R
Option	1. Reset	
Menu	M00	

M60
Date Totalizer

Menu window M60 may be used to view historical data from the meter's totalizer. In this window, it is possible to review the value displayed by the net totalizer for any day for the last 31 days, any month for last 12 months and any year for last 6 years. Use the numeric keypad to enter the desired day, month, and year into their respective tab as shown below. The totalizer value will be displayed on the bottom row of the menu, as shown below. In the example below, the day entered in the **Day** tab would be March 16, the month entered into the **Mon** tab would be March of 2020, and the year entered into the **Year** tab would be 2020.

M60	Date Totalizer	*R
Day	Mon	Year
Value	03-16	
	1988	m ³

M60	Date Totalizer	*R
Day	Mon	Year
Value	20-03	
	1988	m ³

M60	Date Totalizer	*R
Day	Mon	Year
Value	2020	
	1988	m ³

M61
Running Time

Menu window M61 is a read only menu that displays the meter's total working time since it left the factory.

M61	Running Time	*R
Value	129	h

M62
CL Adjust

Menu window M62 is used to calibrate the meter's 4-20 mA output, as previously described in section 5.10 of this manual. The analog 4-20 mA output is factory calibrated and under normal circumstances, it will not be necessary to use this menu.

M62	CL Adjust	*R
4mA	Enter to go	
20mA	Enter to go	

M63 RTD Adjust

Menu window M63 is only visible on meter's that are equipped with the BTU/Energy measurement option. This window is used for the RTD calibration; the procedure is the same as the menu window M62 current loop adjustment.

M63	RTD Adjust	*R
0 °C	Enter to go	
180 °C	Enter to go	



M64

AI Adjust

Menu window M63 is only visible on meter's that are equipped with the BTU/Energy measurement option. This widow is used for calibrating the meter's analog inputs and contains two menu tabs; **AI1** for analog input 1 and **AI2** for analog input 2. The procedure is the same for both menu tabs. To perform a calibration, a calibrated current source or a loop calibrator is required. The first step is to connect the loop calibrator to the input that is to be calibrated and then navigate to the corresponding tab in M64. Next, adjust the loop calibrator to produce an output of 4.00 mA, navigate to the row labeled 4 mA and press the enter key. If a value of 4.00 mA is not displayed on the screen, then use the **↑** and **↓** keys to adjust the reading on the screen until 4.00 is displayed. Finally, adjust the loop calibrator for an output of 20.00 mA, navigate to the row labeled 20mA and again use the arrow keys to adjust the value on the display as necessary.

As with the analog output, it is typically not necessary to perform this procedure as the analog inputs are factory calibrated.

M64		AI Adjust	*R
AI1	AI2		
4mA	Enter to go		
20mA	Enter to go		

M64		AI Adjust	*R
AI1	AI2		
4mA	Enter to go		
20mA	Enter to go		

7. Error Diagnostics

The ALSONIC-FX2 features advanced self-diagnostic functions. Any diagnosed errors are displayed in the upper right corner of the LCD via the error codes outlined below. All errors are logged in order by date/time. Some errors can be detected during normal operation. Undetectable errors caused by operator error, incorrect settings and unsuitable measurement conditions can be displayed accordingly while the instrument is working. This feature helps the user detect and diagnose errors quickly in order to minimize downtime. Please refer to the table below for definitions of error codes and possible causes.

If the problem can not be diagnosed using the table below, please contact the factory or the local authorized representative for assistance.

7.1. Table 1. Error Codes and Solutions (during operation)

Code	Meaning	Causes	Remedies
*R	System Normal	* System normal	
*E	Signal Not Detected	<ul style="list-style-type: none"> • Signal not detected. • Spacing between the transducers is not correct • Insufficient coupling compound applied to face of transducers. • Transducers installed improperly. • Pipe fouling / scale is too thick. • Excessive bubbles/ particulates entrained in the fluid media • Pipe liner unaccounted for in programming menus 	<ul style="list-style-type: none"> • Attach transducer to the pipe and tighten it securely. Apply a liberal amount of coupling compound on transducer face and pipe wall. • Remove any rust, scale, or loose paint from the pipe surface. Clean it with a file. • Check the initial parameter settings. • Remove the scale or change the fouled pipe section. Normally, it is possible to change a measurement location. The instrument may run properly at a new site with less scale. • Enter the liner data into menu window M11
*D	Adjusting Gain	* Adjusting gain for normal measurement.	



72. Frequently Asked Questions and Answers

Question: With new pipe, high quality material, and all installation requirements met, why is no signal detected?

Answer: Check pipe parameter settings, installation method and wiring connections. Confirm that a sufficient amount of coupling compound has been applied, the pipe is full of liquid, transducer spacing agrees with the value displayed in menu window M14 and that the transducers are installed in the correct direction.

Question: For old pipe that is heavily scale inside, no signal or a poor signal is detected. How can it be resolved?

Answer: Check if the pipe is full of fluid. Try the Z method for transducer installation (If the pipe is too close to a wall, or when is necessary to install the transducers on a vertical or inclined pipe with flow upwards instead of on a horizontal pipe).

Carefully select a good pipe section and thoroughly clean it; apply a wide band of coupling compound on each transducer face before and installing them onto the pipe.

Slowly and slightly move each transducer with respect to each other around the installation point until the maximum signal is detected. Be careful that the new installation location is free of scale inside the pipe and that the pipe is concentric (not deformed) so that the sound waves do not reflect outside of the area where the transducers are installed.

For pipe with thick scale on the inside or outside surface, try to clean the scale off, if the inside is accessible. (Note: Sometimes this method might not work and sound wave transmission is not possible due to a layer of scale between the transducers and the pipe inside wall).

Question: Why is the current loop output abnormal?

Answer: Check to see if the desired current output mode has been selected in menu window M32-Mode.

Check to see if the maximum and minimum current values are set properly in Windows M32-Range.

Re-calibrate the current loop and verify it in menu window M32-Check.

Question: Why is the flow rate still displayed as zero while there is fluid obviously inside the pipe and a symbol of "R" displayed on the screen?

Answer: Check to see if "Set Zero" procedure was performed with fluid flowing inside the pipe (Refer to Window M22).

If this is confirmed, perform a reset to factory default values in Window M22-Reset.

8. Appendix 1 – Serial Interface Network Use and Communications Protocol

8.1. Overview

The ALSONIC-FX2 has analog and frequency/pulse outputs. It can also communicate via RS485 Modbus .

Two basic schemes can be chosen for networking, i.e. the analog current output method only or the RS232 communication method via serial port directly from the flow meter. This method is suitable to replace dated instruments in old monitoring networks. The later method is used in new monitoring network systems. It has advantages including low hardware investment and reliable system operation.

When the serial port communications method is used to establish a network monitoring system, the address identification code of the flow meter is used as a network address code. Expanded command set with [W] is used as communication protocol.

RS-232 (Cable length 0~15m) or RS-485 (cable length 0~1000m) can be directly used for data transmission links over a short distance. The current loop can be used in medium or long distance transmission.

When the flow meter is used in a network environment, various operations can be performed by a host device, except for programming of the address identification code, which needs to be done via the flow meter keypad.

The command answer mode is used in data transmission, i.e. the host device issues commands and the flow meter answers correspondingly.



Attention

RS232 and RS485 serial communications cannot both be used at the same time.

8.2. Serial port definitions

Flow meter - RS232:	PIN 3 TXD send
TXD send	PIN 4 ground
RXD receive	PIN 5 ground
GND ground	PIN 6 empty
PC:	PIN 7 empty
PIN 1 empty	PIN 8 empty
PIN 2 RXD send	PIN9 empty

8.3. Direct connection via RS232 to the host device

See the below list of flowmeter serial port definitions.

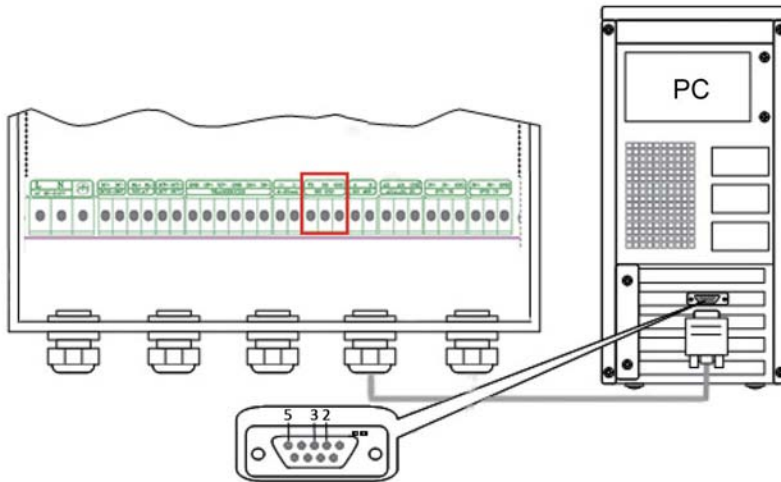

8.4. Communications protocol and use

The flow meter supports the following three communication protocols: FUJI Protocol, MODBUS-C Protocol, MODBUS-I Protocol.

8.4.1. HL Protocol

The communication protocol format used by the ultrasonic flow meter is an expanded set of the HL FLV series flow meter protocol. The host device requests the flow meter to answer by sending a "command". The baud rate of asynchronous communication (Primary station: computer system; Secondary station: ultrasonic flow meter) is generally 9600BPS. A single byte data format (10 bits): one start bit, one stop bit, 8 data bits, and no Check bits is used.

A data character string is used to express basic commands and a carriage return (ENTER) is used to express the end of a command. The characteristic is that the string of data is flexible. The order applies to both RS232 and RS485. Frequently used commands are as follows:



Communications commands

Command	Description	Data format
RFR(cr)(lf)	Return instantaneous flow	±d.ddddddE±dd(cr) Note1
RVV(cr)(lf)	Return instantaneous velocity	±d.ddddddE±dd(cr)
RT+(cr)(lf)	Return positive accumulative flow	±dddddd.dE±d(cr) Note2
RT-(cr)(lf)	Return negative accumulative flow	±dddddd.d±d(cr)
RTN(cr)(lf)	Return net accumulative flow	±dddddd.d±d(cr)
RTH(cr)(lf)	Return net accumulative energy(hot)	±dddddd.d±d(cr)
RTC(cr)(lf)	Return net accumulative energy(cold)	±dddddd.d±d(cr)
RER(cr)(lf)	Return instantaneous energy value	±d.ddddddE±dd(cr)
RA1(cr)(lf)	Return analog input value of AI1 (Temperature, Pressure, etc.)	±d.ddddddE±dd(cr)
RA2(cr)(lf)	Return analog input value of AI2 (Temperature, Pressure, etc.)	±d.ddddddE±dd(cr)
RID(cr)(lf)	Return Net address of the instrument	dddd(cr) 5 bits in length
RSS(cr)(lf)	Return signal intensity	UP:dd.d, DN:dd.d, Q=dd(cr)
REC(cr)(lf)	Return current error code	*R/*D/*E Note 3
RRS(cr)(lf)	Return Relay Status	ON/OFF(cr)
RDT(cr)(lf)	Current date and time	yy-mm-dd, hh:mm:ss(cr)
RSN(cr)(lf)	Return serial number	ddddddt(cr) Note 4
SFQddd. d(cr)(lf)	OCT setting	ddd.d(cr) Successful setting will revert back to "OK"
SCLdd.d(cr)(lf)	Current setting	dd.d(cr) Successful setting will revert back to "OK"
SRS(cr)(lf)	Start quantitative control	OK(cr) Successful setting will revert back to "OK"
P	Prefix of return command with check	Note 5
W	Networking command prefix of numeric string address	Note 6

Note:

- (cr)expresses carriage return. Its ASCII value is 0DH. (lf) expresses line feed. Its ASCII value is 0AH.
- "d" expresses 0-9 numeric value. 0 value is expressed as +0.000000E+00.
- "d" expresses 0-9 numeric value. There is no decimal point in integral part before "E".
- ddddddd means the serial number of the instrument, t means the model of the instrument.
- The character P can be added before every basic command. It means that the transferred data has CRC verification. The method of verification is to add all of the data back to the data, which is cumulative and binary, and its low 8-bit binary data is taken.
E.g. The return information of the RT(cr)(lf) is :+1234567E+0m3(cr)(lf), (the relative binary system data is 2BH, 31H, 32H, 33H, 34H, 35H, 36H, 37H, 45H, 2BH, 30H, 6DH, 33H, 20H, 0DH, 0AH) The sum of all of its return data is =2BH+31H+32H+33H+34H+35H+ 36H+37H+45H+2BH+30H+6DH+33H+20H= 2F7, The low 8-bit data of its binary is F7.
Therefore, the data of the order PRT (cr) (lf) is called + 1234567E + 0m3!F7 (cr) (lf), "!"For delimiters, the preceding is the character of the summation, followed by a check code of 1 byte.
- Usage of prefix W: W+ numeric string address code +basic command. Value range of the numeric string is 0 ~ 255, except 13 (0DH carriage return), 10 (0AH line feed). If the instantaneous velocity of address 123 flow meter is to be accessed, the command W123DV (cr)(lf) can be issued. The corresponding binary code is 57H, 31H, 32H, 33H, 44H, 56H, 0DH, 0AH, only the same instrument with the same address of the Internet address and command will send back the data.
- W and P commands can be used in combination, for example, W123PRT +, which means that the instrument that reads the network address is the cumulative value of the instrument with 123, and its return data has eight accumulations and checksums."s" expresses ON or OFF or UD. For example, "TR:ON, RL:ON" expresses that the OCT and relay are in an actuated status; "TR:UD, RL:UD" expresses that the OCT and relay are not actuated.

8.4.2. MODBUS-I Communication Protocol

This MODBUS-I Protocol uses RTU transmission mode. The Verification Code uses CRC-16-IBM (polynomial is $X^{16}+X^{15}+X^2+1$, shield character is 0xA001) which is gained by the cyclic redundancy algorithm method. MODBUS-I RTU mode uses hexadecimal numbering to transmit data.

1. MODBUS-I Protocol Function Code and Format

The flow meter protocol supports the following two-function codes of the MODBUS:

Function Code	Performance data
0x03	Read register
0x06	Write single register

2. MODBUS Protocol function code 0x03 usage

The host sends out the read register information frame format:

Slave Address	Operation Function Code	First Address Register	Register Number	Verify Code
1 byte	1 byte	2 bytes	2 bytes	2 bytes
0x01~0xF7	0x03	0x0000~0xFFFF	0x0000~0x7D	CRC (Verify)

The slave returns the data frame format:

Slave Address	Read Operation Function Code	Number of Data Bytes	Data Bytes	Verify Code
1 byte	1 byte	1 byte	N*x2 byte	2 bytes
0x01~0xF7	0x03	2xN	N*x2 (Data)	CRC (Verify)

N* = Data register number

3. MODBUS Protocol function code 0x06 usage

The host sends a command to write a single register information frame format (function code 0x06):

Slave Address	Operation Function Code	Register Address	Register Data	Verify Code
1 byte	1 byte	2 bytes	2 bytes	2 bytes
0x01~0xF7	0x06	0x0000~0xFFFF	0x0000~0xFFFF	CRC (Verify)

The slave returns the data frame format (function code 0x06):

Slave Address	Operation Function Code	Register Address	Register Data	Verify Code
1 byte	1 byte	2 bytes	2 bytes	2 bytes
0x01~0xF7	0x06	0x0000~0xFFFF	0x0000~0xFFFF	CRC (Verify)

The range of flow meter addresses is 1 to 247 (Hexadecimal: 0x01~0xF7), and can be checked in the Menu 46. For example, decimal number "11" displayed on Menu 46 means the address of the flow meter in the MODBUS protocol is 0x0B.

The CRC Verify Code uses CRC-16-IBM (polynomial is $X^{16}+X^{15}+X^2+1$, shield character is 0xA001) which is gained by the cyclic redundancy algorithm method. Low byte of the verify code is at the beginning while the high byte is at the end.

For example, to read the address 1 (0x01) in the RTU mode, if the instantaneous flow rate uses hour as a unit (m^3/h), namely reads 40005 and 40006 registers data, the read command is as follows:

0x01 0x03 0x00 0x04 0x00 0x02 0x85 0xCA

Flow meter Address Function Code First Address Register Register Numbers CRC Verify Code.

Flow meter returned data is (assuming the current flow= $1.234567m^3/h$). 0x01 0x03 0x04 0x06 0x51
0x3F 0x9E 0x3B 0x32

Flow meter Address Function Code Data Bytes Data (1.2345678) CRC Verify Code The four bytes 3F 9E 06 51 is in the IEEE754 format single precision floating point form of 1.2345678.

Pay attention to the data storage order of the above example. Using C language to explain the data, pointers can be used directly to input the required data in the corresponding variable address, the low byte will be put at the beginning, such as the above example 1.2345678 m/s, 3F 9E 06 51 data stored in order as 51 06 9E 3F.

For example, it converts the address 1 (0x01) to 2 (0x02) under the RTU mode, so to write the data of flowmeter 44100 register as 0x02, the write command is as follows:

0x01 0x06 0x10 0x03 0x00 0x02 0xFC 0xCB

Flow meter Address Function Code Register Address Register Number CRC Verify Code Flow meter returned data is:

0x01 0x06 0x10 0x03 0x00 0x02 0xFC 0xCB

Flow meter Address Function Code Register Address Register Number CRC Verify Code

4. Error Check

The flow meter only returns one error code 0x02 which means data first address in error. For example, to read address 1 (0x01) of the flow meter 40002 register data in the RTU mode, the flow meter considers it to be invalid data, and sends the following command: 0x01 0x03

0x00 0x01 0x00 0x01 0xD5 0xCA

Flow meter Address Function Code Register Address Register Number CRC Verify Code Flow meter returned error code is:

0x01 0x83 0x02 0xC0 0xF1

Flow meter Address Error Code Error Extended Code CRC Verify Code

5. MODBUS Register Address List

The flow meter MODBUS Register has a read register and a write single register.

a) Read Register Address List (use 0x03 function code to read)

PDU Address	Register	Read	Write	Type	No.
\$0000	40001	Flow/s-low word	32 bits real	2	
\$0001	40002	Flow/s-high word			
\$0002	40003	Flow/m-low word	32 bits real	2	
\$0003	40004	Flow/m-high word			
\$0004	40005	Flow/h-low word	32 bits real	2	
\$0005	40006	Flow/h-high word			
\$0006	40007	Velocity-low word	32 bits real	2	
\$0007	40008	Velocity-high word			



PDU Address	Register	Read	Write	Type	No. registers*
\$0008	40009	Positive total–low word	32 bits int.	2	
\$0009	40010	Positive total–high word			
\$000A	40011	Positive total–exponent	16 bits int.	1	
\$000B	40012	Negative total–low word			
\$000C	40013	Negative total–high word	32 bits int.	2	
\$000D	40014	Negative total–exponent			
\$000D	40014	Negative total–exponent	16 bits int.	1	
\$000E	40015	Net total–low word	32 bits int.	2	
\$000F	40016	Net total–high word			
\$0010	40017	Net total–exponent	16 bits int.	1	
\$0011	40018	Energy flow–low word	32 bits int.	2	
\$0012	40019	Energy flow–high word			
\$0013	40020	Energy total(hot)–low word	32 bits real	2	
\$0014	40021	Energy total(hot)–high word			
\$0015	40022	Energy total(hot)–exponent	16 bits int.	1	
\$0016	40023	Energy total(cold)–high word	32 bits real	2	
\$0017	40024	Energy total(cold)–exponent			
\$0018	40025	Energy total(cold)–exponent	16 bits int.	1	
\$0019	40026	Up signal int–low word	32 bits real	2	0~99.9
\$001A	40027	Up signal int–high word			
\$001B	40028	Down signal int–low word	32 bits real	2	0~99.9
\$001C	40029	Down signal int–high word			
\$001D	40030	Quality	16 bits int.	1	0~99
\$001E	40031	Error code – char 1	String	1	Refer to "Error Analysis" for detailed codes meanings.
\$003B	40060	Flow velocity unit –char 1,2	String	2	Only m/s right now
\$003C	40061	Flow velocity unit –char 3,4			



PDU Address	Register	Read	Write	Type	No. registers*
\$003D	40062	Flow rate unit-char 1,2	String	2	Note 1
\$003E	40063	Flow rate unit-char 3,4			
\$003F	40064	Flow total unit-char 1,2	String	1	
\$0040	40065	Energy rate unit-char 1,2	String	2	Note 2
\$0041	40066	Energy rate unit-char 3,4			
\$0042	40067	Energy total unit-char 1,2	String	1	
\$0043	40068	Instrument address	16 bits int	1	
\$0045	40070	Serial number-char 1,2	String	4	
\$0046	40071	Serial number-char 3,4			
\$0047	40072	Serial number-char 5,6	String	4	
\$0048	40073	Serial number-char 7,8			
\$0049	40074	Analog Input AI1 Value-low word	32 bits real	2	
\$004a	40075	Analog Input AI1 Value-high word			
\$004b	40076	Analog Input AI2 Value-low word	32 bits real	2	
\$004c	40077	Analog Input AI2 Value-high word			
\$004d	40078	4-20mA Value-low word	32 bits real	2	Unit: mA
\$004e	40079	4-20mA Value-high word			

b) Single Write Register Address List (use 0x06 performance code to write)

PDU Address	Register	Description	Read/Write	Type	No. registers*
\$1003	44100	Flow meter address (1-255)	R/W	16 bits int.	1
\$1004	44101	Communication Baud Rate 0 = 2400, 1 = 4800, 2 = 9600, 3 = 19200, 4 = 38400, 5 = 56000	R/W	16 bits int.	1



Notes:

1. The following flow rate units are available:
 0. "m3" -Cubic Meter
 1. "l" -Liters
 2. "ga" -Gallons
 3. "ig" -Imperial Gallons
 4. "mg" -Million Gallons
 5. "cf" -Cubic Feet
 6. "ba" -US Barrels
 7. "ib" -Imperial Barrels
 8. "ob" -Oil Barrels

2. The following energy units are available:
 0. "GJ" -Giga Joule
 1. "Kc" -Kilocalorie
 2. "MB" -MBtu
 3. "KJ" -Kilojoule
 4. "Bt" -Btu
 5. "Ts" -US Tonnes
 6. "Tn" -US Tons
 7. "kw" -Kwh

3. 16 bits int—short integer, 32 bits int – long integer, 32 bits real—floating point number, String—alphabetic string.



9. Appendix 2 - Flow Application Data

9.1. Sonic Velocities for Various Commonly Used Materials

Pipe Material	Sound Velocity (m/s)
Steel	3206
ABS	2286
Aluminum	3048
Brass	2270
Cast iron	2460
Bronze	2270
Fiber glass-epoxy	3430
Glass	3276
Polyethylene	1950
PVC	2540

Liner Material	Sound Velocity (m/s)
Teflon	1225
Titanium	3150
Cement	4190
Bitumen	2540
Porcelain enamel	2540
Glass	5970
Plastic	2280
Polyethylene	1600
PTFE	1450
Rubber	1600

**9.2. Sound Velocity in Water (1 atm) at various temperatures**

T (°C)	V (m/s)	T (°C)	V (m/s)	T (°C)	V (m/s)
0	1402.3	34	1517.7	68	1554.3
1	1407.3	35	1519.7	69	1554.5
2	1412.2	36	1521.7	70	1554.7
3	1416.9	37	1523.5	71	1554.9
4	1421.6	38	1525.3	72	1555.0
5	1426.1	39	1527.1	73	1555.0
6	1430.5	40	1528.8	74	1555.1
7	1434.8	41	1530.4	75	1555.1
8	1439.1	42	1532.0	76	1555.0
9	1443.2	43	1533.5	77	1554.9
10	1447.2	44	1534.9	78	1554.8
11	1451.1	45	1536.3	79	1554.6
12	1454.9	46	1537.7	80	1554.4
13	1458.7	47	1538.9	81	1554.2
14	1462.3	48	1540.2	82	1553.9
15	1465.8	49	1541.3	83	1553.6
16	1469.3	50	1542.5	84	1553.2
17	1472.7	51	1543.5	85	1552.8
18	1476.0	52	1544.6	86	1552.4
19	1479.1	53	1545.5	87	1552.0
20	1482.3	54	1546.4	88	1551.5
21	1485.3	55	1547.3	89	1551.0
22	1488.2	56	1548.1	90	1550.4
23	1491.1	57	1548.9	91	1549.8
24	1493.9	58	1549.6	92	1549.2
25	1496.6	59	1550.3	93	1548.5
26	1499.2	60	1550.9	94	1547.5
27	1501.8	61	1551.5	95	1547.1
28	1504.3	62	1552.0	96	1546.3
29	1506.7	63	1552.5	97	1545.6
30	1509.0	64	1553.0	98	1544.7
31	1511.3	65	1553.4	99	1543.9
32	1513.5	66	1553.7		
33	1515.7	67	1554.0		



SmartMeasurement USA
10437 Innovation Drive, Suite 315-Milwaukee, WI 53226
e-mail: sales@smartmeaurement.com
www.smartmeasurement.com