

## Pliers, Adjustable Combination

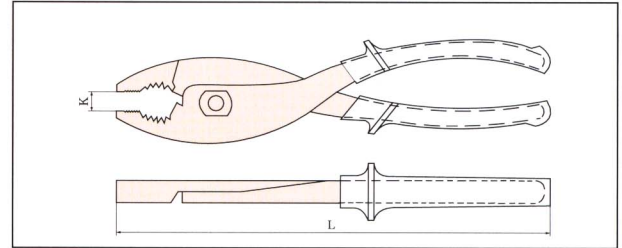

Number	L inch	L mm	K mm	Be-Cu g	Al-Cu g
245-1002	6	152	8	213	195
245-1004	8	203	13	323	295

## Pliers, Lineman

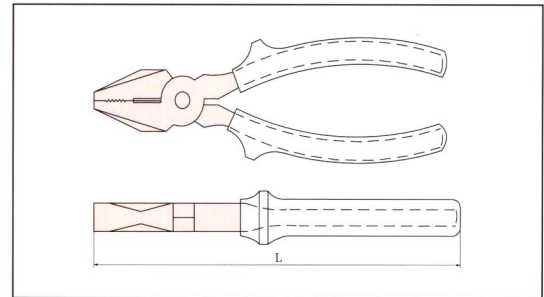

Number	L inch	L mm	Be-Cu g	Al-Cu g
246-1002	6	150	180	165
246-1004	7	175	306	280
246-1006	8	200	405	370
246-1008	10	250	502	460

## Pliers, Cutting

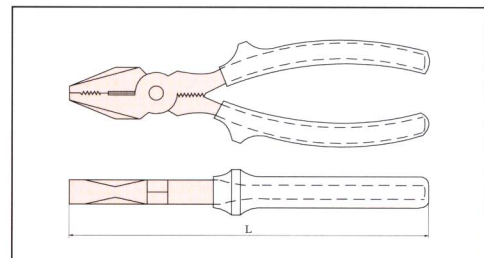

Number	L inch	L mm	Be-Cu g	Al-Cu g
247-1002	8	200	470	420



## Pliers, Groove Joint

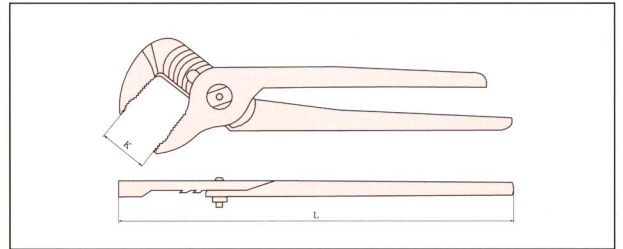

Number	L inch	L mm	K max mm	Be-Cu g	Al-Cu g
251-1002	6	150	25	150	137
251-1004	10	250	45	453	414
251-1006	12	300	55	745	700
251-1008	14	360	55	790	723

## Pliers, Slip Joint

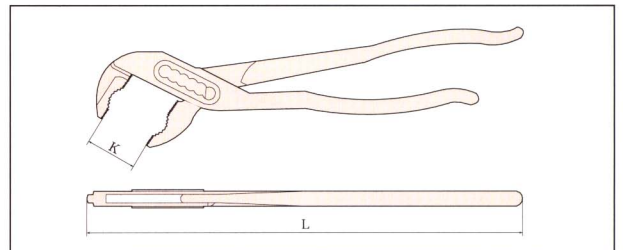

Number	L inch	L mm	K max mm	Be-Cu g	Al-Cu g
252-1002	10	250	32	365	335

## Pliers, Snipe Nose

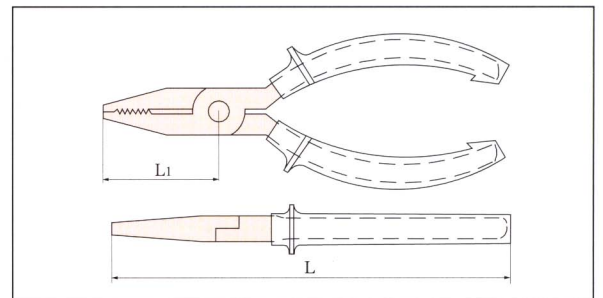
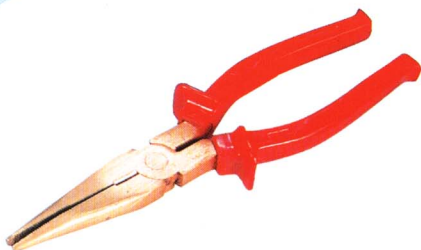

Number	L inch	L mm	Li mm	Be-Cu g	Al-Cu g
253-1002	6	150	54	165	151