

UDC2500 Universal Digital Controller

Specification

Overview

The UDC2500 Universal Digital Controller is a new, low-priced addition to Honeywell's Controller family.

This controller introduces new features in the popular low priced ¼ DIN size while retaining all the reliability, cost effectiveness, simplicity, and popular HMI of Honeywell's UDC 2300.

The UDC2500 monitors and controls temperatures and other variables in applications such as:

- furnaces and ovens,
- environmental chambers,
- packaging machinery,
- plastic processing machines.

Features

- 1 Universal Input + 1 high level input
- 0.25% Accuracy
- Fast scanning rate (166ms)
- Up to 5 Analog or Digital Output Types
- 2 Digital Inputs
- Ethernet and Modbus communication
- Infrared PC & Pocket PC configuration
- NEMA4X and IP66 front face protection
- Multilanguage prompts
- ¼ DIN Size
- Jumper free configuration
- Easily Field Upgradable
- Downward compatibility with existing UDC2300 applications
- Limit model

The standard features include Accutune III™ and the popular single display, automatic mode model. A Dual Display model with Automatic/Manual control modes is optional. A Limit Control model is also available.

The UDC2500 provides a ¼ DIN sized alternative for many applications. Its features include: Universal AC power supply, optional RS422/485 Modbus® RTU or Ethernet 10Base-T TCP/IP communication protocols, input/output isolation, Isolated Auxiliary Current output.



Figure 1 Front of UDC2500

When these are combined with the Accutune III™ tuning with fuzzy logic overshoot suppression, the result is price/performance leadership.

Configuration can be done with a PC through communication or with a Pocket PC, using the embedded infrared communication port. No need to get access to the back of the controller to download or upload a brand new configuration!

For the many thousands of satisfied UDC2300 users, the UDC2500 is downward-compatible with most existing UDC2300 applications.

Analog Inputs

The UDC2500 has two analog inputs with a typical accuracy of $\pm 0.25\%$ of full-scale input and a typical resolution of 16 bits. Both analog inputs are sampled six times per second (every 166 ms).

The first input is a low-level type which accepts thermocouple, RTD, ma, mV, and voltage types (See Table 1 on page 10.).

The second input is a high level type and can be used as a remote setpoint, for data acquisition or as a parameter to be alarmed on. This input accepts ranges 0-5V, 1-5V, 0-2V, 0-20mA or 4-20mA.

Cold junction compensation is provided for thermocouple type inputs. Upscale or downscale sensor break protection is keyboard configurable. A configurable digital filter of 0 to 120 seconds provides input signal damping.

All input types are configurable via the keyboard, there are no internal jumpers or switches. The two inputs are isolated from all other inputs and outputs, but not from each other.

Thermocouple Health - In addition to the standard configurable upscale, downscale or failsafe output burnout selections, the condition of the thermocouple can be monitored to determine if it is good, failing or in danger of imminent failure.

Digital Inputs

Two isolated digital inputs are provided for remote dry contact closure to select one of the following actions :

- Manual control mode.
- Local setpoint 1 or Local setpoint 2.
- Direct controller action.
- Hold SP Ramp/Program.
- Select PID set 2.
- Run - SP Ramp/Program.
- External program reset.
- Disable PID integral action.
- Manual mode, failsafe output.
- Disable keyboard.
- Start Timer.
- Initiate Tuning.
- Initiate PV Hot Start
- Output tracks Input 2.
- To Remote Setpoint.
- To Latching Manual Mode.

Also, the digital inputs can allow one of the following selections to be combined with one of the above selections:

- Select PID set 2.
- Direct controller action.
- Local setpoint 2 or Local setpoint 1.
- To Run.
- The 2nd Current Output and the 2nd Digital Input are mutually exclusive. Selection is made via a keyboard entry.

Outputs and Control

Five Outputs - The following output types are available:

- Current Outputs (4-20 or 0-20 ma)
- Electromechanical Relays (5 amps)
- Solid State Relays (1 amp)
- Dual Electromechanical Relays (2 amps)
- Open Collector Outputs

Output Algorithms - The UDC2500 is available with one or more of the following output algorithms:

- Time Proportional provides On-Off or Time Proportional (Relay) output.
- Current Proportional supplies proportional direct current output for final control elements, which require a 4-20mA signal. Output can be easily configured via the keyboard for 0-20mA operation without recalibration.
- Current Proportional Duplex is Similar to current proportional but provides a second set of tuning parameters and a split range current output or a second current output via the Auxiliary output option, for the heat and cool zones.

- Time Proportional Duplex - Depending on which control algorithm you select, this duplex output algorithm can provide On-Off Duplex, Time Proportional Duplex, or Three Position Step Control. The time proportional duplex output provides independent PID tuning constants and two time proportional outputs; one for heat zone above 50% output, and one for cool zone below 50% output.
- Current/Relay Duplex (Relay=Heat) - A variation of Duplex with Current active for 0 to 50% output (PID Set 2) and Relay 2 active 50 to 100% output (PID Set 1). Note that only one alarm is available.
- Relay/Current Duplex (Relay=Cool) - A variation of Duplex with Current active for 50 to 100% output and Relay 2 is active for 0 to 50% output. Note that only one alarm is available.

Heat/Cool Capability - Provides split range control with independent PID tuning constants—one for heating, one for cooling—plus mixed output forms.

Universal Outputs - UDC2500 provides “out of the box” operations, with no need to open the case. There are no jumpers to connect, no switches to set, and no hardware configuration required.

Control Algorithms - Depending on the output algorithms specified, the controller can be configured for the following control algorithms:

- On-Off
- PID-A
- PID-B
- PD with Manual Reset
- Three Position Step Control : The TPSC algorithm allows the control of a valve (or other actuator), with an electric motor driven by two controller output relays; one to move the motor upscale, the other downscale without a feedback slidewire linked to the motor shaft.
- 3 control modes:Manual, Automatic with Local Setpoint, Automatic with Remote Setpoint
- Bumpless, balanceless transfer between control modes. Available with a Dual Display option and SP Programming option.

Alarms

One or two electromechanical alarm relays are available to activate external equipment when preset alarm setpoints are reached. Each of the two alarms can be set to monitor two independent setpoints. Each alarm setpoint can be

either high or low alarm. The alarm type can be selected to be either of the inputs, the Process Variable, Deviation, Output, Shed from communications, PV rate of change, or to alarm on manual mode or a Current Output Open failure. It can also be used as an On or Off event at the beginning or end of a Ramp/Soak segment. The alarm hysteresis is configurable from 0 to 100% of range.

- Alarms can be configured as latching or non-latching.
- Alarm blocking is also available which allows start-up without alarm energized until after it first reaches the operating region.
- PV rate of change alarm.
- Loop break alarm.
- Timer output reset.

Communication

A communications link is provided between the UDC2500 and a host computer or PLC via the RS422/485 Modbus® RTU or Ethernet TCP/IP communications option. An infrared communication link is also available allowing a non-intrusive configuration of the instrument.

Miscellaneous

Auxiliary Output - This isolated Auxiliary Output can be scaled from 4-20 ma for 0 to 100% for any range. It can be configured to represent Input 1, Input 2, PV, active Setpoint, Local SP1, Deviation, or the Control Output.

Transmitter Power - This output provides up to 30 volts dc to power a 2-wire transmitter (it requires the use of alarm 2 open collector output selection or auxiliary output).

Dual Setpoints - A simple push-button selection allows to quickly switchover from primary to alternate setpoint with minimal operator confusion.

Universal Switching Power - Operates on any line voltage from 90 to 264 Vac 50/60 Hz without jumpers. 24 Vac/dc instrument power is available as an option.

Timer - This standard feature provides a configurable time period of 0 to 99 hours, 59 minutes or units of minutes and seconds. It can be started via the keyboard, alarm 2, or by a digital input. The timer output is Alarm 1 which energizes at the end of the Timer Period. Alarm 1 can be automatically reset. The Timer Period can be changed between each batch. Status is shown on the lower display.

Miscellaneous (continued)

Moisture Protection - The NEMA4X and IP66 rated front face permits use in applications where it may be subjected to moisture, dust, or hose-down conditions.

Setpoint Ramp/Soak Programming (Optional) - Enables you to program and store six Ramp and six Soak segments for setpoint programming. Run or Hold of program is keyboard or remote digital switch selectable.

Setpoint Rate - Lets you define a ramp rate to be applied to any local setpoint change. A separate upscale or downscale rate is configurable. A single setpoint ramp is also available as an alternative.

Limit Control - Provides a latching relay, which is activated whenever the PV goes above or below a preset setpoint value. An indicator will light when the output is activated and the lower display will show a message. Reset is through a key on the front of the controller or an external switch. A FM approved model is available.

CE Mark - Conformity with 73/23/EEC, Low Voltage Directive and 89/336/EEC, the EMC Directive as a standard feature.

Approval Body Options - CSA certification is available as an option. UL listing is standard.

Two Sets of Tuning Constants - Two sets of PID parameters can be configured for each loop and automatically or keyboard selected.

Data Security - Five levels of keyboard security protect tuning, configuration, and calibration data, accessed by a configurable 4-digit code. Nonvolatile EEPROM memory assures data integrity during loss of power.

Diagnostic/Failsafe Outputs - Continuous diagnostic routines detect failure modes, trigger a failsafe output value and identify the failure to minimize troubleshooting time.

High Noise Immunity - The controller is designed to provide reliable, error-free performance in industrial environments that often affect highly noise-sensitive digital equipment.

Quality/Support - The UDC2500 is covered by a 18-month warranty and backed up by a toll-free phone number for technical assistance (US Only).

Accutune III™ - This standard feature provides a truly plug and play tuning algorithm, which will, at the touch of a button or through a digital input, accurately identify and tune any process including those with deadtime and integrating processes. This speeds up and simplifies start-up plus allows retuning at any setpoint. The algorithm used is an improved version of the Accutune III™ algorithm. Two possibilities are now offered when tuning your process: Fast Tune and Slow Tune.

Fast Tune will tune the process in such a way that the temp is reached faster, a slight overshoot will be allowed.

Slowtune will minimize overshoot, but it will take more time for the process temperature to reach the target setpoint.

Heat/Cool (Duplex Tune) will automatically tune both the heating and cooling sides of the process.

Fuzzy Logic - This standard feature uses fuzzy logic to suppress process variable overshoot due to SP changes or externally induced process disturbances. It operates independently from Accutune III™ tuning. It does not change the PID constants, but temporarily modifies the internal controller response to suppress overshoot. This allows more aggressive tuning to co-exist with smooth PV response. It can be enabled or disabled depending on the application or the control criteria.

Displays— During normal operation, the upper display is dedicated to the process variable (4-digits) and special annunciator features. During configuration, the upper display provides guidance for the operator through prompts (6-characters). During normal operation for the dual display model, the lower display shows key-selected operating parameters such as Output, Setpoints, Inputs, Deviation, active Tuning Parameter Set, Timer Status, or minutes remaining in a setpoint ramp (4 digits). During configuration, the lower display provides guidance for the operator through prompts (6-characters).

You decide how the controller is to interact with the process by selecting, through simple keystrokes, the functions you want.

Multi-language prompts guide the operator step-by-step through the configuration process assuring quick and accurate entry of all configurable parameters. Five languages are available via configuration: English, French, German, Spanish and Italian.

Decimal Point Location— Configurable for none, one, or two places.

Dedicated Keys—Provide direct access setpoint modes and setpoint program status to simplify and speed operation.

Operator Interface

Indicators—Provide alarm, control mode, and temperature unit indication. There is also indication of when Remote Setpoint is active, the status of the control relays, and whether a setpoint program is in Run or Hold mode.

Operator Interface

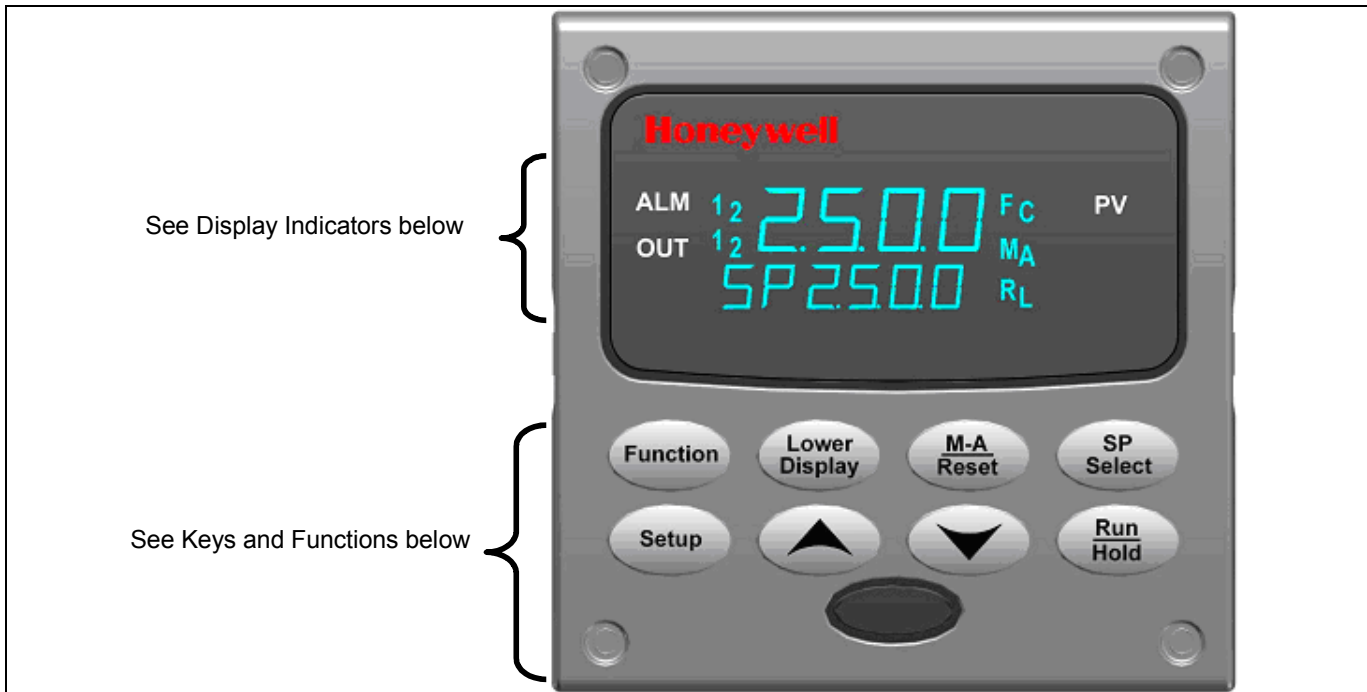



















Figure 2—Operator Interface (all display indicators shown)

Display Indicators

 Upper display with 4 larger digits shows Process Variable value (normal operation) or parameter value (configuration). Selectable decimal position.	 Indicates either degrees Fahrenheit or Centigrade.
 Lower display with 6 smaller characters shows operating parameters and values (normal operation) or functions and parameters (configuration). Selectable decimal position.	 Indicates either Manual or Auto mode.
 Indicates Alarm 1 and/or Alarm 2 conditions exist.	 Indicates either Remote or Local Setpoint2.
 Indicates Control Relay 1 and/or 2 on.	

Keys and Functions

 Selects functions within each configuration group.	 Selects Manual or Auto mode. Resets the latching limit Controller relay. In Set Up mode, used to restore original value or selection.
 Scrolls through the configuration groups.	 Hold key down to cycle through configured setpoints.
 Returns Controller to normal display from Set Up mode. Toggles various operating parameters for display.	 Enables Run/Hold of the SP Ramp or Program plus Timer start.
 Increases setpoint or output value. Increases the configuration values or changes functions in Configuration mode groups.	 Decreases setpoint or output value. Decreases the configuration values or changes functions in Configuration mode groups.
 Infrared transceiver	 NEMA4X and IP66 screw attachment (each corner)

PC & Pocket PC Software

Features

- Create configurations with intuitive software program running on either a Pocket PC, a Desktop or a laptop computer.
- Create/edit configurations live, just connect software to controller via comm port.
- Create/edit configurations offline and download to controller later via comm. port.
- Port types optionally available on every UDC2500:
 - Infrared
 - RS-485
 - Ethernet
- Same port types on UDC3200 and UDC3500 allow interconnectivity
- This software is available in English, Spanish, Italian, German and French.

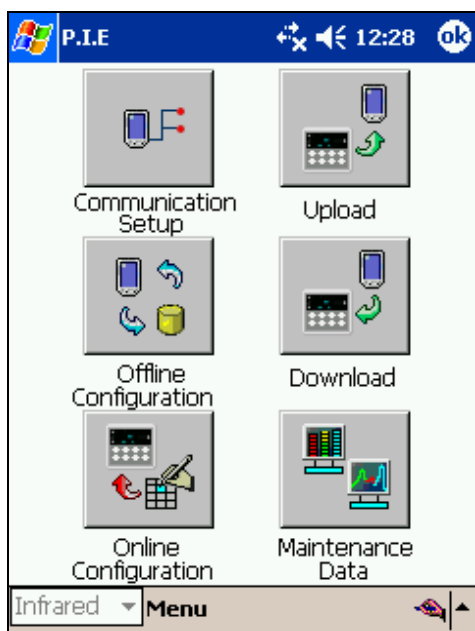

Screen capture of the configuration software running on a Pocket PC

Infrared Communications

The infrared connection provides a non-intrusive wireless connection with the instrument and maintains NEMA4X and IP66 integrity.

No need to get access to the back of the controller to communicate with the instrument, no need to take your screw driver to wire the communication cable, no wiring mistake possible ! You can now duplicate an instrument's configuration, upload or download a new configuration in a matter of seconds, just by pointing your Pocket PC in the direction of the instrument.

Aim & Upload! It takes less than 2 seconds to upload a configuration from an instrument ! You can then save the configuration file onto your PC or pocket PC for review, modification or archiving.

Furthermore, this software also gives you important maintenance information on the controller : instantly, get information on the current operating parameters, digital inputs and alarm status, identify internal or analog input problems.

Question : What if I have several controllers on the same panel? How can I be sure I am communicating with the correct one ?

Answer : The Infrared port is normally "off". You activate the infrared port on a particular controller by pressing any key. You can now communicate with the controller. If no communications are received for 2 minutes, the IR port will be shut down again.



Ethernet Communications

Widely used by manufacturers, the Ethernet connection, which uses Modbus TCP/IP, allows the controller to connect to other Ethernet networks and exchange data with computers or devices on that network for monitoring or managing your process from almost any location.

The Ethernet cable can be connected to a hub (using a straight through cable) or directly to a PC (using a crossed cable or straight through cable reconfigured at the UDC 2500 terminals)

The controller can be configured via the PC software. This software allows the user to configure all of the parameters included in the instrument and to monitor various parameters in the controller.

The controller can be configured to send an Email when an alarm condition has been encountered. The Email address and gateway are configured using the PC software.

Specifications

Design	
CE Conformity (Europe)	This product is in conformity with the protection requirements of the following European Council Directives: 73/23/EEC , the Low Voltage Directive, and 89/336/EEC , the EMC Directive. Conformity of this product with any other "CE Mark" Directive(s) shall not be assumed.
Product Classification	<i>Class I:</i> Permanently Connected, Panel Mounted Industrial Control Equipment with protective earthing (grounding).
Enclosure Rating	<i>Panel Mounted Equipment:</i> This controller must be panel mounted. Terminals must be within the panel enclosure. <i>Front Bezel:</i> NEMA3R and IP54, or NEMA4X and IP66 with 4 screws
Installation Category (Overvoltage Category)	<i>Category II:</i> Energy-consuming equipment supplied from the fixed installation. Local level appliances, and Industrial Control Equipment.
Pollution Degree	<i>Pollution Degree 2:</i> Normally non-conductive pollution with occasional conductivity caused by condensation. (Ref. IEC 664-1)
EMC Classification	Group 1, Class A, ISM Equipment (EN 55011, emissions), Industrial Equipment (EN61326, immunity)
Method of EMC Assessment Declaration of Conformity	Technical File (TF) 51453655
Approval Body Ratings	<i>UL Listed (Standard):</i> UL61010C-1 <i>CSA Certified (Optional):</i> CSA1010-1 <i>FM Approval for Limit Controller Model (Optional):</i> Class Number 3545
Analog Inputs (One or Two) (See Table 1 for Input Actuations)	<i>Accuracy:</i> <ul style="list-style-type: none"> • $\pm 0.25\%$ of full scale typical (± 1 digit for display) • Can be field calibrated to $\pm 0.05\%$ of full scale typical • 16-bit resolution typical <i>Sampling Rate:</i> Both inputs are sampled six times per second <i>Temperature Stability:</i> $\pm 0.01\%$ of Full Scale span / °C change—typical <i>Input Impedance:</i> <ul style="list-style-type: none"> • 4-20 Milliampere Input: 250 ohms • 0-10 Volt Input: 200K ohms • All Other: 10 megohms <i>Maximum Lead Wire Resistance:</i> <ul style="list-style-type: none"> • Thermocouples: 50 ohms/leg • 100 ohm, 200 ohm and 500 ohm RTD: 100 ohms/leg • 100 ohm Low RTD: 10 ohms/leg
Analog Input Signal Failure Operation	<i>Burnout Selections:</i> Upscale, Downscale, Failsafe or None <i>Thermocouple Health:</i> Good, Failing, Failure Imminent or Failed <i>Failsafe Output Level:</i> Configurable 0-100% of Output range
Analog Input Filter	<i>Software:</i> Single pole lowpass section with selectable time constants, off to 120 seconds, available on both analog inputs.
Stray Rejection	Common Mode <i>AC (50 or 60 Hz):</i> 120 dB (with maximum source impedance of 100 ohms) or ± 1 LSB (least significant bit) whichever is greater with line voltage applied. <i>DC:</i> 120 dB (with maximum source impedance of 100 ohms) or a ± 1 LSB whichever is greater with 120 Vdc applied. <i>DC (to 1 KHz):</i> 80 dB (with maximum source of impedance of 100 ohms) or ± 1 LSB whichever is greater with 50 Vac applied. Normal Mode <i>AC (50 or 60 Hz):</i> 60 dB (with 100% span peak-to-peak maximum)

Specifications

Design	
Digital Inputs (Two) (Optional)	<p>+30 Vdc source for external dry contacts or isolated solid state contacts. Digital Inputs are isolated from line power, earth ground, analog inputs and all outputs except for the Second Current Output.</p> <p>On contact closure the controller will respond according to how each digital input is configured. Opening the contact causes a return to previous state.</p> <p>The second Digital Input is mutually exclusive with the Second Current Output.</p>
Controller Output Types	<p>Electromechanical Relays (One or Two) SPDT contacts. Both Normally Open and Normally Closed contacts are brought out to the rear terminals. Internally socketed <i>Resistive Load:</i> 5 amps @ 120 Vac or 240 Vac or 30 Vdc <i>Inductive Load (cos φ = 0.4):</i> 3 amps @ 130 Vac or 250 Vac <i>Inductive Load (L/R = 7 msec):</i> 3.5 amps @ 30 Vdc <i>Motor:</i> 1/6 H.P.</p> <p>Dual Electromechanical Relays Two SPST relays. One Normally Closed contact for each relay is brought out to the rear terminals. This option takes the place of one of the above electromechanical relays, and is especially useful for Time Duplex or Three Position Step Control applications. Instruments with this option can have a total of 4 relays plus one current output. Internally socketed <i>Resistive Load:</i> 2 amps @ 120 Vac, 240 Vac or 30 Vdc <i>Inductive Load (cos φ = 0.4):</i> 1 amp @ 130 Vac or 250 Vac <i>Inductive Load (L/R = 7 msec):</i> 1 amp @ 30 Vdc</p> <p>Solid State Relays (One or Two) Zero-crossing type SPST solid state contacts consisting of a triac N.O. output. Internally socketed. <i>Resistive Load:</i> 1.0 amp @ 25°C and 120 or 240 Vac 0.5 amp @ 55°C and 120 or 240 Vac <i>Inductive Load:</i> 50 VA @ 120 Vac or 240 Vac <i>Minimum Load:</i> 20 milliamps</p> <p>Open Collector Outputs (One or Two) Socketed assembly replacing a relay. Opto-isolated from all other circuits except current output, but not from each other. Internally powered @ 30 Vdc. Note: Applying an external power supply to this output will damage the instrument. <i>Maximum Sink Current:</i> 20 mA <i>Overload Protection:</i> 100 mA</p> <p>Current Outputs (One or Two) These outputs provide a 21 mA dc maximum into a negative or positive grounded load or into a non-grounded load. Current outputs are isolated from each other, line power, earth ground and all inputs. Outputs can be easily configured via the keyboard to be 0 to 20 or 4 to 20 mA without field calibration and for either direct or reverse action. The second current output can be used in an Auxiliary Output mode. This Auxiliary Output can be configured to represent either Input, PV, Setpoint, Deviation, or Control output. The range of an Auxiliary Output can be scaled per the range of the selected variable and can be set anywhere between 0 to 21 mA. The Second Current Output is mutually exclusive with the second Digital Input. <i>Resolution:</i> 12 bits over 0 to 21 mA <i>Accuracy:</i> 0.05% of full scale <i>Temperature Stability:</i> 0.01% F.S./°C <i>Load Resistance:</i> 0 to 1000 ohms</p>
Alarm Outputs (Optional)	<p>One SPDT electromechanical relay. A second alarm is available if the second control relay is not used for control purposes.</p> <p>Up to four setpoints are independently set as high or low alarm, two for each relay. Setpoint can be on any Input, Process Variable, Deviation, Manual Mode, Failsafe, PV Rate, RSP Mode, Communication Shed, or Output. A single adjustable hysteresis of 0.0 to 100.0% is provided. The alarm can also be set as an ON or OFF event at the beginning of a setpoint ramp/soak segment.</p> <p><i>Alarm Relay Contacts Rating</i> <i>Resistive Load:</i> 5 amps at 120 Vac or 240 Vac or 30 Vdc</p>

Specifications

Design	
RS422/485 Modbus RTU Communications Interface (Optional)	<p><i>Baud Rate:</i> 4800, 9600, 19,200 or 38,400 baud selectable <i>Data Format:</i> Floating point or integer <i>Length of Link:</i> 2000 ft (600 m) max. with Belden 9271 Twinax Cable and 120 ohm termination resistors 4000 ft. (1200 m) max. with Belden 8227 Twinax Cable and 100 ohm termination resistors <i>Link Characteristics:</i> Two-wire, multi-drop Modbus RTU protocol, 15 drops maximum or up to 31 drops for shorter link length.</p>
Ethernet TCP/IP Communications Interface (Optional)	<p><i>Type:</i> 10Base-T <i>Length of Link:</i> 330 ft. (100 m) maximum <i>Link Characteristics:</i> Four-wire, single drop, five hops maximum <i>IP Address:</i> IP Address is 10.0.0.2 as shipped from the Factory <i>Recommended network configuration:</i> Use Switch rather than Hub in order to maximize UDC Ethernet performance.</p>
Infrared Communications (Optional)	<p><i>Type:</i> Serial Infrared (SIR) <i>Length of Link:</i> 3 ft. (1 m) maximum for IrDA 1.0 compliant devices <i>Baud Rate:</i> 19,200 or 38,400 baud selectable</p>
Controller Output Algorithms	<p>On-Off or Time Proportional One relay or open collector output. Control action can be set for direct or reverse. <i>Time Proportional Relay Resolution:</i> 3.3 msec</p> <p>On-Off Duplex, Three Position Step Control, or Time Proportional Duplex Two relays or open collector outputs. Control action can be set for direct or reverse. <i>Time Proportional Relay Resolution:</i> 3.3 msec</p> <p>Current Proportional A single 4-20 mA current output signal which can be configured for direct or reverse action.</p> <p>Current Proportional Duplex This can be a single current output can providing both heat and cool signals (4-12 mA cool, 12-20 mA heat) or a combination of both current outputs with the First Current Output providing the Heat output (Heat = 50 to 100% of range) and Second Current Output providing the Cool output (Cool = 0 to 50% of range). Both are 4-20 mA signals which can be set for direct or reverse action.</p> <p>Current/Time Duplex Variation of time proportional duplex for Heat/Cool applications. Time proportional output (heat or cool) is a relay. Current proportional output (Heat or Cool) is a 4-20 mA signal that can be fed into a negative or positive grounded load of 0 to 1000 ohms and is operational over 50% of range or the entire range.</p>
Digital Displays	<p>Vacuum fluorescent, alphanumeric A four-character upper display dedicated to the process variable (4 digits). Alternate information displayed during configuration mode. A six-character lower display primarily shows key selected operating parameters (4 digits). Alternate information displayed during configuration mode.</p>
Indicators	<p>Alarm Relay Status (ALM 1 or 2) Control Mode (A or MAN) Temperature Units (F or C) Local Setpoint 1 Active (L) Remote Setpoint or Local Setpoint 2 Active (R) Control Relay Status (OUT 1 or 2)</p>
Modes of Operation	<p>Manual Automatic with Local Setpoint Automatic with Remote Setpoint</p>
Dimensions	See Figure 5.
Mounting	Panel-mounted, 4.5-inch (114 mm) depth
Wiring Connections	Screw terminals on the rear of the case. (See Figure 6.)
Power Consumption	<p>20 VA maximum (90 to 264 Vac) 15 VA maximum (24 Vac/dc)</p>

Specifications

Design	
Power Inrush Current	10A maximum for 4 ms (under operating conditions), reducing to a maximum of 225 mA (90 to 264 Vac operation) or 750 mA (24 Vac/dc operation) after one second. CAUTION: When applying power to more than one instrument, make sure that sufficient power is supplied. Otherwise, the instruments may not start up normally due to voltage drop from the inrush current.
Weight	3 lbs. (1.3 kg)

Environmental and Operating Conditions				
Parameter	Reference	Rated	Operative Limits	Transportation and Storage
Ambient Temperature	25 ± 3°C 77 ± 5°F	15 to 55°C 58 to 131°F	0 to 55°C 32 to 131°F	-40 to 66°C -40 to 151°F
Relative Humidity	10 to 55*	10 to 90*	5 to 90*	5 to 95*
Vibration				
Frequency (Hz)	0	0 to 70	0 to 200	0 to 200
Acceleration (g)	0	0.4	0.6	0.5
Mechanical Shock				
Acceleration (g)	0	1	5	20
Duration (ms))	0	30	30	30
Line Voltage (Vdc)	+24 ±1	+22 to +27	+20 to +27	--
Voltage (Vac)				
90 to 264 Vac	120 ±1 240 ±2	90 to 264	90 to 264	-- --
24 Vac	24 ± 1	20 to 27	20 to 27	--
Frequency (Hz)	50 ±0.2 60 ±0.2	49 to 51 59 to 61	48 to 52 58 to 62	-- --
(For Vac)				

* The maximum RH rating applies only up to 40°C (104°F). For higher temperatures, the RH specification is derated to maintain constant moisture content.

Table 1—Input Actuators

Input 1 Actuation	Range	
	°F	°C
Thermocouples (Per ITS-90)		
B	0 to 3300	-18 to 1816
E	-454 to 1832	-270 to 1000
E (low)	-200 to 1100	-129 to 593
J	0 to 1600	-18 to 871
J (med)	20 to 900	-7 to 482
J (low)	20 to 550	-7 to 288
K	0 to 2400	-18 to 1316
K (med)	-20 to 1200	-29 to 649
K (low)	-20 to 750	-29 to 399
NiMo-NiCo(NN190)	32 to 2500	0 to 1371
NiMo-NiCo (low)	32 to 1260	0 to 682
Nicrosil-Nisil (NIC)	0 to 2372	-18 to 1300
NIC (low)	0 to 1472	-18 to 800
R	0 to 3100	-18 to 1704
S	0 to 3100	-18 to 1704
T	-300 to 700	-184 to 371
T (low)	-200 to 500	-129 to 260
W5W26	0 to 4200	-18 to 2315
W5W26 (low)	0 to 2240	-18 to 1227
Honeywell Radomatic		
Type RH	0 to 3400	-18 to 1871
Type RI	0 to 9999 max.*	-18 to 9999 max.*
Differential Thermocouple**	-50 to 150	-46 to 66

*User enters the range manually per RI type and application.
** Factory calibrated for pair of J thermocouples at an ambient temperature mean of 450°F / 232°C. Can be Field Calibrated for other ambient temperatures or other Thermocouple types.

Input 1 Actuation	Range	
	°F	°C
RTD Per IEC-60751 (1995) IEC Alpha = 0.00385		
100 ohms	-300 to 1200	-184 to 649
100 ohms (low)	-300 to 300	-184 to 149
200 ohms	-300 to 1200	-184 to 649
500 ohms	-300 to 1200	-184 to 649
Linear		
Milliamps	4 to 20 mA *** 0 to 20 mA ***	
Millivolts	0 to 10 mV 0 to 50 mV 0 to 100 mV	
Volts	1 to 5 V 0 to 5 V 0 to 10V ***	
Input 2 Actuation		
Milliamps	4 to 20 mA **** 0 to 20 mA ****	
Volts	1 to 5 V 0 to 5 V 0 to 2 V	

*** Requires external dropping resistor assembly (Honeywell supplied).
**** Input 2 has an internal dropping resistor for milliamp inputs.

General Reference Data

Isolation (Functional)	<p><i>Analog Inputs</i> : are isolated from all other circuits at 850Vdc for 2 seconds, but not from each other.</p> <p><i>Analog Outputs</i> : are isolated from all other circuits at 850Vdc for 2 seconds.</p> <p><i>AC Power</i> : is electrically isolated from all other inputs and outputs to withstand a HIPOT potential of 1900Vdc for 2 seconds per Annex K of EN61010-1.</p> <p><i>Relay Contacts</i> : with a working voltage of 115/230 Vac, are isolated from each other and all other circuits at 345Vdc for 2 seconds.</p>
Surge Withstand Capability (SWC)	<p><i>Immunity</i>: ANSI/IEEE C37.90.1, Surge Withstand Capability (SWC) (Formerly IEEE 472). Mains power input and relay contact outputs: 2.5 kV, Common Mode and Differential Mode. All other circuits: 1.0 kV, Common Mode and Differential Mode. The instrument is capable of meeting these test levels with no component failures, no reset, and no incorrect outputs.</p>
Radio Frequency Interference (RFI)	<p><i>Immunity</i>: No effect on performance from a 5 W walkie-talkie operated at 27, 151 or 450 MHz, one meter from the controller.</p>

Model Number Interpretation

Instructions

- Select the desired key number. The arrow to the right marks the selection available.
- Make the desired selections from Tables I through V using the column below the proper arrow. A dot (*) denotes availability.

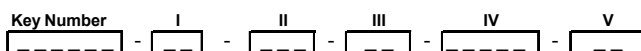

KEY NUMBER - UDC2500 Single Loop Controller

Description	Selection	Availability
Digital Controller for use with 90 to 264Vac Power	DC2500	↓
Digital Controller for use with 24Vac/dc Power	DC2501	↓

TABLE I - Specify Control Output and/or Alarms

Output #	Description	Selection	Availability
Output #1	None (Can be used as an indicator only)	0 _	• •
	Current Output (4 to 20ma, 0 to 20 ma)	C _	• •
	Electro Mechanical Relay (5 Amp Form C)	E _	• •
	Solid State Relay (1 Amp)	A _	• •
	Open Collector transistor output	T _	• •
	Dual 2 Amp Relays (Both are Form A) (Heat/Cool Applications)	R _	• •
Output #2 and Alarm #1 or Alarms 1 and 2	No Additional Outputs or Alarms	_ 0	• •
	One Alarm Relay Only	_ B	• •
	E-M Relay (5 Amp Form C) Plus Alarm 1 (5 Amp Form C Relay)	_ E	• •
	Solid State Relay (1 Amp) Plus Alarm 1 (5 Amp Form C Relay)	_ A	• •
	Open Collector Plus Alarm 1 (5 Amp Form C Relay)	_ T	• •
			_ R

TABLE II - Communications and Software Selections

	Description	Selection	Availability DC 2500	Availability 2501
Communications	None	0 _ _ _	•	•
	Auxiliary Output/Digital Inputs (1 Aux and 1 DI or 2 DI)	1 _ _ _	•	•
	RS-485 Modbus Plus Auxiliary Output/Digital Inputs	2 _ _ _	•	•
Software Selections	10 Base-T Ethernet (Modbus RTU) Plus Auxiliary Output/Digital Inputs	3 _ _ _	•	•
	Standard Functions, Single Display	_ 0 _ _	•	•
	Dual Display with Auto/Manual	_ A _ _	•	•
Reserved	Set Point Programming (12 Segments) Dual Display, Auto/Manual	_ B _ _	•	•
	Limit Controller	_ L _ _	a	a
Infrared interface	No Selection	_ _ 0 _	•	•
	None	_ _ _ 0	•	•
	Infrared Interface Included (Can be used with a Pocket PC)	_ _ _ R	•	•

TABLE III - Input 1 can be changed in the field using external resistors

Input	Description	Selection	Availability DC 2500	Availability 2501
Input 1	TC, RTD, mV, 0-5V, 1-5V	1 _	•	•
	TC, RTD, mV, 0-5V, 1-5V, 0-20mA, 4-20mA	2 _	•	•
	TC, RTD, mV, 0-5V, 1-5V, 0-20mA, 4-20mA, 0-10V	3 _	•	•
Input 2	None	_ 0	•	•
	0-5V, 1-5V, 0-20mA, 4-20mA	_ 1	•	•

TABLE IV - Options

	Description	Selection	Availability DC 2500	Availability 2501
Approvals	CE, UL and CSA (Standard)	0 _ _ _	•	•
	CE, UL, CSA and FM	1 _ _ _	•	b
Tags	None	_ 0 _ _	•	•
	Linen Customer ID Tag - 3 lines w/22 characters/line	_ T _ _	•	•
Future Options	Stainless Steel Customer ID Tag - 3 lines w/22 characters/line	_ S _ _	•	•
	None	_ _ 0 _	•	•
	None	_ _ _ 0	•	•

TABLE V - Product Manuals

	Description	Selection	Availability DC 2500	Availability 2501
Manuals	Product Information on CD - All Languages	0 _	•	•
	English Manual (51-52-25-127)	E _	•	•
	French Manual (51-52-25-127-FR)	F _	•	•
	German Manual (51-52-25-127-DE)	G _	•	•
	Italian Manual (51-52-25-127-IT)	I _	•	•
	Spanish Manual (51-52-25-127-SP)	S _	•	•
Certificate	None	_ 0	•	•
	Certificate of Conformance (F3391)	_ C	•	•

RESTRICTIONS

Restriction Letters	Available Only With		Not Available With	
	Table	Selection	Table	Selection
a	I	E _		
	I	A _		
Limit Controller Restrictions/Comments:				
1. FM approved units with communications are limited to read only.				
2. FM approved units are restricted to TC and RTD type inputs.				
3. UL listed for regulatory use only.				
b	II	_ L _		

Dimensions

The controller is housed in a 4.5-inch (114 mm) deep, black plastic case with a dark gray elastomer bezel, that can be panel mounted in a 1/4 DIN cutout. The plug-in chassis allows easy access to the controller board and its various option boards. All power, input, and output wiring are connected to screw terminals on the rear panel. (See Figure 6.)

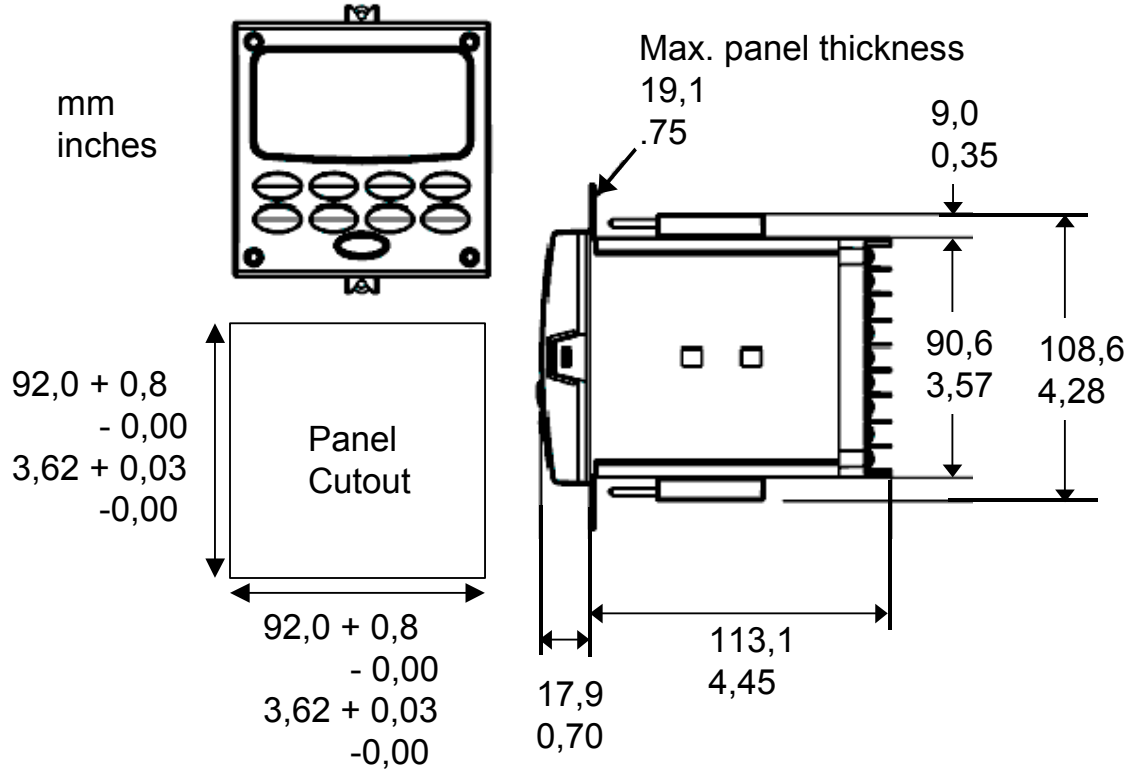
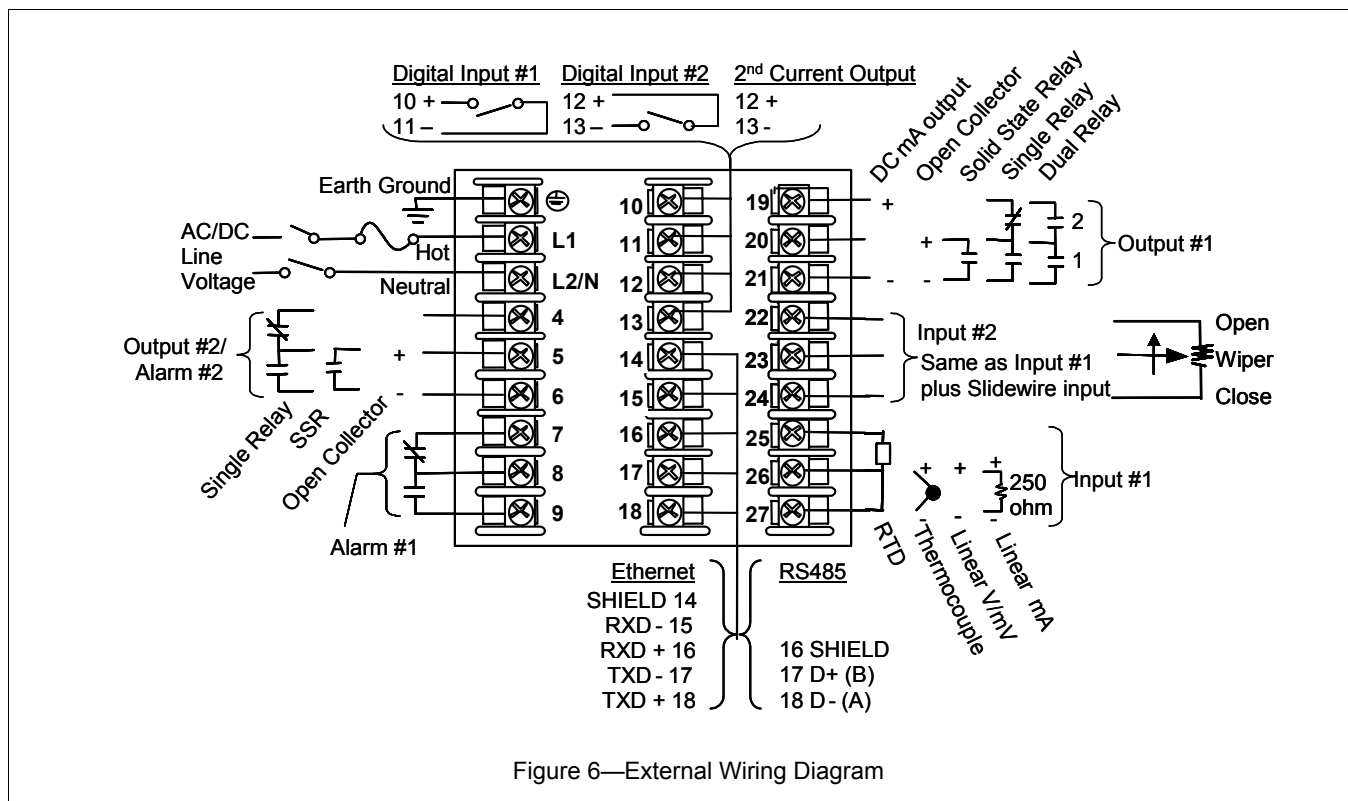

Figure 5—UDC2500 Controller and Cutout Dimensions

Wiring Diagram



Ordering Information

For the complete ordering information on the UDC2500, request Model Selection Guide 51-51 16-79.

Honeywell offers a full line of Sensors, Transmitters, and Final Control Devices for use with the UDC2500 Universal Digital Controller. These devices include:

- Thermocouples,
- RTDs,
- Pressure Transmitters,
- Flow Transmitters,
- Liquid Level Transmitters,
- Valves,
- Actuators, and
- Electric Motors.

Specifications are subject to change without notice.

Warranty/Remedy

Honeywell warrants goods of its manufacture as being free of defective materials and faulty workmanship. Contact your local sales office for warranty information. If warranted goods are returned to Honeywell during the period of coverage, Honeywell will repair or replace without charge those items it finds defective. The foregoing is Buyer's sole remedy and is **in lieu of all other warranties, expressed or implied, including those of merchantability and fitness for a particular purpose**. Specifications may change without notice. The information we supply is believed to be accurate and reliable as of this printing. However, we assume no responsibility for its use.

While we provide application assistance personally, through our literature and the Honeywell web site, it is up to the customer to determine the suitability of the product in the application.

Distributor :

For more information, contact Honeywell sales at:
US: 1-800-343-0228
Canada: 1-800-461-0013

Industrial Measurement and Control

Honeywell
1100 Virginia Drive
Fort Washington, PA 19034