

## Model

# SCF

## Cone Type Flowmeter

### Introduction

The Cone is a differential head flowmeter consisting of a circular cone placed in the center of a pipe section with two pressure taps. The upstream pressure tap is placed at a point where flow is undisturbed by the cone, and the downstream tap at the end of the cone facing downstream. The liquid or gas flows through the annular gap formed between the pipe wall and the cone, inducing a differential head that is proportional to the flow rate.

The Cone Type Flowmeter is supplied as a spool piece to be installed between two flanges. The principal advantage of this flowmeter is in that it does not require a long straight section of pipe upstream of the meter.

In most cases pieces of pipe 3x diameters long placed upstream and downstream of the spool piece assure accurate and repeatable measurement of flow rates.

This important feature, unique to the Cone Type Flowmeter, results from the fact that the cone reshapes the incoming flow field at the annulus and unlike the orifice flowmeter, an accurate flow rate measurement does not depend on the fully developed turbulent flow profile. This feature can significantly contribute to the efficient utilization of plant space for piping layout.

All Cone Type Flowmeters are supplied with calibration certificates.



### Specifications

#### STANDARD ACCURACY

±0.5% of actual flowrate

#### REPEATABILITY

0.1% or better

#### STANDARD BETA RATIOS

0.4, 0.5, 0.6, 0.75: special Betas are available from 0.3 to 0.92

#### HEAD LOSS

Approximately 20% of the generated differential pressure

#### INSTALLATION PIPING REQUIREMENTS

1 to 2 diameters upstream: 3 to 5 diameters downstream

#### FLANGE RATING

JIS 10K, 20K, 30K etc.  
ANSI(or JPI) 150, 300, 600 etc.

#### MATERIALS OF CONSTRUCTION INCLUDED

Standard: 304SS, 316SS, Carbon  
Special materials on request

#### LINE SIZES AVAILABLE

0.5" to 40" and large

#### END FITTINGS

Flanged, threaded, or weld-end standard  
Others on request

#### DISCHARGE COEFFICIENTS

0.70 to 0.85 typical

#### PRESSURE

600 psig max

#### TEMPERATURE

370°C

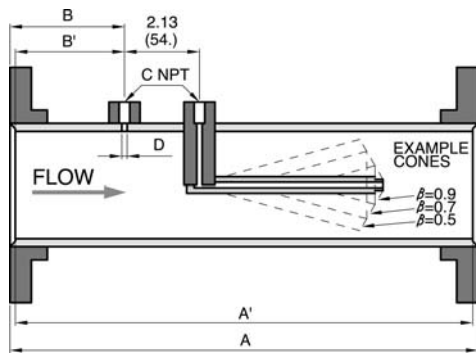

SCF-A

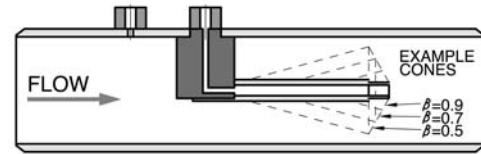

SCF-B

## Principle

SCF's operating principle is the same as other pressure differential flow meters. Cone device is inserted into a center of pipe which will reduce the flow area. The intentional reduction in flow area will cause a local increase in velocity and a measurable local pressure drop across the flow path. So the pressure drop is in part due to the so-called Bernoulli effect between A and B.

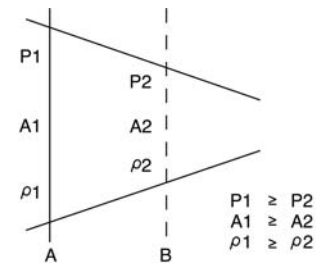

Differential Pressure ( $\Delta p$ ) and Flow Rate ( $Q_v$ )

$$Q_v \propto k \sqrt{\Delta p}$$

Effectual Area Ratio (m),

$$M = \frac{D^2 - d^2}{D^2}, \quad \beta = \frac{D^2 - d^2}{D^2}$$

Therefore, Flow Rate

$$Q_v = c_d \cdot A_2 \cdot E \cdot \varepsilon \cdot \sqrt{\frac{2\Delta p}{\rho}}$$

D : Diameter of Pipe

$\beta$  : Bore to Diameter Ratio

$A_1$  : Cross Area of Pipe

$A_2$  : Reduced Cross Area

E : Approaching Velocity Coefficient

$\rho$  : Density of Flowing Fluid

d : Diameter of Cone

$c_d$  : Discharge Coefficient

m : Effectual Area Ratio

$\varepsilon$  : Expansion Coefficient

$\Delta p$  : Differential Pressure

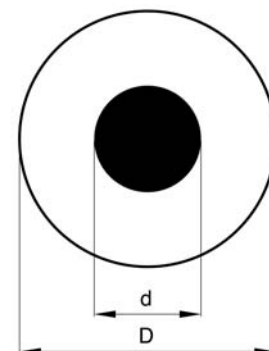
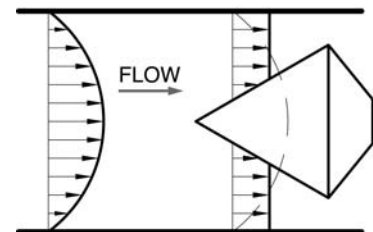

## Features

- High repeatability and accuracy
- Wide range for measuring fluids
- High Reliability due to no movement's part
- Short straight distance on both upstream and down stream
- Wide application for liquid, vapor and steam

## Complete Flow Loops

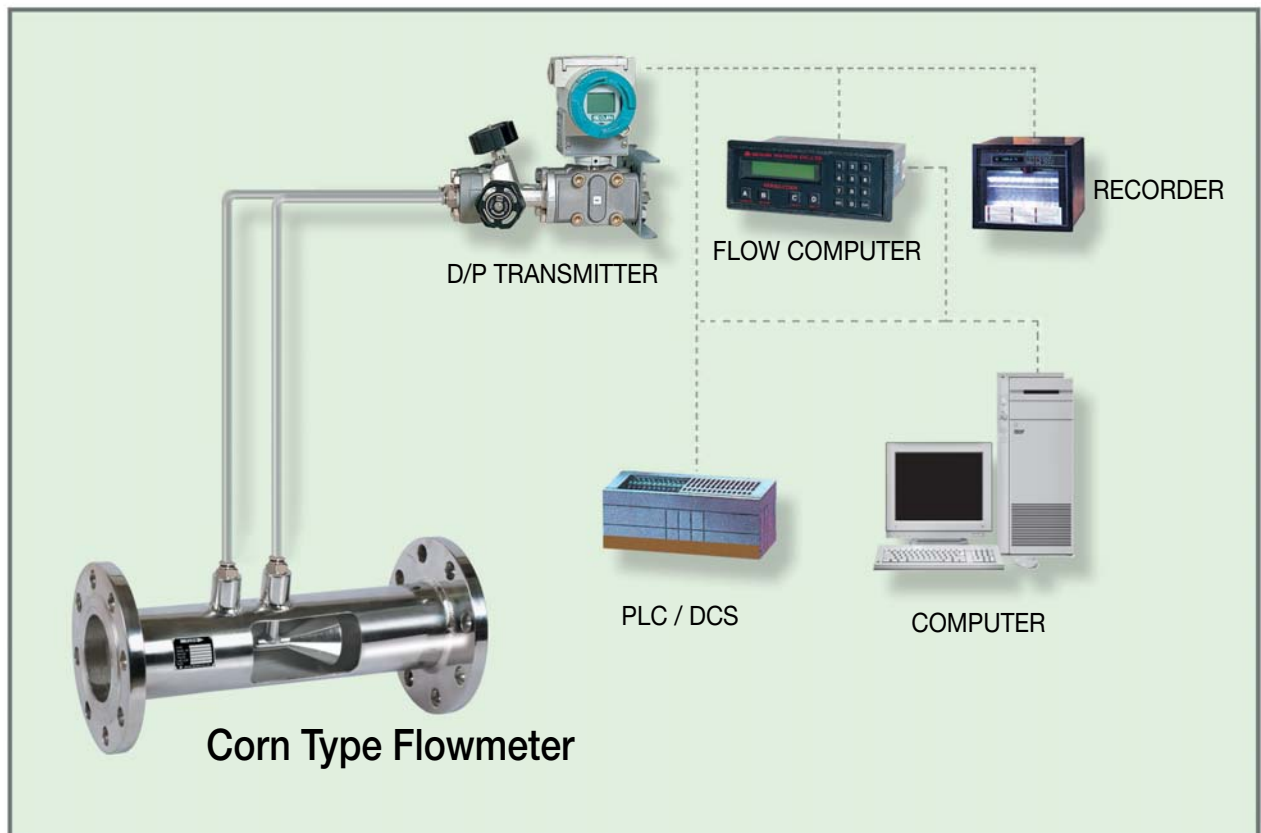

■ V-CONE TYPE FLOWMETER

SCF - A 1 A 1 A 1 A

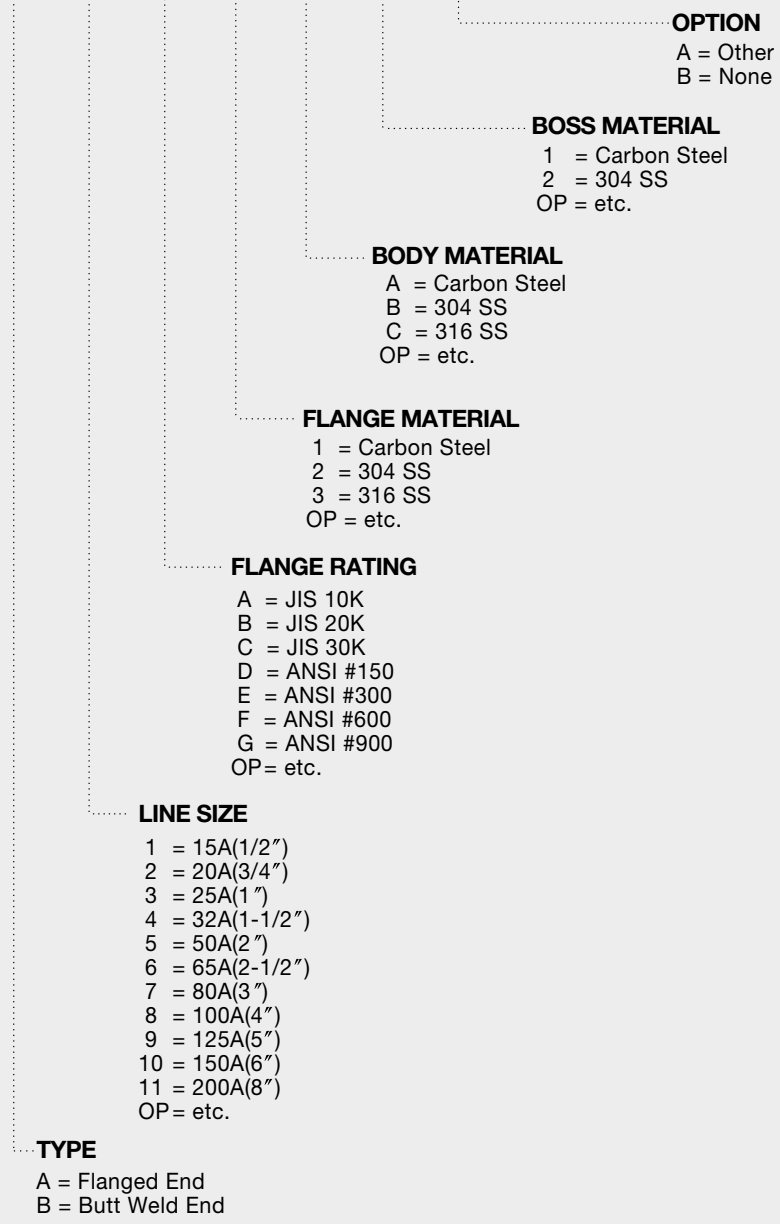

■ When placing an order, selected ordering number should be indicated on the purchase order sheet.